

**O**  
**BOOK**  
2019

**ORBEA**



**SINCE 1840**

NEVER GIVING UP.  
NEVER SETTLING FOR LESS.  
HARD WORK AND STRUGGLE RUNS IN OUR BLOOD.  
AND IN THE BLOOD OF ALL THE PEOPLE WHO SWEAT  
FOR US, WHO PEDAL FOR OUR BRAND.

WE'VE COME SO FAR...  
BUT WE WILL TRAVEL EVEN FURTHER.

THERE'S JUST ONE CONCLUSION TO DRAW:  
NO ONE WILL EVER CATCH UP WITH US.

**EVER.**



# CONTENTS

## 04

### ABOUT ORBEA

We are Orbea  
MyO  
Women  
Support

## 26

### MECHANICAL BIKES

28

#### ROAD

Orca Aero  
Orca  
Avant  
Terra

116

#### TRIATHLON

Ordu

134

#### MTB

Rallon / Occam  
Laufey / Oiz  
Alma / MX

234

#### URBAN

Katu / New Optima  
Carpe / Vector

266

#### LEISURE

Comfort

282

#### KIDS

Grow  
MX

## 312

### ELECTRIC BIKES

314

#### ROAD

Gain road  
Gain All road

336

#### MTB

Wild FS / Wild HT  
Keram MTB

376

#### URBAN

Gain Urban  
Katu-E  
Keram Asphalt /  
Keram Comfort  
Optima X35 /  
Optima Bosch Asphalt /  
Optima Bosch Comfort

## 420

### HELMETS

420

#### HELMETS

R10 Aero Mips  
R10 Mips  
R50  
M50  
H10  
Youth  
Kids



# ABOUT ORBEA

WE ARE ORBEA  
MYO  
WOMEN  
SUPPORT



## WE ARE ORBEA SINCE 1840

Orbea was established in 1840 as a family-run company making revolvers, shotguns and cartridges. With the outbreak of World War I, the company grew quickly. When the war ended, the firm changed business, focusing on the manufacture of precision mechanical products: prams, school desks and, finally, bicycles. Production soon reached as many as 50,000 a year.

A few years later, an economic crisis brought Orbea to the brink of bankruptcy. This would have meant doing away with the firm and with the jobs of 1,500 families. Showing once again that they weren't ready to give up, the workers talked the owner into transferring the business to them. The company became a cooperative, joining the Mondragon Cooperative Group in 1971. This way, they managed to keep their jobs and a brand with an already long history.





In 1975, the company moved its headquarters to the current location in Mallabia. At the new facilities, Orbea put in motion the idea of having a professional elite cycling team whose future members would include Perico Delgado – winner of the Vuelta a España 1985 – and Marino Lejarreta.. Although Orbea has always been associated with racing, it was only in 1982 that we became a sponsor of a professional road cycling team.

Later, with the emergence of mountain biking, Orbea launched an initiative that would change the brand and the industry for good - the first Orbea MTB team, led by Jokin Mujika, who won the Spanish Cyclo-Cross Championships in 1994.

With time, Orbea embarked on the process of internationalization, going beyond exclusive sales in Spain, first with exports to France and then with branches in the USA, France, Italy, the UK, Belgium, Germany, Australia and Portugal. The global strategy was divided into three areas: products, markets and brand. At present, we operate in more than 65 countries, developing and supplying around 160,000 bicycles, thousands of units of helmets and cycling wear, and planning trips and events.

Since the making of its first bike, Orbea has managed to adapt to changing conditions, offering quality products with innovative designs and materials.

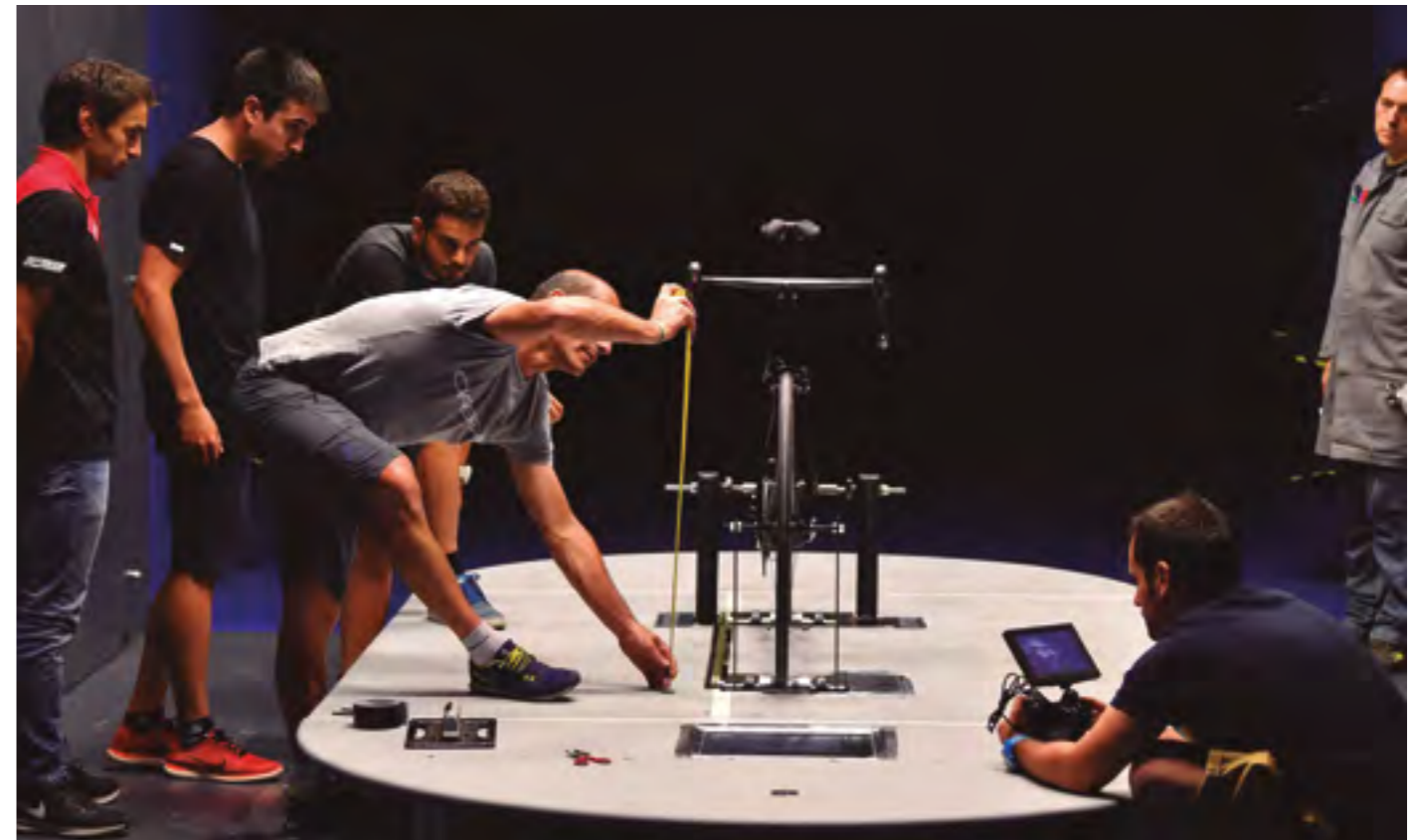

## OUR VALUES

### STRUGGLE AND UNIQUE ATTITUDE

At Orbea, we are fighters and non-conformists. Our ambition and that right touch of boldness mean that, in spite of being small, we are capable of great things.

We're not content with our current position, and that's why we take on new challenges that enable us to improve our position while defending the reputation we currently hold.

We are aware that we are not leaders, but we don't resign ourselves to where we are today. We want to continue to win small battles that show us to be important players in product categories with a high value in strategic markets.



### COMMITMENT AND HONESTY

For Orbea, the commitments we make to others (riders, dealers, suppliers, society and ourselves) are indisputable.

We are committed to offering riders the best solutions possible, standing by their side throughout the life of their products and also standing by them as they evolve in sports activities.

We are committed to dealers to grow and evolve together.

We are committed to our suppliers, to deliver on the agreements we reach.

We are committed to society, to give back as much as it has given us.

We are committed to ourselves, to stay true to our beliefs and honest in our propositions.



### PRIDE AND RELIABILITY

Orbea is a brand with a commitment to remain a manufacturer. With more than 175 years of history, we have established a unique way of doing things, a way of being and of accumulated knowledge that gives us the stability to take on challenges with ambition.

Because of this and because we are honest and committed, our customers and the market in general trust us.

We are proud of our past. We are defenders of our roots, which gave us values to which we remain loyal.

We are family to our friends, that's why our relationships are long-term. We defend and promote what we consider to be part of this family, whether it is our home, our dealers, our customers or our position in the market.

### EVOLUTION AND REINVENTION

Orbea is a brand in constant evolution - so much so that evolution has become an attitude for us, and the market demands it from our brand.

This attitude of evolution sometimes leads us to changes that are so profound that we can often say that we have reinvented ourselves, surprising ourselves and others in the process.

### PROXIMITY AND PEOPLE

Orbea is a brand and a company that exists thanks to so many people. Different diverse people who are a true reflection of our society and our market. We are passionate about cycling and we are proud of our work, and we express this with excitement and enthusiasm.

We are a cooperative, and we are used to sharing both our successes and failures. This capacity for sharing is what gives us our proximity to our customers, actively listening to what the market expects of us.





## ORBEA MYO DESIGN YOUR RIDE

Throughout our more than 175-year history, customization has always been one of our primary weapons. Ever since we started manufacturing bicycles, our objective has remained unchanged: to make sure that you can pedal a creation that is exactly what you want.

Every rider is unique. We all know that looking for the same type of bicycle does not mean that we have the same bike in mind... or the same needs. There are riders who take out their road bike seven days a week, and others who enjoy a simpler, relaxed weekend adventure. There are those who put our MTBs through the most impossible trail rides, and others who prefer to enjoy the freedom of the mountains in more relaxed terrain. There are riders who prefer to invest in the drivetrain, while others prefer to have the latest fork on the market. Some are looking for the lowest weight when putting together the bike components, while others are considering whether to have one or two chainrings.

In the end, what's important is that the bicycle is built just how you want it: selecting from different gearing, wheel and saddle options to choose those that best match how you want to ride. In short, you can go as far as you want with the customization of your bicycle. This is MyO, our commitment to deliver the exact bicycle you need, just like you've designed it, either at [orbea.com](http://orbea.com) or with the advice of your Orbea distributor.





## A DIFFERENT WAY OF DOING THINGS

Orbea's industrial model is what makes it possible to provide this level of customization and flexibility, at no added cost for the user. Orbea is not a bike warehouse. We are bicycle manufacturers, we have industry-leading painting and assembly facilities, and above all, highly qualified people who excel in every step of the process.

Those who paint and assemble your customized bicycle entirely at our headquarters in Mallabia are also huge bike fans and are company owners. That's why, in some ways, every MyO bicycle bears their name as well as yours.

Of all Orbea bicycles already have a recipient when they are manufactured. Our planning is 100% revised on a weekly basis, and our production is scheduled every day: we only manufacture what has been requested by our dealers and bicycles that you have ordered from us through MyOrbea.

This model is more sustainable for everyone. As a customer, you know that your bike is not mass-produced on a production line, rather something created exclusively for you. That's why it is very likely that you'll form a special emotional bond with it that will cause you to take better care of it and try to make it last as long as possible.

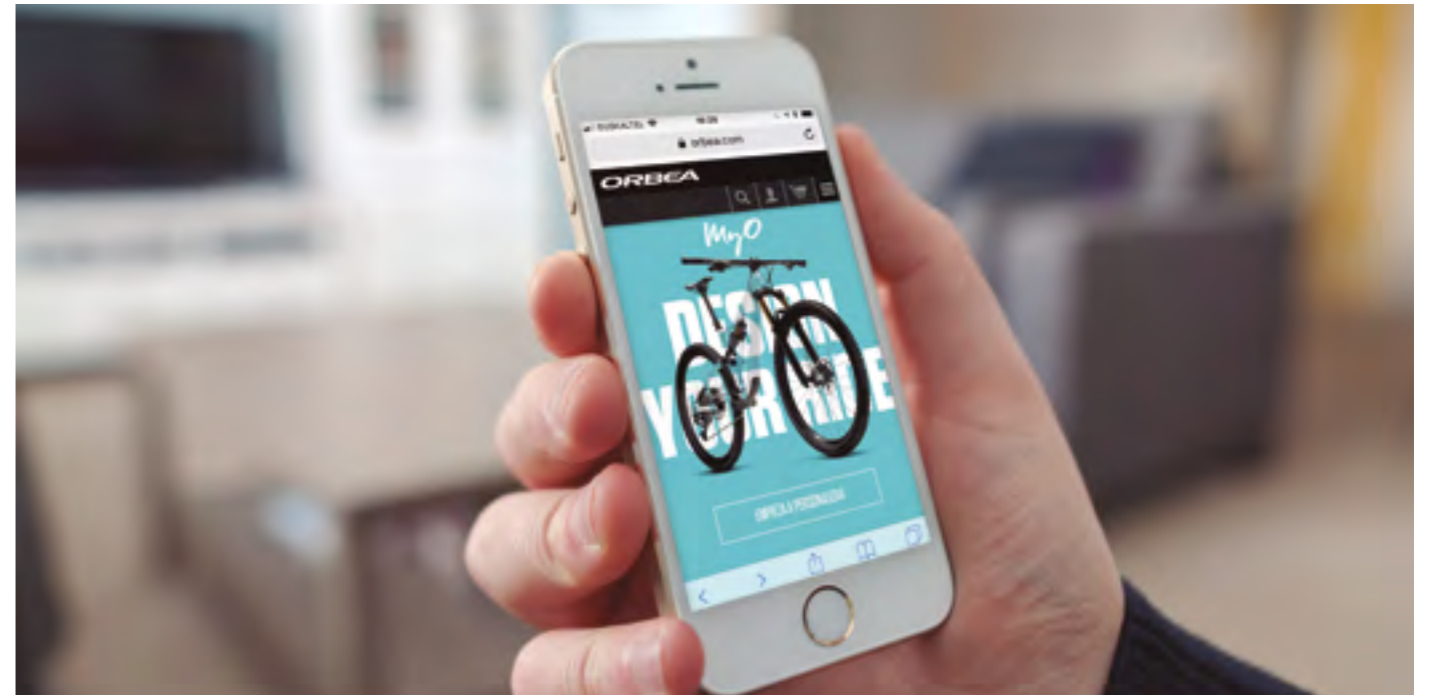

The dealer, as always, is an essential part of the equation. First of all, because their expertise will be very useful when deciding which components best match your needs and how you are going to use your bike. But even if you customize it yourself and pick it up at the store, you'll continue to visit the dealer who will follow the evolution of your bicycle throughout its service life (providing adjustments advice, spare parts, etc.).

For us, MyO and MyO Lite are an association that we have built with you and with many other cyclists around the world. It's a way of working that inspires us to fulfill your most exclusive desires, or just simply to build exactly the bicycle that you need.





## WOMEN

Orbea doesn't make women's bicycles, we make bikes women ride. The women of UHC Pro Cycling Team win on the same Orbeas raced in World Tour races by the men of Team Vital Concept. Two-time XC World Champion Catherine Pendrel of the CLIF Pro Team has never requested a woman's bike, she instead demands we design the best mountain bikes on the market.

The heart of the bicycle is wonderfully universal - a machine designed for humans. With this in mind, we create a custom experience for every rider - stems, bars, saddles and color can be selected to suit any body shape, riding style and aesthetic preference. When you choose Orbea you're saying 'no' to the standard bike-in-a-box and selecting one of the best bikes available, period.



### CUSTOMIZE NOT COMPROMISE

Are you a shorter man who plans to ride 15,000k on the road this season? Are you a taller woman who hopes to race mountain bikes competitively? We have models, sizes and component options that will turn your Orbea into an extension of your body no matter your size. Check out our our Bike Fit Finder online to see which size we suggest or visit your Orbea dealer for a test ride and ask an Orbea fit expert about customizing an Orbea for YOU.

### FINDING THE PERFECT FIT

The most important aspects of a custom fit are the contact points, the components that you touch while riding. Orbea offers narrow handlebars to fit slender shoulders and shorter or longer stems to accommodate differing torso and arm lengths. Saddles are available to fit women better, and crank length can be selected to proportionately match leg length. Don't know what you need? Our online Fit Calculator or your Orbea Dealer can help you decide.



### MYO LITE

Purchasing a new bike can be daunting. Frame size, wheel size, intended use and gender-specific options compete for attention and everywhere we hear the term "proper fit." Buying the wrong size shoes is disappointing enough - the idea of spending \$4000 on the wrong bike can be paralyzing. That's why Orbea encourages you to take advantage of our MyO Program to

customize component and fit options with your Orbea dealer before you even order. No matter what Orbea you are considering, we can take it beyond a stock "one size fits all" machine and adapt it perfectly to your distinct form and style with no shortcuts and no compromises.



### MORPHOLOGY

We can make general observations or predictions about the human body, but there are no hard rules - what works for one rider might not be good for another. We all know two friends of the same height that obviously have different body types. Generally though, the contact points of the bicycle are able to accommodate almost any shape. Stem length and height can be changed for torso and arm length, a rider's shoulder width dictates how wide the handlebars should be, and crank

length can be varied based on inseam. Saddles are designed for the width of the "sit bones" and while women generally have wider sit bones, there are plenty of men out there who could also benefit from a wider saddle. Because of this natural variation and our desire to customize your bike exactly for you, we offer components to help you get your Orbea just right.

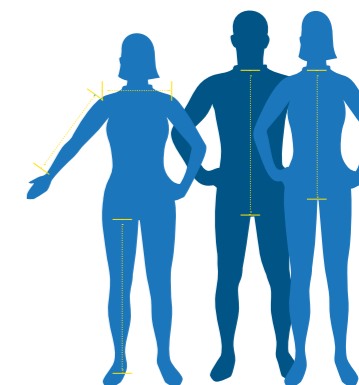



## ORBEA WARRANTY WITH THE MOST ADVANTAGES

### BENEFIT FROM THESE ADDITIONAL ADVANTAGES BY REGISTERING YOUR BICYCLE SERIAL NUMBER.

#### LIFETIME WARRANTY

Extend your standard regional warranty with Orbea's Lifetime Warranty, which provides more complete coverage.

Orbea is pleased to offer you a lifetime warranty once your limited warranty term has ended, according to the conditions described below.

#### COVERAGE

To complement the Legal Warranty, ORBEA offers all users Orbea's Lifetime Warranty, which is completely voluntary and free of charge. It consists of a lifetime warranty with no time limitations that covers all frames and rigid forks on our bicycles against breaking and/or cracks.

Orbea's Lifetime Warranty will also extend coverage against paint, varnish and corrosion defects on all frames and rigid forks for 1 additional year after the end of the legal warranty (in other words, for up to 3 years after the purchase of the product by the user).

When filing a claim under Orbea's Lifetime Warranty, the buyer shall have the right to the repair and/or replacement of any broken or cracked frames and/or rigid forks.

#### ACCIDENT POLICY

We offer an Accident policy for several of our models, with discounts for replacing or repairing your frame.

In the case of a broken or cracked frame resulting from external factors not related to manufacturing defects, we offer a discount on a new, similar frame, according to the following conditions:

- 0-12 months:**  
50% off retail price.
- 13-24 months:**  
40% off retail price.
- 25-36 months:**  
30% off retail price.

Service available for OME, OMP, OMR and Rallon frames.

To activate your extended warranty, please register your bike within 30 days of purchase. You will need your purchase invoice, too.

To register your bike, go to:  
[www.orbea.com/warranties](http://www.orbea.com/warranties)

#### HOW TO FIND IT ON YOUR BIKE





## KIDE AN EXCLUSIVE AREA

OUR 'COMPANION' FOR ORBEA DEALERS TO QUICKLY ACCESS AND MANAGE ACCOUNTS.

### PRE-SALES

- / Information about model availability.
- / Questions about the range.

### SALES

- / Order processing and entry into the system.
- / Invoice status.
- / Payment status.

### AFTER-SALES

- / Technical questions.
- / Warranty management.
- / Accident policy.
- / Replacement part sales.

### ADVANTAGES

- / Shorter order management times.
- / Multiple users for the same store.
- / Permissions adapted to each user.
- / Each color option is presented with the photo of the bike in that color.
- / Simple tracking of bikes purchased online in the store.
- / Ability to identify each order with the user who has purchased it.
- / Suitable for showing the range and prices to the user.

24/7 AVAILABILITY,  
YEAR-ROUND



## CLICK&COLLECT

START TO SELL ONLINE WITH ORBEA C&C

### 01 ORDER



- / The online customer places the order on the website and pays online.
- / The customer selects the C&C point to pick up the bicycle.
- / The C&C point receives the order confirmation with the customer's information.

### 02 ASSEMBLY



- / C&C point receive the bike.
- / C&C calls the buyer to make an appointment for pickup within 48 hours.
- / C&C point professionally assembles and adjusts the bike.

### 03 DELIVERY



- / Delivery of the assembled and adjusted bike to the customer.
  - Order confirmation email and ID.
  - Invoice signature.
- / Send the registration reminder.
- / Invite the customer to come in for a general inspection.

### 04 RETURNS



- / The customer can return the bike within a period of 15 days.
- / The C&C point must manage the returns and claims.
- / Bikes must be returned in the same condition as when they were delivered:
  - Unused.
  - Original assembly.
  - With documentation and stickers.
- / After reviewing the delivery conditions, the C&C point contacts Orbea to manage the return and the credit (minus the shipping costs).  
online.es@orbea.com
- / Orbea does not accept any returns of customized products (myo and options).

“MORE THAN 1500 ORBEA C&C POINTS AROUND THE WORLD ARE **GAINING SALES AND CUSTOMERS** BY PARTICIPATING IN THE C&C PROGRAM.

“C&C POINTS ARE **ORBEA RETAILERS** THAT ARE AUTHORIZED TO ASSEMBLE AND DELIVER C&C BIKES

## WOULD YOU LIKE TO BECOME AN ORBEA C&C DEALER?

Contact your sales representative or send us an email at [online.es@orbea.com](mailto:online.es@orbea.com)

1. SIGN THE CLICK&COLLECT CONTRACT

2. OFFER A QUALITY EXPERIENCE TO YOUR NEW CUSTOMERS

3. SEND US A GREAT PICTURE OF YOUR STORE AND ITS LOCATION FOR PUBLICATION ON OUR WEBSITE





# MECANICAL BIKES

ROAD  
TRIATHLON  
MTB  
URBAN  
LEISURE  
KIDS



# ROAD

ORCA AERO  
ORCA  
AVANT  
TERRA





## NEVER MIND MARGINAL GAINS

Chase small improvements in every aspect of your riding, but don't overlook the massive advantage offered by Orca Aero. A bike that doesn't just cheat the wind but openly defies it – an ode to efficiency and stiffness that relishes the assault of a 1700 watt finish – Orca Aero is the perfect accomplice for riders who aspire to become more familiar with the podium. Do battle off the front while others hide in the wheels, vanquished. Take pulls. Love the gutter. Find unknown strength in a machine designed for glory and hoard it for that single moment when you seize your opportunity. Marginal gains are for those playing the long game - Orca Aero would rather take the win today.

**ORCA AERO**

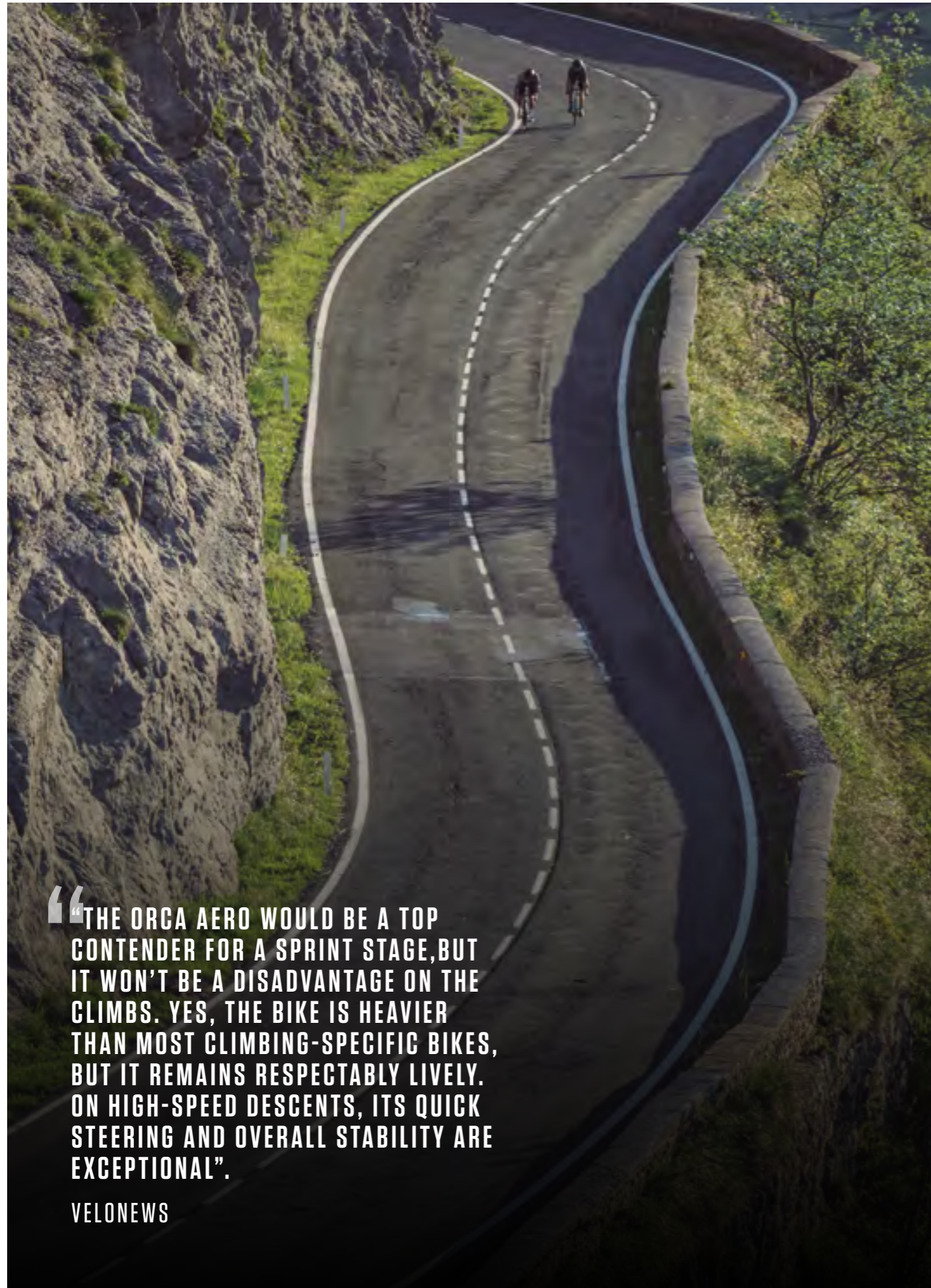

“THE ORCA AERO WOULD BE A TOP CONTENDER FOR A SPRINT STAGE, BUT IT WON'T BE A DISADVANTAGE ON THE CLIMBS. YES, THE BIKE IS HEAVIER THAN MOST CLIMBING-SPECIFIC BIKES, BUT IT REMAINS RESPECTABLY LIVELY. ON HIGH-SPEED DESCENTS, ITS QUICK STEERING AND OVERALL STABILITY ARE EXCEPTIONAL”.

VELONEWS



## USER

The Orca Aero rider is a powerful athlete most concerned about aerodynamic efficiency and saving watts. It's a scientific numbers-oriented rider more than a slender climbing specialist who counts each gram of weight.

This rider is attracted to integrated features and a balanced design that doesn't compromise stiffness.

# ORCA AERO TECH



01 AERODYNAMICS

02 STIFFNESS

03 INTEGRATION

04 MYO

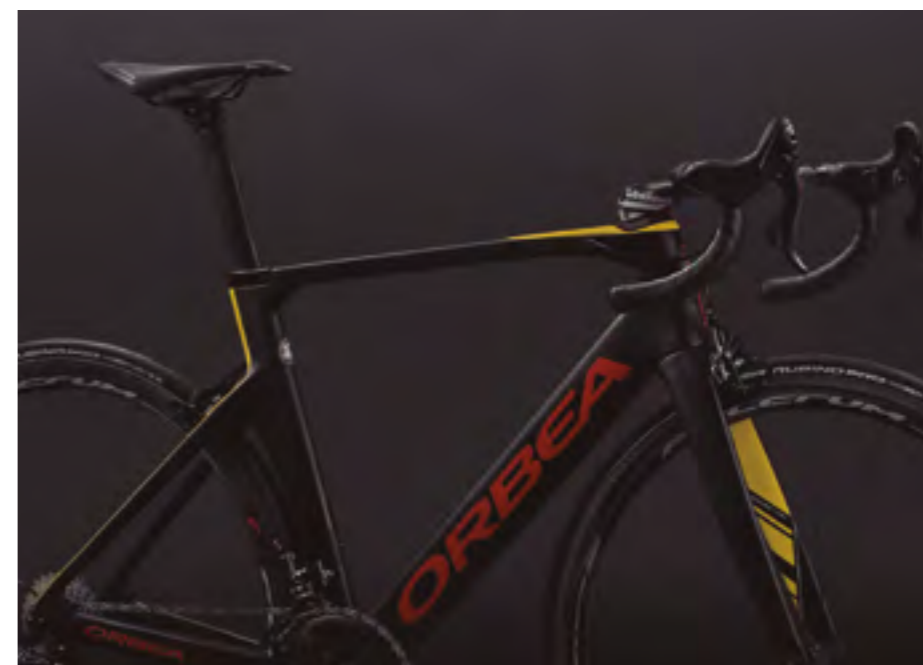

“BRILLIANT HANDLING DYNAMICS SET THE ORCA AERO APART FROM YOUR AVERAGE AERO BIKE”.

BIKERADAR

## AERODYNAMIC NEW FREEFLOW FORK

The wider fork opening reduces airflow pressure via the wheel and the fork achieving a 4 watt drag reduction. The new UCI legal fork designed according to the new regulations, provides all competitors with a 3:1 advantage ratio.

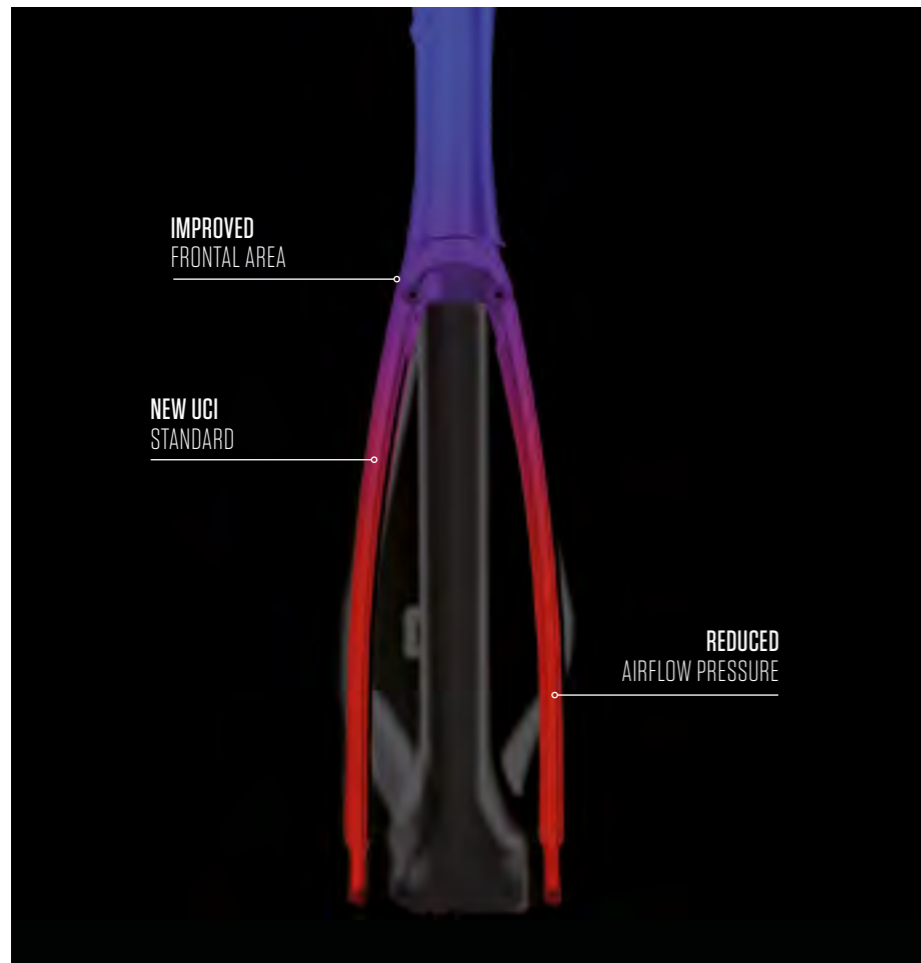

## SHORTENED TAIL

Enables the use of flatter tubing, which softens the airflow towards the bottle cages.

## DOUBLE RADIUS

Opens up airflow around the tubing profile, with improved airflow over the different angles.

## FLATTENED SIDES

Reduces friction at the front of the tubing and provides better drag at low speeds.

## ORCA AERO SEAT POST

The Orca Aero has an oval seat post designed to reduce air turbulence, without impairing its vibration absorption capabilities. The seat post is adjustable, and employs a system that enables a greater range of saddle adjustment positions, unlike the competition.

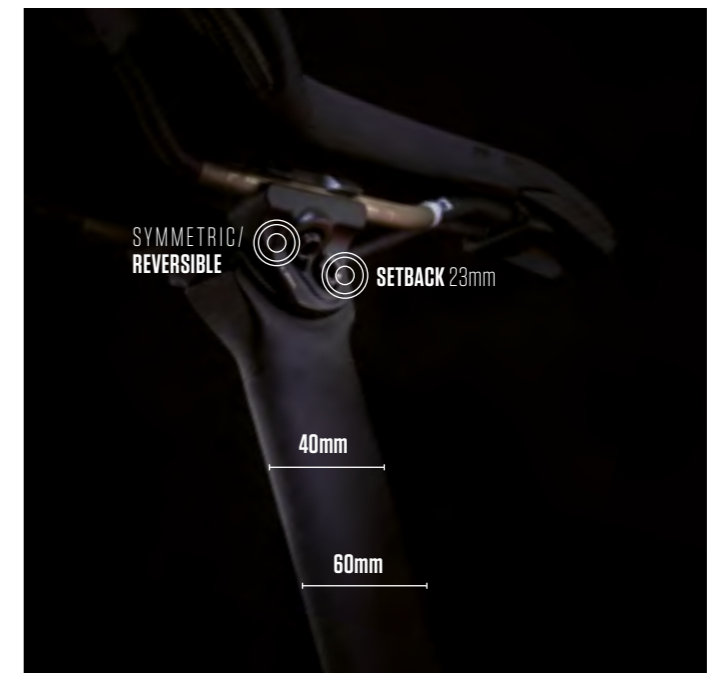

## RIGID STRUCTURE

The head tube, bottom bracket and chainstay joints are optimized for improved torsional strength. The sections have been optimized for each size frame to create a more rigid structure.

## POWER TRANSMISSION

A more rigid Orca Aero means improved transmission of power from the cyclist.



ORCA AERO	125
	120
	115
	110
	106
ORCA AERO DISC	104
	102
	100
ORCA OMR	96
ORCA DISC OMR	94
	92
AVANT DISC	90
	88
	86
	84
	NM/°



## DISC BRAKE

Disc brake mounting system is the Flat Mount standard for the best compatibility, lowest profile and clean appearance.

Front and rear through axles provide unparalleled rigidity and security. A completely enclosed axle placement provides an incredibly stable caliper/rotor interface. 142x12mm rear and 100x12mm front axles are the most widely-adopted specification for road disc, meaning component choice won't be limited by a proprietary axle system.



## INTEGRATION SIMPLICITY

The specific design enables the integrated handlebars to be easily adapted.

## COMPATIBILITY

Our system enables different power - handlebar options to be selected, which are perfectly integrated.

## ICR PLUS

ICR (Internal Cable Routing) has been conceived to ensure the best internal cable guidance: friction-free, easy to install and low maintenance. The ICR + system is compatible with both mechanical and electronic and wireless transmissions. The same frame is compatible with all transmission systems.



## MMS

The Orca Aero is characterized by its versatility and intelligent design. The multiple bottle cage mounts and three bosses provide several configuration options, to improve aerodynamics or improve the distribution of the bike's center of gravity.



MyO

# DESIGN YOUR BIKE







- 01 CHOOSE A MODEL AND SELECT OR SUBSTITUTE YOUR FAVORITE COMPONENTS.
- 02 CREATE A CUSTOM PAINT SCHEME.
- 03 ADD YOUR NAME TO THE TOPE TUBE.

[WWW.ORBEA.COM](http://WWW.ORBEA.COM)

# ORCA AERO DB

SIZES	47	49	51	53	55	57	60
1 - Seat Tube (C-T)	450	465	490	515	535	555	580
2 - Top Tube (EFF)	509	521	534	547	559	575	588
3 - Head Tube	100	108	124	144	163	181	208
4 - Chainstay	408	408	408	408	408	408	408
5 - BB Height	269,5	269,5	269,5	271,5	271,5	271,5	271,5
6 - BB Drop	72	72	72	70	70	70	70
7 - Wheelbase	970	974	978	980	991	1000	1014
8 - Head Angle	71°	71.5°	72.2°	72.8°	73°	73.2°	73.2°
9 - Seat Angle	74.5°	74°	73.7°	73.5°	73.5°	73.2°	73.2°
10 - Standover	464,9	478,5	499,2	516,1	540	558,2	582,6
11 - Reach	370	375	380	385	391	398	404
12 - Stack	501	510	528	548	567	585	611
13 - Fork Length	370	370	370	370	370	370	370

HEIGHT (cm)	HEIGHT (in)	SIZE
155-160	61.1"-63.0"	47
160-166	63.0"-65.4"	49
167-172	65.7"-67.7"	51
173-179	68.1"-70.5"	53
180-185	70.9"-72.8"	55
186-191	73.2"-75.2"	57
192-207	75.6"-81.5"	60

-  Steel Black (Matt-Gloss)  
**A8**
-  Red-Black (Matt)  
**AK**
-  Black-Red (Matt)  
**AL**
-  Blue (Gloss)  
**AM**
-  Perla-Silver (Matt)  
**AN**
-  MyO  
**CM**

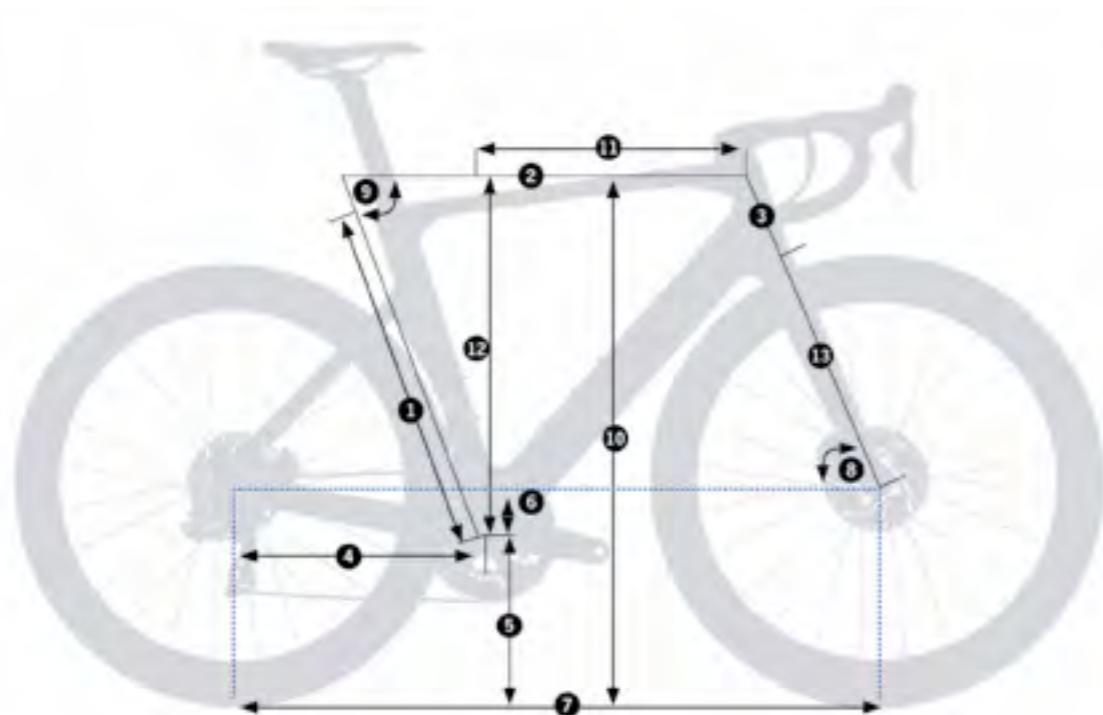

# ORCA AERO M10I TEAM-D MyO

Code	J157		
Size	Crank	Stem	Handlebar
47	170	100	400
49	170	100	420
51	170	100	420
53	170	110	420
55	172	110	420
57	172	120	420
60	175	120	420

- 
- 
- 
- 
- 
- 

<b>Frame</b>	Orbea Orca Aero carbon OMR disc, monocoque construction, tapered 1-1/8" - 1,5", BB 386mm, powermeter compatible, Thru Axle 12mm x 142mm rear, internal cable routing, EC/DC compatible, 27,2mm seat tube
<b>Fork</b>	Orca Aero carbon OMR disc fork, full carbon steerer, tapered 1-1/8" - 1,5", carbon dropouts Thru axle 12mm x 100m
<b>Crankset</b>	Shimano Dura-Ace 9100 34x50t Shimano Dura-Ace R9100 39x53t Rotor Aldhu 36x52t Rotor 2INpower DM 34x50t Rotor 2INpower DM 36x52t
<b>Headset</b>	FSA 1-1/8 - 1-1/2" Integrated Carbon Cup ACB Bearings
<b>Handlebar</b>	Vision Metron 5D Compact



<b>Handlebar Plugs</b>	Black Anti-Slippery/Shock Proof Bar Tape
<b>Stem</b>	FSA Metron 5D Compact Handlebar integrated
<b>Shifters</b>	Shimano R9170
<b>Brakes</b>	Shimano R9170 Hydraulic Disc
<b>Rear Derailleur</b>	Shimano Dura-Ace 9150 Di2
<b>Front Derailleur</b>	Shimano Dura-Ace 9150 Di2
<b>Chain</b>	Shimano HG901-11
<b>Wheels</b>	DT ARC 1400 Dicut DB 48 Carbon CL TL Fulcrum Racing Quattro Carbon DB DT Swiss ER1600 Spline 32
<b>Cassette</b>	Shimano Dura-Ace 9100 11-28t 11-Speed

<b>Tyres</b>	Hutchinson Fusion 5 All Season TLR 700x25 Hutchinson Fusion 5 All Season TLR 700x28
<b>Pedals</b>	N/A
<b>Seatpost</b>	Orbea Aero OMR
<b>Saddle</b>	Prologo Dimension T4,0 size 143 mm Prologo Scratch-2 Tirox size 143 mm Black Selle Italia SLR Kit Carbonio Black

# ORCA AERO M10 TEAM-D MyO

Code	J156		
Size	Crank	Stem	Handlebar
47	170	90	400
49	170	100	400
51	170	100	420
53	170	110	420
55	172	110	420
57	172	110	440
60	175	120	440

- 
- 
- 
- 
- 
- 

<b>Frame</b>	Orbea Orca Aero carbon OMR disc, monocoque construction, tapered 1-1/8" - 1,5", BB 386mm, powermeter compatible, Thru Axle 12mm x 142mm rear, internal cable routing, EC/DC compatible, 27,2mm seat tube
<b>Fork</b>	Orca Aero carbon OMR disc fork, full carbon steerer, tapered 1-1/8" - 1,5", carbon dropouts Thru axle 12mm x 100m
<b>Crankset</b>	Shimano Dura-Ace 9100 34x50t Shimano Dura-Ace R9100 39x53t Rotor Aldhu 36x52t Rotor 2INpower DM 34x50t Rotor 2INpower DM 36x52t
<b>Headset</b>	FSA 1-1/8 - 1-1/2" Integrated Carbon Cup ACB Bearings
<b>Handlebar</b>	Vision Metron 4D Compact



<b>Handlebar Plugs</b>	Black Anti-Slippery/Shock Proof Bar Tape
<b>Stem</b>	Orbea OC-III
<b>Shifters</b>	Shimano R9120
<b>Brakes</b>	Shimano R9170 Hydraulic Disc
<b>Rear Derailleur</b>	Shimano Dura-Ace 9100
<b>Front Derailleur</b>	Shimano Dura-Ace 9100
<b>Chain</b>	Shimano HG901-11
<b>Wheels</b>	DT ER 1600 Spline DB 32 CL TL Fulcrum Racing Quattro Carbon DB DT Swiss ARC1400 Dicut 48 DB
<b>Cassette</b>	Shimano Dura-Ace 9100 11-28t 11-Speed Shimano Dura-Ace R9100 11-25t 11-Speed

<b>Tyres</b>	Hutchinson Fusion 5 All Season TLR 700x25 Hutchinson Fusion 5 All Season TLR 700x28
<b>Pedals</b>	N/A
<b>Seatpost</b>	Orbea Aero OMR
<b>Saddle</b>	Prologo Dimension T4,0 size 143 mm Prologo Scratch-2 Tirox size 143 mm Black Selle Italia SLR Kit Carbonio Black

## ORCA AERO M20I TEAM-D

Code	J155		
Size	Crank	Stem	Handlebar
47	170	90	400
49	170	100	400
51	170	100	420
53	170	110	420
55	172	110	420
57	172	110	440
60	175	120	440



<b>Frame</b>	Orbea Orca Aero carbon OMR disc, monocoque construction, tapered 1-1/8" - 1,5", BB 386mm, powermeter compatible, Thru Axle 12mm x 142mm rear, internal cable routing, EC/DC compatible, 27,2mm seat tube
<b>Fork</b>	Orca Aero carbon OMR disc fork, full carbon steerer, tapered 1-1/8" - 1,5", carbon dropouts Thru axle 12mm x 100m
<b>Crankset</b>	Shimano Ultegra R8000 34x50t Rotor Aldhu 36x52t Rotor 2INpower DM 34x50t Rotor 2INpower DM 36x52t Shimano Ultegra R8000 39x53t
<b>Headset</b>	FSA 1-1/8 - 1-1/2" Integrated Carbon Cup ACB Bearings
<b>Handlebar</b>	FSA Trimax Compact



	Vision Metron 5D Compact
	Vision Metron 4D Compact
<b>Handlebar Plugs</b>	Black Anti-Slippery/Shock Proof Bar Tape
<b>Stem</b>	Orbea OC-III
<b>Shifters</b>	Shimano ST-8070
<b>Brakes</b>	Shimano R8070 Hydraulic Disc
<b>Rear Derailleur</b>	Shimano Ultegra Di2 R8050 SS
<b>Front Derailleur</b>	Shimano Ultegra Di2 R8050
<b>Chain</b>	KMC X11-EL
<b>Wheels</b>	FULCRUM Racing 400 DB Fulcrum Racing Quattro Carbon DB DT Swiss ER1600 Spline 32 DT Swiss ARC1400 Dicut 48 DB

<b>Cassette</b>	Shimano Ultegra R8000 11-28t 11-Speed Shimano Ultegra R8000 11-25t 11-Speed Shimano Ultegra R8000 11-30t 11-Speed
<b>Tyres</b>	Vittoria Rubino Foldable 700x25 60TPI G+ Hutchinson Fusion 5 All Season TLR 700x28 Hutchinson Fusion 5 All Season TLR 700x25
<b>Pedals</b>	N/A
<b>Seatpost</b>	Orbea Aero OMR
<b>Saddle</b>	Prologo Dimension T4,0 size143 mm Prologo Scratch-2 Tirox size 143 mm Black Selle Italia SLR Kit Carbonio Black

## ORCA AERO M30 TEAM-D

Code	J153		
Size	Crank	Stem	Handlebar
47	170	90	400
49	170	100	400
51	170	100	420
53	170	110	420
55	172	110	420
57	172	110	440
60	175	120	440



<b>Frame</b>	Orbea Orca Aero carbon OMR disc, monocoque construction, tapered 1-1/8" - 1,5", BB 386mm, powermeter compatible, Thru Axle 12mm x 142mm rear, internal cable routing, EC/DC compatible, 27,2mm seat tube
<b>Fork</b>	Orca Aero carbon OMR disc fork, full carbon steerer, tapered 1-1/8" - 1,5", carbon dropouts Thru axle 12mm x 100m
<b>Crankset</b>	Shimano 105 R7000 34x50t Rotor Aldhu 36x52t Rotor 2INpower DM 34x50t Rotor 2INpower DM 36x52t Shimano 105 R7000 39x53t
<b>Headset</b>	FSA 1-1/8 - 1-1/2" Integrated Carbon Cup ACB Bearings
<b>Handlebar</b>	FSA Trimax Compact



	Vision Metron 5D Compact
	Vision Metron 4D Compact
<b>Handlebar Plugs</b>	Black Anti-Slippery/Shock Proof Bar Tape
<b>Stem</b>	Orbea OC-III
<b>Shifters</b>	Shimano ST-7020
<b>Brakes</b>	Shimano R7070 Hydraulic Disc
<b>Rear Derailleur</b>	Shimano 105 R7000 SS
<b>Front Derailleur</b>	Shimano 105 R7000
<b>Chain</b>	KMC X11-EL
<b>Wheels</b>	FULCRUM Racing 400 DB Fulcrum Racing Quattro Carbon DB DT Swiss ER1600 Spline 32 DT Swiss ARC1400 Dicut 48 DB

<b>Cassette</b>	Shimano 105 R7000 11-28t 11-Speed Shimano 105 R7000 11-30t 11-Speed Shimano 105 R7000 11-32 11-Speed (RD GS)
<b>Tyres</b>	Vittoria Rubino Foldable 700x25 60TPI G+ Hutchinson Fusion 5 All Season TLR 700x28 Hutchinson Fusion 5 All Season TLR 700x25
<b>Pedals</b>	N/A
<b>Seatpost</b>	Orbea Aero OMR
<b>Saddle</b>	Prologo Dimension T4,0 size143 mm Prologo Scratch-2 Tirox size 143 mm Black Selle Italia SLR Kit Carbonio Black

## ORCA AERO M20 TEAM-D

Code	J154		
Size	Crank	Stem	Handlebar
47	170	90	400
49	170	100	400
51	170	100	420
53	170	110	420
55	172	110	420
57	172	110	440
60	175	120	440



<b>Frame</b>	Orbea Orca Aero carbon OMR disc, monocoque construction, tapered 1-1/8" - 1,5", BB 386mm, powermeter compatible, Thru Axle 12mm x 142mm rear, internal cable routing, EC/DC compatible, 27,2mm seat tube
<b>Fork</b>	Orca Aero carbon OMR disc fork, full carbon steerer, tapered 1-1/8" - 1,5", carbon dropouts Thru axle 12mm x 100m
<b>Crankset</b>	Shimano Ultegra R8000 34x50t Rotor Aldhu 36x52t Rotor 2INpower DM 34x50t Rotor 2INpower DM 36x52t Shimano Ultegra R8000 39x53t
<b>Headset</b>	FSA 1-1/8 - 1-1/2" Integrated Carbon Cup ACB Bearings
<b>Handlebar</b>	FSA Trimax Compact



	Vision Metron 5D Compact
	Vision Metron 4D Compact
<b>Handlebar Plugs</b>	Black Anti-Slippery/Shock Proof Bar Tape
<b>Stem</b>	Orbea OC-III
<b>Shifters</b>	Shimano ST-8020
<b>Brakes</b>	Shimano R8070 Hydraulic Disc
<b>Rear Derailleur</b>	Shimano Ultegra R8000 SS
<b>Front Derailleur</b>	Shimano Ultegra R8000
<b>Chain</b>	KMC X11-EL
<b>Wheels</b>	FULCRUM Racing 400 DB Fulcrum Racing Quattro Carbon DB DT Swiss ER1600 Spline 32 DT Swiss ARC1400 Dicut 48 DB







<b>Cassette</b>	Shimano Ultegra R8000 11-28t 11-Speed Shimano Ultegra R8000 11-25t 11-Speed Shimano Ultegra R8000 11-30t 11-Speed
<b>Tyres</b>	Vittoria Rubino Foldable 700x25 60TPI G+ Hutchinson Fusion 5 All Season TLR 700x28 Hutchinson Fusion 5 All Season TLR 700x25
<b>Pedals</b>	N/A
<b>Seatpost</b>	Orbea Aero OMR
<b>Saddle</b>	Prologo Dimension T4,0 size143 mm Prologo Scratch-2 Tirox size 143 mm Black Selle Italia SLR Kit Carbonio Black



# ORCA AERO

SIZES	47	49	51	53	55	57	60
1 - Seat Tube (C-T)	450	465	490	515	535	555	580
2 - Top Tube (EFF)	509	521	534	547	559	575	588
3 - Head Tube	100	108	124	144	163	181	208
4 - Chainstay	408	408	408	408	408	408	408
5 - BB Height	269,5	269,5	269,5	271,5	271,5	271,5	271,5
6 - BB Drop	72	72	72	70	70	70	70
7 - Wheelbase	970	974	978	980	991	1000	1014
8 - Head Angle	71°	71.5°	72.2°	72.8°	73°	73.2°	73.2°
9 - Seat Angle	74.5°	74°	73.7°	73.5°	73.5°	73.2°	73.2°
10 - Standover	464,9	478,5	499,2	516,1	540	558,2	582,6
11 - Reach	370	375	380	385	391	398	404
12 - Stack	501	510	528	548	567	585	611
13 - Fork Length	370	370	370	370	370	370	370

HEIGHT (cm)	HEIGHT (in)	SIZE
155-160	61.1"-63.0"	47
160-166	63.0"-65.4"	49
167-172	65.7"-67.7"	51
173-179	68.1"-70.5"	53
180-185	70.9"-72.8"	55
186-191	73.2"-75.2"	57
192-207	75.6"-81.5"	60

-  Steel Black (Matt-Gloss) A8
-  Red-Black (Matt) AK
-  Black-Red (Matt) AL
-  Blue (Gloss) AM
-  Perla-Silver (Matt) AN
-  MyO CM

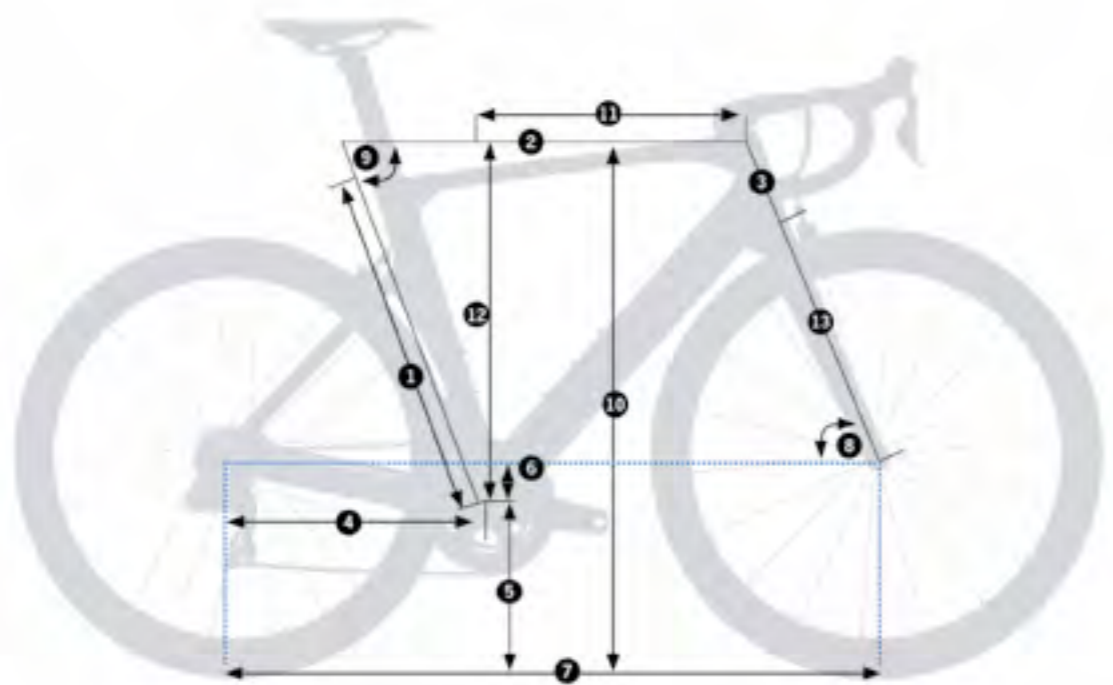

# ORCA AERO M111 TEAM

Code	J151		
Size	Crank	Stem	Handlebar
47	170	100	400
49	170	100	400
51	170	100	420
53	170	110	420
55	172	110	420
57	172	120	420
60	175	120	420



<b>Frame</b>	Orbea Orca Aero carbon OMR, monocoque construction, tapered 1-1/8" - 1.5", BB 386mm, powermeter compatible, internal cable routing, EC/DC compatible.
<b>Fork</b>	Orca Aero OMR carbon fork, full carbon steerer, tapered 1-1/8" - 1.5", carbon dropouts
<b>Crankset</b>	SRAM Red 34x50t Rotor 2INpower DM 34x50t Rotor 2INpower DM 36x52t SRAM Red 39x53t
<b>Headset</b>	FSA 1-1/8 - 1-1/2" Integrated Carbon Cup ACB Bearings
<b>Handlebar</b>	Vision Metron 5D Compact Vision Metron 4D Compact + Orbea OC III Stem



<b>Handlebar Plugs</b>	Black Anti-Slippery/Shock Proof Bar Tape
<b>Stem</b>	FSA Metron 5D Compact Handlebar integrated
<b>Shifters</b>	SRAM Red eTAP
<b>Brakes</b>	SRAM S900
<b>Rear Derailleur</b>	SRAM Red eTAP
<b>Front Derailleur</b>	SRAM Red eTAP
<b>Chain</b>	SRAM Red 22 11-Speed
<b>Wheels</b>	DT ARC 1400 Dicut 48 Carbon TL Fulcrum Racing Quattro Carbon DT Swiss PR1600 Spline 32
<b>Cassette</b>	SRAM Red XG-1190 11-28t 11-Speed SRAM Red XG-1190 11-25t 11-Speed

<b>Tyres</b>	Hutchinson Fusion 5 All Season TLR 700x25 Hutchinson Fusion 5 All Season TLR 700x28
<b>Pedals</b>	N/A
<b>Seatpost</b>	Orbea Aero OMR
<b>Saddle</b>	Prologo Dimension T4,0 size 143 mm Prologo Scratch-2 Tirox size 143 mm Black Selle Italia SLR Kit Carbonio Black

# ORCA AERO M101 TEAM

Code	J150		
Size	Crank	Stem	Handlebar
47	170	100	400
49	170	100	400
51	170	100	420
53	170	110	420
55	172	110	420
57	172	120	420
60	175	120	420



<b>Frame</b>	Orbea Orca Aero carbon OMR, monocoque construction, tapered 1-1/8" - 1.5", BB 386mm, powermeter compatible, internal cable routing, EC/DC compatible.
<b>Fork</b>	Orca Aero OMR carbon fork, full carbon steerer, tapered 1-1/8" - 1.5", carbon dropouts
<b>Crankset</b>	Shimano Dura-Ace 9100 34x50t Shimano Dura-Ace R9100 39x53t Rotor Aldhu 36x52t Rotor 2INpower DM 34x50t Rotor 2INpower DM 36x52t
<b>Headset</b>	FSA 1-1/8 - 1-1/2" Integrated Carbon Cup ACB Bearings
<b>Handlebar</b>	Vision Metron 5D Compact



<b>Handlebar Plugs</b>	Black Anti-Slippery/Shock Proof Bar Tape
<b>Stem</b>	FSA Metron 5D Compact Handlebar integrated
<b>Shifters</b>	Shimano Dura-Ace 9150 Di2
<b>Brakes</b>	Shimano Dura-Ace R9110
<b>Rear Derailleur</b>	Shimano Dura-Ace 9150 Di2
<b>Front Derailleur</b>	Shimano Dura-Ace 9150 Di2
<b>Chain</b>	Shimano HG901-11
<b>Wheels</b>	FULCRUM Racing Quattro Carbon DT Swiss PR1600 Spline 32 DT Swiss ARC1400 Dicut 48
<b>Cassette</b>	Shimano Dura-Ace 9100 11-28t 11-Speed

<b>Tyres</b>	Shimano Dura-Ace R9100 11-25t 11-Speed Shimano Dura-Ace R9100 11-30t 11-Speed Vittoria Open Corsa Competition G+ 700x25c Hutchinson Fusion 5 All Season TLR 700x28 Hutchinson Fusion 5 All Season TLR 700x25
<b>Pedals</b>	N/A
<b>Seatpost</b>	Orbea Aero OMR
<b>Saddle</b>	Prologo Dimension T4,0 size 143 mm Prologo Scratch-2 Tirox size 143 mm Black Selle Italia SLR Kit Carbonio Black

## ORCA AERO M12SR TEAM

Code	J152			
	Size	Crank	Stem	Handlebar
	47	170	100	400
	49	170	100	400
	51	170	100	420
	53	170	110	420
	55	172	110	420
	57	172	120	420
	60	175	120	420



<b>Frame</b>	Orbea Orca Aero carbon OMR, monocoque construction, tapered 1-1/8" - 1.5", BB 386mm, powermeter compatible, internal cable routing, EC/DC compatible.
<b>Fork</b>	Orca Aero OMR carbon fork, full carbon steerer, tapered 1-1/8" - 1.5", carbon dropouts
<b>Crankset</b>	Campagnolo Super Record 34x50t Rotor 2INpower DM 34x50t Rotor 2INpower DM 36x52t
<b>Headset</b>	FSA 1-1/8 - 1-1/2" Integrated Carbon Cup ACB Bearings
<b>Handlebar</b>	Vision Metron 5D Compact Vision Metron 4D Compact + Orbea OC III Stem
<b>Handlebar Plugs</b>	Black Anti-Slippery/Shock Proof Bar Tape

<b>Stem</b>	FSA Metron 5D Compact Handlebar integrated
<b>Shifters</b>	Campagnolo Super Record
<b>Brakes</b>	Campagnolo Direct mount
<b>Rear Derailleur</b>	Campagnolo Super Record
<b>Front Derailleur</b>	Campagnolo Super Record
<b>Chain</b>	Campagnolo Super Record-12
<b>Wheels</b>	FULCRUM Racing Quattro Carbon Fulcrum Racing 400 Clincher
<b>Cassette</b>	Campagnolo Super Record 11-29 12-Speed
<b>Tyres</b>	Vittoria Rubino Pro 700x25 120TPI G+ Hutchinson Fusion 5 All Season TLR 700x28

<b>Pedals</b>	N/A
<b>Seatpost</b>	Orbea Aero OMR
<b>Saddle</b>	Prologo Dimension T4,0 size 143 mm Black Selle Italia SLR Kit Carbonio Black

<b>Tyres</b>	Hutchinson Fusion 5 All Season TLR 700x25
--------------	---

## ORCA AERO M10 TEAM

Code	J149			
	Size	Crank	Stem	Handlebar
	47	170	90	400
	49	170	100	400
	51	170	100	420
	53	170	110	420
	55	172	110	420
	57	172	110	440
	60	175	120	440



<b>Frame</b>	Orbea Orca Aero carbon OMR, monocoque construction, tapered 1-1/8" - 1.5", BB 386mm, powermeter compatible, internal cable routing, EC/DC compatible.
<b>Fork</b>	Orca Aero OMR carbon fork, full carbon steerer, tapered 1-1/8" - 1.5", carbon dropouts
<b>Crankset</b>	Shimano Dura-Ace 9100 34x50t Shimano Dura-Ace R9100 39x53t Rotor Aldhu 36x52t Rotor 2INpower DM 34x50t Rotor 2INpower DM 36x52t
<b>Headset</b>	FSA 1-1/8 - 1-1/2" Integrated Carbon Cup ACB Bearings
<b>Handlebar</b>	Vision Metron 4D Compact Vision Metron 5D Compact

<b>Handlebar Plugs</b>	Black Anti-Slippery/Shock Proof Bar Tape
<b>Stem</b>	Orbea OC-III
<b>Shifters</b>	Shimano Dura-Ace 9100
<b>Brakes</b>	Shimano Dura-Ace R9110
<b>Rear Derailleur</b>	Shimano Dura-Ace 9100
<b>Front Derailleur</b>	Shimano Dura-Ace 9100
<b>Chain</b>	Shimano HG901-11
<b>Wheels</b>	DT PR 1600 Spline 32 Fulcrum Racing Quattro Carbon DT Swiss ARC1400 Dicut 48
<b>Cassette</b>	Shimano Dura-Ace 9100 11-28t 11-Speed Shimano Dura-Ace R9100 11-25t 11-Speed Shimano Dura-Ace R9100 11-30t 11-Speed

<b>Tyres</b>	Hutchinson Fusion 5 All Season TLR 700x25 Hutchinson Fusion 5 All Season TLR 700x28
<b>Pedals</b>	N/A
<b>Seatpost</b>	Orbea Aero OMR
<b>Saddle</b>	Prologo Dimension T4,0 size 143 mm Black Selle Italia SLR Kit Carbonio Black

## ORCA AERO M12 TEAM

Code	J148			
	Size	Crank	Stem	Handlebar
	47	170	90	400
	49	170	100	400
	51	170	100	420
	53	170	110	420
	55	172	110	420
	57	172	110	440
	60	175	120	440



<b>Frame</b>	Orbea Orca Aero carbon OMR, monocoque construction, tapered 1-1/8" - 1.5", BB 386mm, powermeter compatible, internal cable routing, EC/DC compatible.
<b>Fork</b>	Orca Aero OMR carbon fork, full carbon steerer, tapered 1-1/8" - 1.5", carbon dropouts
<b>Crankset</b>	Campagnolo Record 34x50t 12-Speed Rotor 2INpower DM 34x50t Rotor 2INpower DM 36x52t
<b>Headset</b>	FSA 1-1/8 - 1-1/2" Integrated Carbon Cup ACB Bearings
<b>Handlebar</b>	FSA Trimax Compact Vision Metron 5D Compact Vision Metron 4D Compact

<b>Handlebar Plugs</b>	Black Anti-Slippery/Shock Proof Bar Tape
<b>Stem</b>	Orbea OC-III
<b>Shifters</b>	Campagnolo Record
<b>Brakes</b>	Campagnolo Direct mount
<b>Rear Derailleur</b>	Campagnolo Record 12-speed
<b>Front Derailleur</b>	Campagnolo Record
<b>Chain</b>	Campagnolo Super Record-12
<b>Wheels</b>	FULCRUM Racing 400 Fulcrum Racing Quattro Carbon
<b>Cassette</b>	Campagnolo Super Record 11-29 12-Speed
<b>Tyres</b>	Vittoria Rubino Pro 700x25 120TPI G+ Hutchinson Fusion 5 All Season TLR 700x28

<b>Pedals</b>	N/A
<b>Seatpost</b>	Orbea Aero OMR
<b>Saddle</b>	Prologo Dimension T4,0 size 143 mm Black Selle Italia SLR Kit Carbonio Black

<b>Tyres</b>	Hutchinson Fusion 5 All Season TLR 700x25
--------------	---

## ORCA AERO M20I TEAM

Code	J147			
	Size	Crank	Stem	Handlebar
	47	170	90	400
	49	170	100	400
	51	170	100	420
	53	170	110	420
	55	172	110	420
	57	172	110	440
	60	175	120	440



<b>Frame</b>	Orbea Orca Aero carbon OMR, monocoque construction, tapered 1-1/8" - 1.5", BB 386mm, powermeter compatible, internal cable routing, EC/DC compatible.
<b>Fork</b>	Orca Aero OMR carbon fork, full carbon steerer, tapered 1-1/8" - 1.5", carbon dropouts
<b>Crankset</b>	Shimano Ultegra R8000 34x50t Rotor Aldhu 36x52t Rotor 2INpower DM 34x50t Rotor 2INpower DM 36x52t Shimano Ultegra R8000 39x53t
<b>Headset</b>	FSA 1-1/8 - 1-1/2" Integrated Carbon Cup ACB Bearings
<b>Handlebar</b>	FSA Trimax Compact Vision Metron 5D Compact

<b>Handlebar Plugs</b>	Black Anti-Slippery/Shock Proof Bar Tape
<b>Stem</b>	Orbea OC-III
<b>Shifters</b>	Shimano Ultegra R8050 Di2
<b>Brakes</b>	Shimano Ultegra R8010
<b>Rear Derailleur</b>	Shimano Ultegra Di2 R8050 SS
<b>Front Derailleur</b>	Shimano Ultegra Di2 R8050
<b>Chain</b>	KMC X11-EL
<b>Wheels</b>	FULCRUM Racing 400 Fulcrum Racing Quattro Carbon DT Swiss PR1600 Spline 32
<b>Cassette</b>	Shimano Ultegra R8000 11-28t 11-Speed

<b>Tyres</b>	Shimano Ultegra R8000 11-25t 11-Speed Shimano Ultegra R8000 11-30t 11-Speed Vittoria Rubino Foldable 700x25 60TPI G+ Hutchinson Fusion 5 All Season TLR 700x28 Hutchinson Fusion 5 All Season TLR 700x25
<b>Pedals</b>	N/A
<b>Seatpost</b>	Orbea Aero OMR
<b>Saddle</b>	Prologo Dimension T4,0 size 143 mm Black Prologo Scratch-2 Tirox size 143 mm Black Selle Italia SLR Kit Carbonio Black

## ORCA AERO M20 TEAM

Code	J146		
Size	Crank	Stem	Handlebar
47	170	90	400
49	170	100	400
51	170	100	420
53	170	110	420
55	172	110	420
57	172	110	440
60	175	120	440



<b>Frame</b>	Orbea Orca Aero carbon OMR, monocoque construction, tapered 1-1/8" - 1.5", BB 386mm, powermeter compatible, internal cable routing, EC/DC compatible.
<b>Fork</b>	Orca Aero OMR carbon fork, full carbon steerer, tapered 1-1/8" - 1.5", carbon dropouts
<b>Crankset</b>	Shimano Ultegra R8000 34x50t Rotor Aldhu 36x52t Rotor 2INpower DM 34x50t Rotor 2INpower DM 36x52t Shimano Ultegra R8000 39x53t
<b>Headset</b>	FSA 1-1/8 - 1-1/2" Integrated Carbon Cup ACB Bearings
<b>Handlebar</b>	FSA Trimax Compact Vision Metron 5D Compact



<b>Handlebar Plugs</b>	Black Anti-Slippery/Shock Proof Bar Tape
<b>Stem</b>	Orbea OC-III
<b>Shifters</b>	Shimano Ultegra R8000
<b>Brakes</b>	Shimano Ultegra R8010
<b>Rear Derailleur</b>	Shimano Ultegra R8000 SS
<b>Front Derailleur</b>	Shimano Ultegra R8000
<b>Chain</b>	KMC X11-EL
<b>Wheels</b>	Vision Team 35 Comp Clincher Fulcrum Racing 400 Clincher Fulcrum Racing Quattro Carbon DT Swiss PR1600 Spline 32 DT Swiss ARC1400 Dicut 48

<b>Cassette</b>	Shimano Ultegra R8000 11-28t 11-Speed Shimano Ultegra R8000 11-25t 11-Speed Shimano Ultegra R8000 11-30t 11-Speed
<b>Tyres</b>	Vittoria Rubino Foldable 700x25 60TPI G+ Hutchinson Fusion 5 All Season TLR 700x28 Hutchinson Fusion 5 All Season TLR 700x25
<b>Pedals</b>	N/A
<b>Seatpost</b>	Orbea Aero OMR
<b>Saddle</b>	Prologo Dimension T4,0 size143 mm Prologo Scratch-2 Tirox size 143 mm Black Selle Italia SLR Kit Carbonio Black

## ORCA AERO M30 TEAM

Code	J145		
Size	Crank	Stem	Handlebar
47	170	90	400
49	170	100	400
51	170	100	420
53	170	110	420
55	172	110	420
57	172	110	440
60	175	120	440



<b>Frame</b>	Orbea Orca Aero carbon OMR, monocoque construction, tapered 1-1/8" - 1.5", BB 386mm, powermeter compatible, internal cable routing, EC/DC compatible.
<b>Fork</b>	Orca Aero OMR carbon fork, full carbon steerer, tapered 1-1/8" - 1.5", carbon dropouts
<b>Crankset</b>	Shimano 105 R7000 34x50t Rotor Aldhu 36x52t Rotor 2INpower DM 34x50t Rotor 2INpower DM 36x52t Shimano 105 R7000 39x53t
<b>Headset</b>	FSA 1-1/8 - 1-1/2" Integrated Carbon Cup ACB Bearings
<b>Handlebar</b>	FSA Trimax Compact Vision Metron 5D Compact



<b>Handlebar Plugs</b>	Black Anti-Slippery/Shock Proof Bar Tape
<b>Stem</b>	Orbea OC-III
<b>Shifters</b>	Shimano 105 R7000
<b>Brakes</b>	Shimano 105 R7010
<b>Rear Derailleur</b>	Shimano 105 R7000 SS
<b>Front Derailleur</b>	Shimano 105 R7000
<b>Chain</b>	KMC X11-EL
<b>Wheels</b>	Vision Team 35 Comp Clincher Fulcrum Racing 400 Clincher Fulcrum Racing Quattro Carbon DT Swiss PR1600 Spline 32 DT Swiss ARC1400 Dicut 48

<b>Cassette</b>	Shimano 105 R7000 11-28t 11-Speed Shimano 105 R7000 11-30t 11-Speed Shimano 105 R7000 11-32 11-Speed (RD GS)
<b>Tyres</b>	Vittoria Rubino Foldable 700x25 60TPI G+ Hutchinson Fusion 5 All Season TLR 700x28 Hutchinson Fusion 5 All Season TLR 700x25
<b>Pedals</b>	N/A
<b>Seatpost</b>	Orbea Aero OMR
<b>Saddle</b>	Prologo Dimension T4,0 size143 mm Prologo Scratch-2 Tirox size 143 mm Black Selle Italia SLR Kit Carbonio Black



## DO YOU WANT TO BE FAST?

There are plenty of great bikes that offer flexibility, a relaxed, neutral position and mellow handling. Orca is not one of them – Orca is designed for the guy who has already ridden 6000kms in February and can somehow sustain 500 watts in the middle of winter. The guy whose legs look like they are chiseled directly from the local mountains, the guy you have NEVER beaten, and is always ready to make the pace. Orca is for professionals, hardmen, hardwomen and dedicated weirdos that have never even consider quitting early. Orca is for riders who spend so much time talking about watts and training that you wouldn't dream of inviting them to your party, and they wouldn't come anyway because it's past their bedtime. Orca is misspelled – Do you want to be fast?

**ORCA**



“BIKE OF THE YEAR  
WINNER AGAIN!”  
CICLISMO A FONDO (SPAIN)

## USER

Orca is the choice of elite racers and riders who demand the most efficient bike with the best performance – athletes who are looking for leading technology, results and status. Riders who appreciate a bike that stands out. Orca riders know that a great bike will make them faster. Orca is the choice of Teams Vital and Fundación Euskadi.



## ORCA TECH



- 01 MONOCOQUE
- 02 DYNAMIC STRUCTURE
- 03 SMOOTHNESS
- 04 FREEFLOW
- 05 ORBEA ROAD RACING GEOMETRY



## MONOCOQUE

Orca uses the most technologically advanced carbon construction to make the most sophisticated frame possible – A complex and painstaking process with results you will appreciate on the road. The premier Orca OMR frame blends Toray T700, T800 and M40J fibers. Prepreg carbon sheets are laser cut to minimize excess materials and overlap, and hours of pre-molding ensure optimal compaction with the smallest amount of carbon. A full EPS (Expanded Polystyrene) mold is used to eliminate wrinkles and imperfections.

OMP  
**80G**  
 LIGHTER

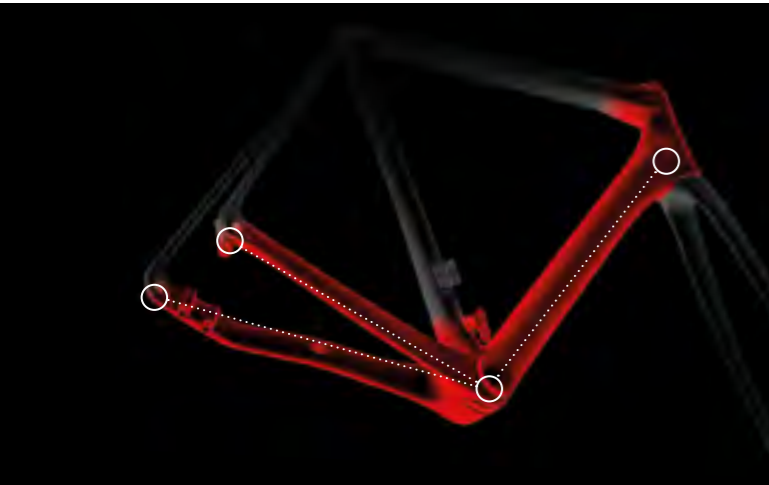

### DYNAMIC STRUCTURE

The large majority of torsional and lateral loads are handled by the lower spine of the frame. The headtube, downtube and chainstays are shaped to resist twisting and transmit power to the rear wheel. There is no doubt about it, large cross-sections and resistance to flex in the bottom of the frame translate directly to more watts on the road and a sensation that power transfer is instantaneous.

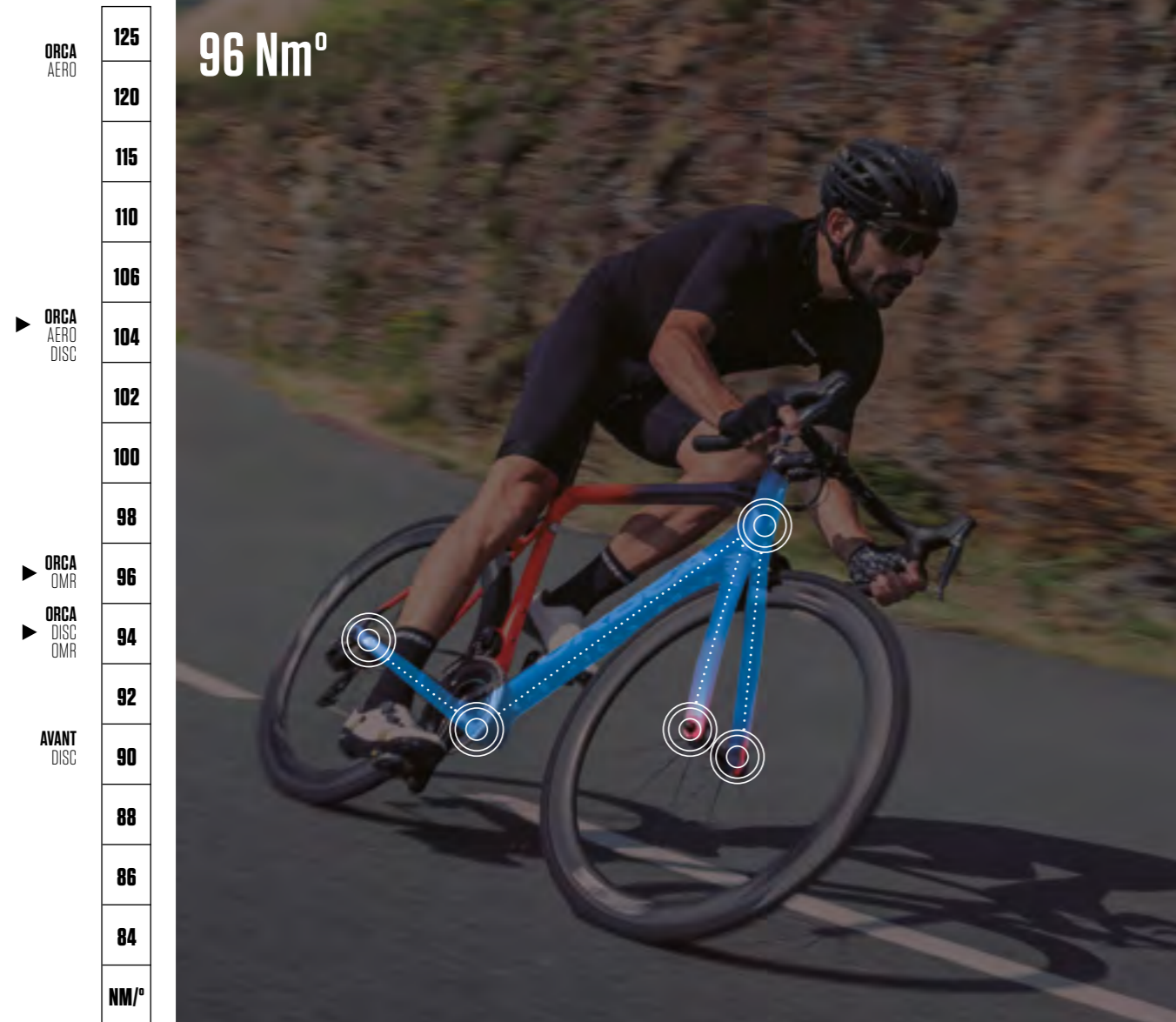

“**8.9/10**  
“RIGIDITE: CONFORT”  
LE CYCLE (FRANCE)

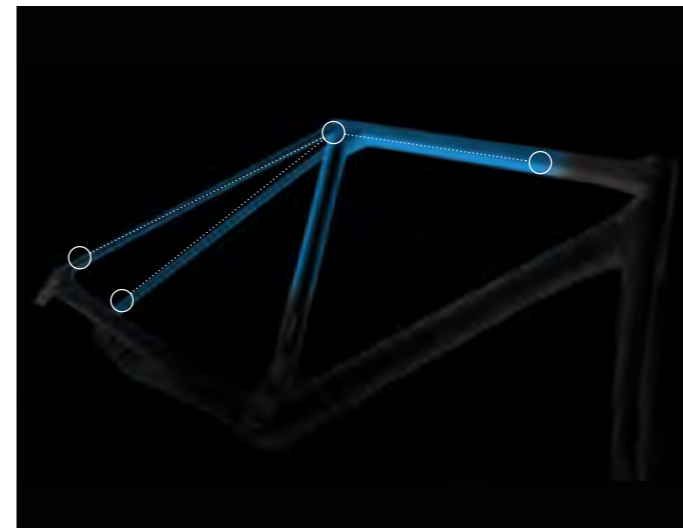

### SMOOTHNESS

External forces on the frame – cornering stresses or vibration from rough roads – have an effect on control and traction. The seat stays of the new Orca are thinner, the cross-sections and diameters reduced to give maximum traction and control over rough surfaces without compromising global rigidity. The natural flex patterns created by the carbon layup and minimal bulk of the top tube and seat stays deliver a dynamic, smooth ride that feels like floating over rough roads.

## FREEFLOW

Aerodynamic forks are typically designed to perform like aero frame tubes - optimized for directional movement through the wind. But the forward rotation of the spokes and today's wider rims and tires approaching from behind the fork (against the flow of wind as the wheel spins) creates a high pressure/high drag zone. Orca's Freeflow fork spreads the fork legs away from this area to reduce pressure and turbulence. Normal directional aerodynamics are unchanged but the bike gets faster because the airspace inside the Freeflow fork blades is less chaotic. Gains of up to 4 watts translate to .4 seconds per KM and a fork that is 10% faster than the fork of the previous Orca.

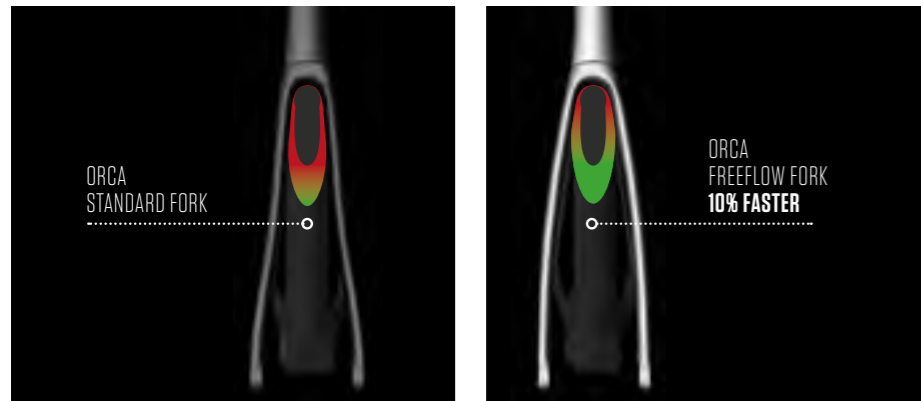

## ORBEA ROAD RACING GEOMETRY

Orca Racing Geometry is born from almost 100 years of designing road racing bikes and is the perfect balance of responsiveness and stability. The position is aggressive to maximize body aerodynamics and efficiency. Handling is precise and intuitive. Angles and dimensions are considered carefully across a range of sizes to put more power to the road with every pedal stroke, and more power means more speed. Orca is designed to fit humans of all shapes and sizes. It's important to realize that women should receive the same expert bike-fitting advice as men and a custom fit for a rider of either sex is easily accommodated with MyO component selection.

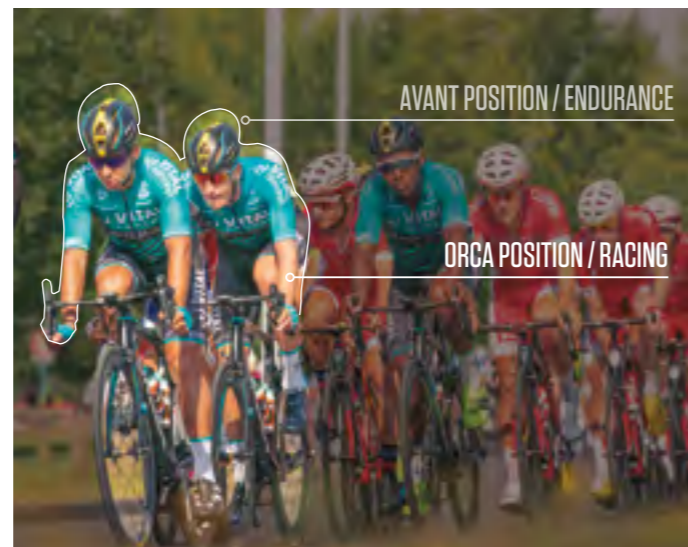

>>

MyO

# DESIGN YOUR BIKE

- 01 CHOOSE A MODEL AND SELECT OR SUBSTITUTE YOUR FAVORITE COMPONENTS.
- 02 CREATE A CUSTOM PAINT SCHEME.
- 03 ADD YOUR NAME TO THE TOPE TUBE.

WWW.ORBEA.COM



# ORCA OMR DB

SIZES	47	49	51	53	55	57	60
1 - Seat Tube (C-T)	440	460	480	500	520	540	570
2 - Top Tube (EFF)	510	522	536	548,8	560	576	590
3 - Head Tube	104	111	130	148	168	186	213
4 - Chainstay	414	414	414	414	414	414	414
5 - BB Height	269,5	269,5	269,5	271,5	271,5	271,5	271,5
6 - BB Drop	72	72	72	70	70	70	70
7 - Wheelbase	979	983	987	988	999	1009	1023
8 - Head Angle	71°	71.5°	72.2°	72.8°	73°	73.2°	73.2°
9 - Seat Angle	74.5°	74°	73.7°	73.5°	73.5°	73.2°	73.2°
10 - Standover	729	742	758	780	800	817	844
11 - Reach	370	375	380	385	391	398	404
12 - Stack	506	515	533	552	572	590	616
13 - Fork Length	370	370	370	370	370	370	370

HEIGHT (cm)	HEIGHT (in)	SIZE
155-160	61.1"-63.0"	47
160-166	63.0"-65.4"	49
167-172	65.7"-67.7"	51
173-179	68.1"-70.5"	53
180-185	70.9"-72.8"	55
186-191	73.2"-75.2"	57
192-207	75.6"-81.5"	60

-  Black-Red  
**AT**
-  Black-Red-White (Matt-Gloss)  
**AV**
-  Mint-Black (Gloss)  
**AX**
-  MyO  
**CM**
-  Black-Grey  
**AU**
-  Blue-Orange (Matt)  
**AW**
-  Yellow-Red (Gloss)  
**AY**

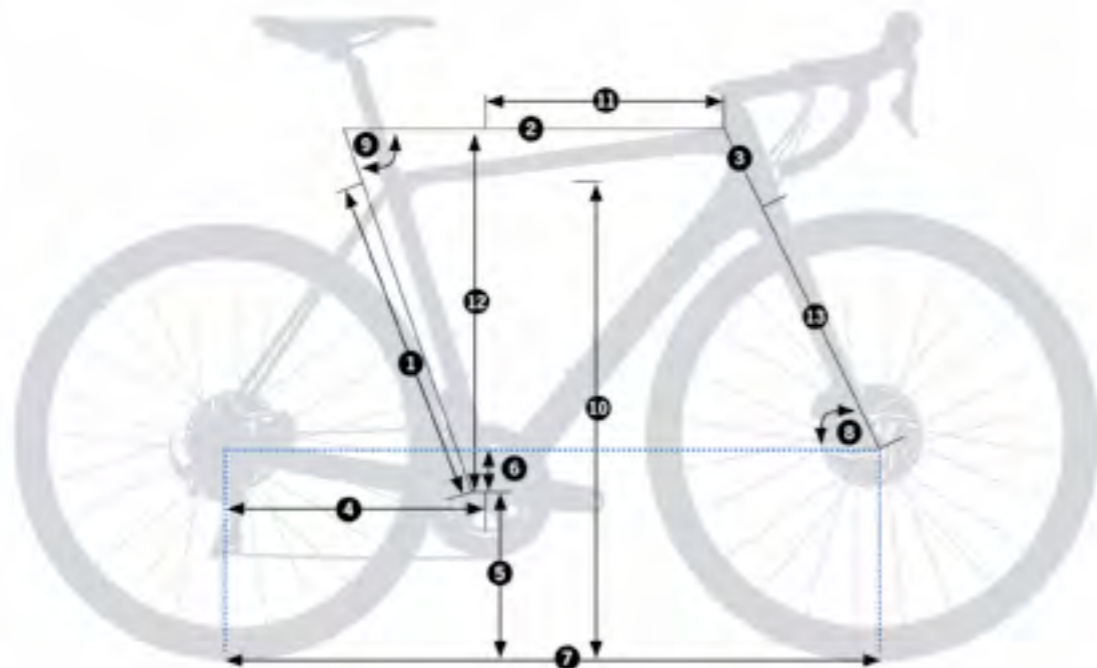

# ORCA M10I LTD-D

Code	J144		
Size	Crank	Stem	Handlebar
47	170	90	400
49	170	100	400
51	170	100	420
53	170	110	420
55	172	110	420
57	172	110	440
60	175	120	440



<b>Frame</b>	Orbea Orca carbon OMR Disc, monocoque construction, tapered 1-1/8" - 1,5", BB 386mm, powermeter compatible, Thru Axle 12mm x 142mm rear, internal cable routing, EC/DC compatible, 27,2mm seat tube.
<b>Fork</b>	Orbea Orca OMR Disc carbon fork, full carbon steerer, tapered 1-1/8" - 1,5", carbon dropouts, Thru axle 12 x 100mm.
<b>Crankset</b>	Shimano Dura-Ace 9100 34x50t Shimano Dura-Ace R9100 39x53t Rotor Aldhu 36x52t Rotor 2INpower DM 34x50t Rotor 2INpower DM 36x52t
<b>Headset</b>	FSA 1-1/8" - 1-1/2" Integrated Carbon Cup Light Bearings
<b>Handlebar</b>	FSA K-Force Compact



<b>Handlebar Plugs</b>	Black Anti-Slippery/Shock Proof Bar Tape
<b>Stem</b>	FSA OS-99 CSI FSA Energy
<b>Shifters</b>	Shimano R9170
<b>Brakes</b>	Shimano R9170 Hydraulic Disc
<b>Rear Derailleur</b>	Shimano Dura-Ace 9150 Di2
<b>Front Derailleur</b>	Shimano Dura-Ace 9150 Di2
<b>Chain</b>	Shimano HG901-11
<b>Wheels</b>	DT ARC 1400 Dicut DB 48 Carbon CL TL Fulcrum Racing Quattro Carbon DB Mavic Ksyrium Elite Black UST DB + Tires Fulcrum Racing 500 DB

<b>Cassette</b>	Shimano Dura-Ace 9100 11-28t 11-Speed Shimano Dura-Ace R9100 11-25t 11-Speed Shimano Dura-Ace R9100 11-30t 11-Speed
<b>Tyres</b>	Hutchinson Fusion 5 All Season TLR 700x25 Hutchinson Fusion 5 All Season TLR 700x28
<b>Pedals</b>	N/A
<b>Seatpost</b>	FSA K-Force Light SB25 27,2x400mm Di2 compatible FSA S-LK Offset SB0 27,2x350/400mm FSA S-LK Offset SB20 27,2x350/400mm FSA K-Force Offset SB0 27,2x350/400mm
<b>Saddle</b>	Selle Italia SLR Kit Carbonio Prologo Scratch-2 Tirox size 143 mm Black Prologo Dimension T4,0 Black

# ORCA M10 TEAM-D

Code	J143		
Size	Crank	Stem	Handlebar
47	170	90	400
49	170	100	400
51	170	100	420
53	170	110	420
55	172	110	420
57	172	110	440
60	175	120	440



<b>Frame</b>	Orbea Orca carbon OMR Disc, monocoque construction, tapered 1-1/8" - 1,5", BB 386mm, powermeter compatible, Thru Axle 12mm x 142mm rear, internal cable routing, EC/DC compatible, 27,2mm seat tube.
<b>Fork</b>	Orbea Orca OMR Disc carbon fork, full carbon steerer, tapered 1-1/8" - 1,5", carbon dropouts, Thru axle 12 x 100mm.
<b>Crankset</b>	Shimano Dura-Ace 9100 34x50t Shimano Dura-Ace R9100 39x53t Rotor Aldhu 36x52t Rotor 2INpower DM 34x50t Rotor 2INpower DM 36x52t
<b>Headset</b>	FSA 1-1/8" - 1-1/2" Integrated Carbon Cup Light Bearings
<b>Handlebar</b>	FSA Energy Compact Vision Metron 4D Compact



<b>Handlebar Plugs</b>	Black Anti-Slippery/Shock Proof Bar Tape
<b>Stem</b>	FSA OS-99 CSI FSA Energy
<b>Shifters</b>	Shimano R9120
<b>Brakes</b>	Shimano R9170 Hydraulic Disc
<b>Rear Derailleur</b>	Shimano Dura-Ace 9100
<b>Front Derailleur</b>	Shimano Dura-Ace 9100
<b>Chain</b>	Shimano HG901-11
<b>Wheels</b>	DT ER 1600 Spline DB 32 CL TL Fulcrum Racing Quattro Carbon DB DT Swiss ARC1400 Dicut 48 DB Mavic Ksyrium Elite Black UST DB + Tires
<b>Cassette</b>	Shimano Dura-Ace 9100 11-28t 11-Speed

<b>Tyres</b>	Hutchinson Fusion 5 All Season TLR 700x25 Hutchinson Fusion 5 All Season TLR 700x28
<b>Pedals</b>	N/A
<b>Seatpost</b>	FSA SL-K SB20 27,2x350mm Di2 compatible FSA S-LK Offset SB0 27,2x350/400mm FSA K-Force Offset SB0 27,2x350/400mm FSA K-Force Offset SB25 27,2x350/400mm
<b>Saddle</b>	Hard Black Scratch-2 Tirox size 143 mm Selle Italia SLR Kit Carbonio Black Prologo Dimension T4,0 Black

## ORCA M20I TEAM-D

Code	J142		
Size	Crank	Stem	Handlebar
47	170	90	400
49	170	100	400
51	170	100	420
53	170	110	420
55	172	110	420
57	172	110	440
60	175	120	440



<b>Frame</b>	Orbea Orca carbon OMR Disc, monocoque construction, tapered 1-1/8" - 1,5", BB 386mm, powermeter compatible, Thru Axle 12mm x 142mm rear, internal cable routing, EC/DC compatible, 27,2mm seat tube.
<b>Fork</b>	Orbea Orca OMR Disc carbon fork, full carbon steerer, tapered 1-1/8" - 1,5", carbon dropouts, Thru axle 12 x 100mm.
<b>Crankset</b>	Shimano Ultegra R8000 34x50t Rotor Aldhu 36x52t Rotor 2INpower DM 34x50t Rotor 2INpower DM 36x52t Shimano Ultegra R8000 39x53t
<b>Headset</b>	FSA 1-1/8" - 1-1/2" Integrated Carbon Cup Light Bearings
<b>Handlebar</b>	FSA Energy Compact Vision Metron 4D Compact

<b>Handlebar Plugs</b>	FSA K-Force Compact Black Anti-Slippery/Shock Proof Bar Tape
<b>Stem</b>	FSA Energy FSA OS-99 CSI
<b>Shifters</b>	Shimano ST-8070
<b>Brakes</b>	Shimano R8070 Hydraulic Disc
<b>Rear Derailleur</b>	Shimano Ultegra Di2 R8050 SS
<b>Front Derailleur</b>	Shimano Ultegra Di2 R8050
<b>Chain</b>	Shimano HG701
<b>Wheels</b>	FULCRUM Racing 500 DB Fulcrum Racing Quattro Carbon DB DT Swiss ER1600 Spline 32 DT Swiss ARC1400 Dicut 48 DB
<b>Cassette</b>	Mavic Ksyrium Elite Black UST DB + Tires Shimano Ultegra R8000 11-28t 11-Speed

<b>Tyres</b>	Shimano Ultegra R8000 11-25t 11-Speed Shimano Ultegra R8000 11-30t 11-Speed Vittoria Open Corsa Competition G+ 700x25c Hutchinson Fusion 5 All Season TLR 700x28 Hutchinson Fusion 5 All Season TLR 700x25
<b>Pedals</b>	N/A
<b>Seatpost</b>	FSA SL-K SB20 27,2x350mm Di2 compatible FSA S-LK Offset SB0 27,2x350/400mm FSA K-Force Offset SB0 27,2x350/400mm FSA K-Force Offset SB25 27,2x350/400mm
<b>Saddle</b>	Hard Black Scratch-2 Tirox size 143 mm Selle Italia SLR Kit Carbonio Black Prologo Dimension T4,0 Black

## ORCA M20 TEAM-D

Code	J141		
Size	Crank	Stem	Handlebar
47	170	90	400
49	170	100	400
51	170	100	420
53	170	110	420
55	172	110	420
57	172	110	440
60	175	120	440



<b>Frame</b>	Orbea Orca carbon OMR Disc, monocoque construction, tapered 1-1/8" - 1,5", BB 386mm, powermeter compatible, Thru Axle 12mm x 142mm rear, internal cable routing, EC/DC compatible, 27,2mm seat tube.
<b>Fork</b>	Orbea Orca OMR Disc carbon fork, full carbon steerer, tapered 1-1/8" - 1,5", carbon dropouts, Thru axle 12 x 100mm.
<b>Crankset</b>	Shimano Ultegra R8000 34x50t Rotor Aldhu 36x52t Rotor 2INpower DM 34x50t Rotor 2INpower DM 36x52t Shimano Ultegra R8000 39x53t
<b>Headset</b>	FSA 1-1/8" - 1-1/2" Integrated Carbon Cup Light Bearings
<b>Handlebar</b>	FSA Energy Compact Vision Metron 4D Compact

<b>Handlebar Plugs</b>	FSA K-Force Compact Black Anti-Slippery/Shock Proof Bar Tape
<b>Stem</b>	FSA Energy FSA OS-99 CSI
<b>Shifters</b>	Shimano ST-8020
<b>Brakes</b>	Shimano R8070 Hydraulic Disc
<b>Rear Derailleur</b>	Shimano Ultegra R8000 SS
<b>Front Derailleur</b>	Shimano Ultegra R8000
<b>Chain</b>	Shimano HG701
<b>Wheels</b>	FULCRUM Racing 500 DB Fulcrum Racing Quattro Carbon DB DT Swiss ER1600 Spline 32 DT Swiss ARC1400 Dicut 48 DB
<b>Cassette</b>	Mavic Ksyrium Elite Black UST DB + Tires Shimano Ultegra R8000 11-28t 11-Speed

<b>Tyres</b>	Shimano Ultegra R8000 11-25t 11-Speed Shimano Ultegra R8000 11-30t 11-Speed Vittoria Open Corsa Competition G+ 700x25c Hutchinson Fusion 5 All Season TLR 700x28 Hutchinson Fusion 5 All Season TLR 700x25
<b>Pedals</b>	N/A
<b>Seatpost</b>	FSA SL-K SB20 27,2x350mm Di2 compatible FSA S-LK Offset SB0 27,2x350/400mm FSA K-Force Offset SB0 27,2x350/400mm FSA K-Force Offset SB25 27,2x350/400mm
<b>Saddle</b>	Hard Black Scratch-2 Tirox size 143 mm Selle Italia SLR Kit Carbonio Black Prologo Dimension T4,0 Black

## ORCA OMR

SIZES	47	49	51	53	55	57	60
1 - Seat Tube (C-T)	440	460	480	500	520	540	570
2 - Top Tube (EFF)	510	522	536	548,5	560	576	590
3 - Head Tube	104	111	130	148	168	186	213
4 - Chainstay	408	408	408	408	408	408	408
5 - BB Height	269,5	269,5	269,5	271,5	271,5	271,5	271,5
6 - BB Drop	72	72	72	70	70	70	70
7 - Wheelbase	972	975	980	981	991	1002	1027
8 - Head Angle	71°	71.5°	72.2°	72.8°	73°	73.2°	73.2°
9 - Seat Angle	74.5°	74°	73.7°	73.5°	73.5°	73.2°	73.2°
10 - Standover	729	742	758	780	800	817	844
11 - Reach	370	375	380	385	391	398	404
12 - Stack	506	515	533	552	572	590	616
13 - Fork Length	370	370	370	370	370	370	370

HEIGHT (cm)	HEIGHT (in)	SIZE
155-160	61.1"-63.0"	47
160-166	63.0"-65.4"	49
167-172	65.7"-67.7"	51
173-179	68.1"-70.5"	53
180-185	70.9"-72.8"	55
186-191	73.2"-75.2"	57
192-207	75.6"-81.5"	60

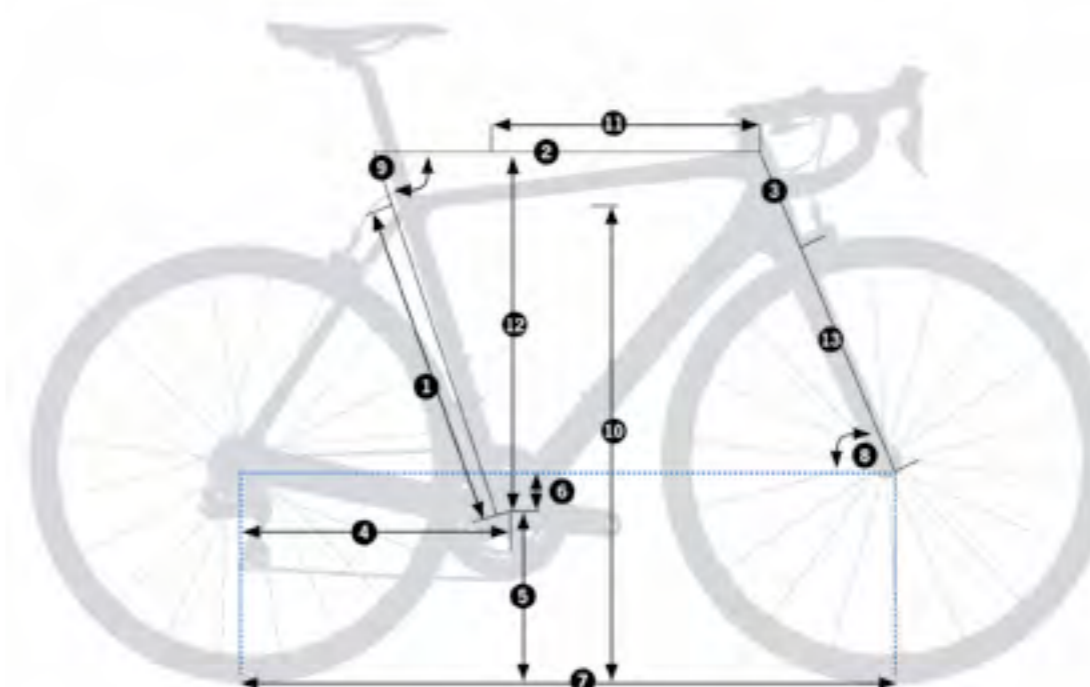

## ORCA M10I LTD



Code	J139		
Size	Crank	Stem	Handlebar
47	170	90	400
49	170	100	400
51	170	100	420
53	170	110	420
55	172	110	420
57	172	110	440
60	175	120	440



<b>Frame</b>	Orbea Orca carbon OMR, monocoque construction, tapered 1-1/8" - 1.5", BB 386mm, powermeter compatible, internal cable routing, EC/DC compatible, 27,2mm seat tube.
<b>Fork</b>	Orca OMR carbon fork, full carbon steerer, tapered 1-1/8" - 1.5", carbon dropouts.
<b>Crankset</b>	Shimano Dura-Ace 9100 34x50t Shimano Dura-Ace R9100 39x53t Rotor Aldhu 36x52t Rotor 21Npower DM 34x50t Rotor 21Npower DM 36x52t
<b>Headset</b>	FSA 1-1/8" - 1-1/2" Integrated Carbon Cup Light Bearings
<b>Handlebar</b>	Vision Metron 4D Compact FSA Energy Compact

<b>Handlebar Plugs</b>	Black Anti-Slippery/Shock Proof Bar Tape
<b>Stem</b>	FSA OS-99 CSI FSA Energy
<b>Shifters</b>	Shimano Dura-Ace 9150 Di2
<b>Brakes</b>	Shimano Dura-Ace 9100
<b>Rear Derailleur</b>	Shimano Dura-Ace 9150 Di2
<b>Front Derailleur</b>	Shimano Dura-Ace 9150 Di2
<b>Chain</b>	Shimano HG901-11
<b>Wheels</b>	DT ARC 1400 Dicut 48 Carbon TL Fulcrum Racing Quattro Carbon DT Swiss PR1600 Spline 32
	Mavic Ksyrium Elite Black UST + Tires Vittoria Elusion Carbon 30

<b>Cassette</b>	Shimano Dura-Ace 9100 11-28t 11-Speed Shimano Dura-Ace R9100 11-25t 11-Speed Shimano Dura-Ace R9100 11-30t 11-Speed
<b>Tyres</b>	Hutchinson Fusion 5 All Season TLR 700x25 Hutchinson Fusion 5 All Season TLR 700x28
<b>Pedals</b>	N/A
<b>Seatpost</b>	FSA K-Force Light SB25 27,2x400mm Di2 compatible FSA S-LK Offset SB0 27,2x350/400mm FSA S-LK Offset SB20 27,2x350/400mm FSA K-Force Offset SB0 27,2x350/400mm
<b>Saddle</b>	Selle Italia SLR Kit Carbonio Prologo Scratch-2 Tirox size 143 mm Black Prologo Dimension T4,0 Black

## ORCA M12 SRLTD



Code	J140		
Size	Crank	Stem	Handlebar
47	170	90	400
49	170	100	400
51	170	100	420
53	170	110	420
55	172	110	420
57	172	110	440
60	175	120	440



<b>Frame</b>	Orbea Orca carbon OMR, monocoque construction, tapered 1-1/8" - 1.5", BB 386mm, powermeter compatible, internal cable routing, EC/DC compatible, 27,2mm seat tube.
<b>Fork</b>	Orca OMR carbon fork, full carbon steerer, tapered 1-1/8" - 1.5", carbon dropouts.
<b>Crankset</b>	Campagnolo Super Record 34x50t Rotor 21Npower DM 34x50t Rotor 21Npower DM 36x52t
<b>Headset</b>	FSA 1-1/8" - 1-1/2" Integrated Carbon Cup Light Bearings
<b>Handlebar</b>	Vision Metron 4D Compact FSA Energy Compact FSA K-Force Compact

<b>Handlebar Plugs</b>	Black Anti-Slippery/Shock Proof Bar Tape
<b>Stem</b>	FSA OS-99 CSI FSA Energy
<b>Shifters</b>	Campagnolo Super Record
<b>Brakes</b>	Campagnolo Super Record
<b>Rear Derailleur</b>	Campagnolo Super Record
<b>Front Derailleur</b>	Campagnolo Super Record
<b>Chain</b>	Campagnolo Super Record-12
<b>Wheels</b>	FULCRUM Racing Quattro Carbon Fulcrum Racing 400 Clincher
<b>Cassette</b>	Campagnolo Super Record 11-29 12-Speed
<b>Tyres</b>	Vittoria Rubino Pro 700x25 120TPI G+

<b>Pedals</b>	N/A
<b>Seatpost</b>	FSA K-Force Light SB25 27,2x400mm Di2 compatible FSA S-LK Offset SB0 27,2x350/400mm FSA S-LK Offset SB20 27,2x350/400mm FSA K-Force Offset SB0 27,2x350/400mm
<b>Saddle</b>	Hard Black Scratch-2 Tirox size 143 mm Selle Italia SLR Kit Carbonio Black Prologo Dimension T4,0 Black

## ORCA M10 LTD



Code	J138		
Size	Crank	Stem	Handlebar
47	170	90	400
49	170	100	400
51	170	100	420
53	170	110	420
55	172	110	420
57	172	110	440
60	175	120	440



<b>Frame</b>	Orbea Orca carbon OMR, monocoque construction, tapered 1-1/8" - 1.5", BB 386mm, powermeter compatible, internal cable routing, EC/DC compatible, 27,2mm seat tube.
<b>Fork</b>	Orca OMR carbon fork, full carbon steerer, tapered 1-1/8" - 1.5", carbon dropouts.
<b>Crankset</b>	Shimano Dura-Ace 9100 34x50t Shimano Dura-Ace R9100 39x53t Rotor Aldhu 36x52t Rotor 21Npower DM 34x50t Rotor 21Npower DM 36x52t
<b>Headset</b>	FSA 1-1/8" - 1-1/2" Integrated Carbon Cup Light Bearings
<b>Handlebar</b>	Vision Metron 4D Compact FSA Energy Compact FSA K-Force Compact

<b>Handlebar Plugs</b>	Black Anti-Slippery/Shock Proof Bar Tape
<b>Stem</b>	FSA OS-99 CSI FSA Energy
<b>Shifters</b>	Shimano Dura-Ace 9100
<b>Brakes</b>	Shimano Dura-Ace 9100
<b>Rear Derailleur</b>	Shimano Dura-Ace 9100
<b>Front Derailleur</b>	Shimano Dura-Ace 9100
<b>Chain</b>	Shimano HG901-11
<b>Wheels</b>	FULCRUM Racing Quattro Carbon DT Swiss PR1600 Spline 32 DT Swiss ARC1400 Dicut 48
	Mavic Ksyrium Elite Black UST + Tires Vittoria Elusion Carbon 30
<b>Cassette</b>	Shimano Dura-Ace 9100 11-28t 11-Speed

	Shimano Dura-Ace R9100 11-25t 11-Speed Shimano Dura-Ace R9100 11-30t 11-Speed
<b>Tyres</b>	Vittoria Open Corsa Competition G+ 700x25c Hutchinson Fusion 5 All Season TLR 700x28 Hutchinson Fusion 5 All Season TLR 700x25
<b>Pedals</b>	N/A
<b>Seatpost</b>	FSA K-Force Light SB25 27,2x400mm Di2 compatible FSA S-LK Offset SB0 27,2x350/400mm FSA S-LK Offset SB20 27,2x350/400mm FSA K-Force Offset SB0 27,2x350/400mm
<b>Saddle</b>	Hard Black Scratch-2 Tirox size 143 mm Selle Italia SLR Kit Carbonio Black Prologo Dimension T4,0 Black

## ORCA M20I TEAM



Code	J137		
Size	Crank	Stem	Handlebar
47	170	90	400
49	170	100	400
51	170	100	420
53	170	110	420
55	172	110	420
57	172	110	440
60	175	120	440



<b>Frame</b>	Orbea Orca carbon OMR, monocoque construction, tapered 1-1/8" - 1.5", BB 386mm, powermeter compatible, internal cable routing, EC/DC compatible, 27,2mm seat tube.
<b>Fork</b>	Orca OMR carbon fork, full carbon steerer, tapered 1-1/8" - 1.5", carbon dropouts.
<b>Crankset</b>	Shimano Ultegra R8000 34x50t Rotor Aldhu 36x52t Rotor 21Npower DM 34x50t Rotor 21Npower DM 36x52t Shimano Ultegra R8000 39x53t
<b>Headset</b>	FSA 1-1/8" - 1-1/2" Integrated Carbon Cup Light Bearings
<b>Handlebar</b>	FSA Energy Compact Vision Metron 4D Compact FSA K-Force Compact

<b>Handlebar Plugs</b>	Black Anti-Slippery/Shock Proof Bar Tape
<b>Stem</b>	FSA Energy FSA OS-99 CSI
<b>Shifters</b>	Shimano Ultegra R8050 Di2
<b>Brakes</b>	Shimano Ultegra R8000
<b>Rear Derailleur</b>	Shimano Ultegra Di2 R8050 SS
<b>Front Derailleur</b>	Shimano Ultegra Di2 R8050
<b>Chain</b>	Shimano HG701
<b>Wheels</b>	Mavic Ksyrium UST Clincher Fulcrum Racing Quattro Carbon DT Swiss PR1600 Spline 32 DT Swiss ARC1400 Dicut 48
	Mavic Ksyrium Elite Black UST + Tires Vittoria Elusion Carbon 30
<b>Cassette</b>	Shimano Ultegra R8000 11-28t 11-Speed

	Shimano Ultegra R8000 11-25t 11-Speed Shimano Ultegra R8000 11-30t 11-Speed
<b>Tyres</b>	Vittoria Open Corsa Competition G+ 700x25c Hutchinson Fusion 5 All Season TLR 700x28 Hutchinson Fusion 5 All Season TLR 700x25
<b>Pedals</b>	N/A
<b>Seatpost</b>	FSA S-LK SB20 27,2x350mm Di2 compatible FSA S-LK Offset SB0 27,2x350/400mm FSA K-Force Offset SB0 27,2x350/400mm FSA K-Force Offset SB25 27,2x350/400mm
<b>Saddle</b>	Hard Black Scratch-2 Tirox size 143 mm Selle Italia SLR Kit Carbonio Black Prologo Dimension T4,0 Black

# ORCA M20 TEAM



Code	J136		
Size	Crank	Stem	Handlebar
47	170	90	400
49	170	100	400
51	170	100	420
53	170	110	420
55	172	110	420
57	172	110	440
60	175	120	440



<b>Frame</b>	Orbea Orca carbon OMR, monocoque construction, tapered 1-1/8" - 1.5", BB 386mm, powermeter compatible, internal cable routing, EC/DC compatible, 27,2mm seat tube.
<b>Fork</b>	Orca OMR carbon fork, full carbon steerer, tapered 1-1/8" - 1.5", carbon dropouts.
<b>Crankset</b>	Shimano Ultegra R8000 34x50t Rotor Aldhu 36x52t Rotor 2INpower DM 34x50t Rotor 2INpower DM 36x52t Shimano Ultegra R8000 39x53t
<b>Headset</b>	FSA 1-1/8" - 1-1/2" Integrated Carbon Cup Light Bearings
<b>Handlebar</b>	FSA Energy Compact Vision Metron 4D Compact FSA K-Force Compact

<b>Handlebar Plugs</b>	Black Anti-Slippery/Shock Proof Bar Tape
<b>Stem</b>	FSA Energy FSA OS-99 CSI
<b>Shifters</b>	Shimano Ultegra R8000
<b>Brakes</b>	Shimano Ultegra R8000
<b>Rear Derailleur</b>	Shimano Ultegra R8000 SS
<b>Front Derailleur</b>	Shimano Ultegra R8000
<b>Chain</b>	Shimano HG701
<b>Wheels</b>	Mavic Ksyrium UST Clincher Fulcrum Racing Quattro Carbon DT Swiss PR1600 Spline 32 DT Swiss ARC1400 Dicut 48 Mavic Ksyrium Elite Black UST + Tires Vittoria Elusion Carbon 30
<b>Cassette</b>	Shimano Ultegra R8000 11-28t 11-Speed



<b>Tyres</b>	Vittoria Open Corsa Competition G+ 700x25c Hutchinson Fusion 5 All Season TLR 700x28 Hutchinson Fusion 5 All Season TLR 700x25
<b>Pedals</b>	N/A
<b>Seatpost</b>	FSA SL-K SB20 27,2x350/400mm compatible FSA S-LK Offset SB0 27,2x350/400mm FSA K-Force Offset SB0 27,2x350/400mm FSA K-Force Offset SB25 27,2x350/400mm
<b>Saddle</b>	Hard Black Scratch-2 Tirox size 143 mm Selle Italia SLR Kit Carbonio Black Prologo Dimension T4,0 Black

# ORCA OMP PRO

SIZES	47	49	51	53	55	57	60
1 - Seat Tube (C-T)	410	440	470	490	510	530	560
2 - Top Tube (EFF)	514.8	520.55	537.9	548.5	563.7	576	590
3 - Head Tube	104	112	130	145	165	182	207.1
4 - Chainstay	405	405	405	405	408	408	408
5 - BB Height	271.5	271.5	271.5	271.5	271.5	271.5	271.5
6 - BB Drop	70	70	70	70	70	70	70
7 - Wheelbase	969.6	976.58	986.92	984.77	996.32	1003.89	1012.53
8 - Head Angle	71°	71.4°	71.8°	72.1°	72.5°	73°	73.5°
9 - Seat Angle	73.5°	73.5°	73.5°	73.5°	73.2°	73.2°	73.2°
10 - Standover	708	726	751	771	791	807	835
11 - Reach	365	372	380	385	391	398	404
12 - Stack	506	515	533	552	572	590	616
13 - Fork Length	375	375	375	375	375	375	375

HEIGHT (cm)	HEIGHT (in)	SIZE
155-160	61.1"-63.0"	47
160-166	63.0"-65.4"	49
167-172	65.7"-67.7"	51
173-179	68.1"-70.5"	53
180-185	70.9"-72.8"	55
186-191	73.2"-75.2"	57
192-207	75.6"-81.5"	60

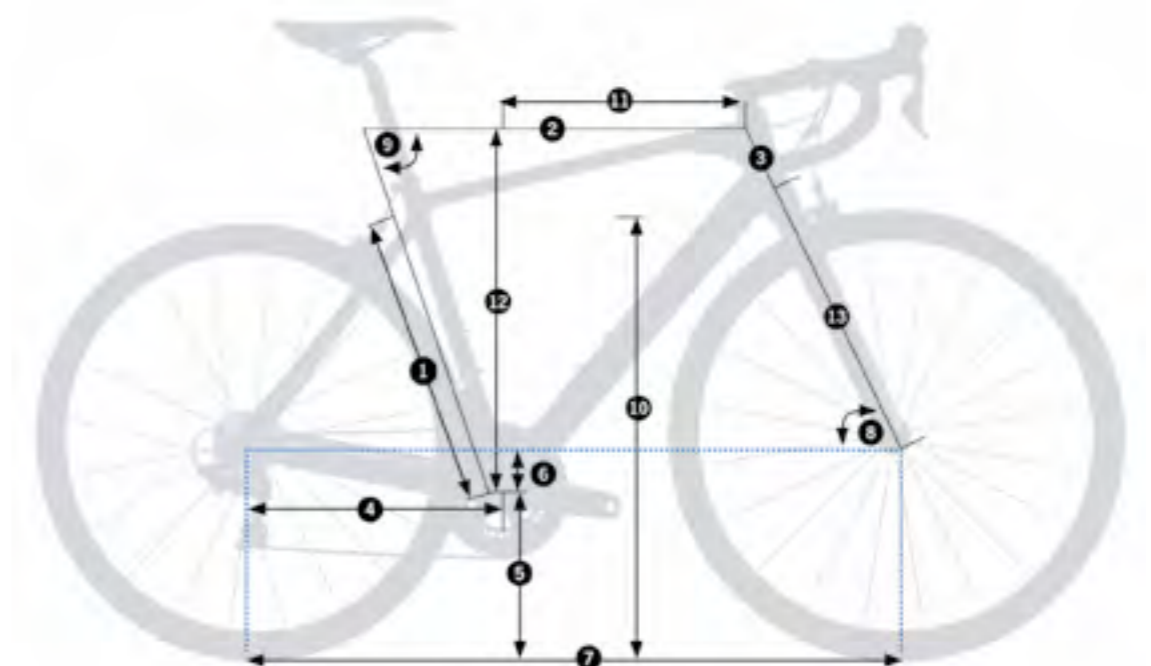
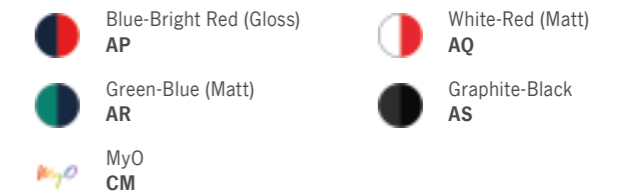

## ORCA M10 PRO



Code	J134		
Size	Crank	Stem	Handlebar
47	170	90	400
49	170	100	400
51	170	100	420
53	170	110	420
55	172	110	420
57	172	110	440
60	175	120	440



<b>Frame</b>	Orbea Orca carbon OMP, monocoque, tapered 1-1/8" - 1,5", PF 86mm, powermeter compatible, internal cable routing, EC/DC compatible, 130mm rear spacing, 27,2mm seat tube.
<b>Fork</b>	Orca OMP carbon fork, full carbon steerer, tapered 1-1/8" - 1,5", carbon dropouts.
<b>Crankset</b>	Shimano Dura-Ace 9100 34x50t Shimano Dura-Ace R9100 39x53t Rotor Aldhu 36x52t Rotor 2INpower DM 34x50t Rotor 2INpower DM 36x52t
<b>Headset</b>	FSA 1-1/8 - 1-1/2" Integrated Carbon Cup ACB Bearings
<b>Handlebar</b>	FSA Energy Compact Vision Metron 4D Compact



<b>Handlebar Plugs</b>	Black Anti-Slippery/Shock Proof Bar Tape
<b>Stem</b>	FSA Energy FSA OS-99 CSI
<b>Shifters</b>	Shimano Dura-Ace 9100
<b>Brakes</b>	Shimano Dura-Ace 9100
<b>Rear Derailleur</b>	Shimano Dura-Ace 9100
<b>Front Derailleur</b>	Shimano Dura-Ace 9100
<b>Chain</b>	Shimano HG901-11
<b>Wheels</b>	Mavic Ksyrium UST Clincher Fulcrum Racing Quattro Carbon Mavic Ksyrium Elite Black UST + Tires Vittoria Elusion Carbon 30

<b>Cassette</b>	Shimano Dura-Ace 9100 11-28t 11-Speed Shimano Dura-Ace R9100 11-25t 11-Speed Shimano Dura-Ace R9100 11-30t 11-Speed
<b>Tyres</b>	Vittoria Rubino Pro 700x25 120TPI G+
<b>Pedals</b>	N/A
<b>Seatpost</b>	FSA SL-K SB20 27,2x350mm Di2 compatible FSA S-LK Offset SB0 27,2x350/400mm FSA K-Force Offset SB0 27,2x350/400mm FSA K-Force Offset SB25 27,2x350/400mm
<b>Saddle</b>	Hard Black Scratch-2 Tirox size 143 mm Selle Italia SLR Kit Carbonio Black Prologo Dimension T4,0 Black

## ORCA M12 PRO



Code	J135		
Size	Crank	Stem	Handlebar
47	170	90	400
49	170	100	400
51	170	100	420
53	170	110	420
55	172	110	420
57	172	110	440
60	175	120	440



<b>Frame</b>	Orbea Orca carbon OMP, monocoque, tapered 1-1/8" - 1,5", PF 86mm, powermeter compatible, internal cable routing, EC/DC compatible, 130mm rear spacing, 27,2mm seat tube.
<b>Fork</b>	Orca OMP carbon fork, full carbon steerer, tapered 1-1/8" - 1,5", carbon dropouts.
<b>Crankset</b>	Campagnolo Record 34x50t 12-Speed Rotor Aldhu 36x52t Rotor 2INpower DM 34x50t Rotor 2INpower DM 36x52t
<b>Headset</b>	FSA 1-1/8 - 1-1/2" Integrated Carbon Cup ACB Bearings
<b>Handlebar</b>	FSA Energy Compact Vision Metron 4D Compact FSA K-Force Compact



<b>Handlebar Plugs</b>	Black Anti-Slippery/Shock Proof Bar Tape
<b>Stem</b>	FSA Energy FSA OS-99 CSI
<b>Shifters</b>	Campagnolo Record
<b>Brakes</b>	Campagnolo Record
<b>Rear Derailleur</b>	Campagnolo Record 12-speed
<b>Front Derailleur</b>	Campagnolo Record
<b>Chain</b>	Campagnolo Super Record-12
<b>Wheels</b>	FULCRUM Racing 400 Fulcrum Racing Quattro Carbon
<b>Cassette</b>	Campagnolo Super Record 11-29 12-Speed Campagnolo Super Record 11-32t 12-Speed

<b>Tyres</b>	Vittoria Rubino Pro 700x25 120TPI G+
<b>Pedals</b>	N/A
<b>Seatpost</b>	FSA SL-K SB20 27,2x350mm Di2 compatible FSA S-LK Offset SB0 27,2x350/400mm FSA K-Force Offset SB0 27,2x350/400mm FSA K-Force Offset SB25 27,2x350/400mm
<b>Saddle</b>	Hard Black Scratch-2 Tirox size 143 mm Selle Italia SLR Kit Carbonio Black Prologo Dimension T4,0 Black

## ORCA M20I PRO



Code	J133		
Size	Crank	Stem	Handlebar
47	170	90	400
49	170	100	400
51	170	100	420
53	170	110	420
55	172	110	420
57	172	110	440
60	175	120	440



<b>Frame</b>	Orbea Orca carbon OMP, monocoque, tapered 1-1/8" - 1,5", PF 86mm, powermeter compatible, internal cable routing, EC/DC compatible, 130mm rear spacing, 27,2mm seat tube.
<b>Fork</b>	Orca OMP carbon fork, full carbon steerer, tapered 1-1/8" - 1,5", carbon dropouts.
<b>Crankset</b>	Shimano Ultegra R8000 34x50t Rotor Aldhu 36x52t Rotor 2INpower DM 34x50t Rotor 2INpower DM 36x52t Shimano Ultegra R8000 39x53t FSA Gossamer Pro 32x48t
<b>Headset</b>	FSA 1-1/8 - 1-1/2" Integrated Carbon Cup ACB Bearings
<b>Handlebar</b>	FSA Energy Compact Vision Metron 4D Compact



<b>Handlebar Plugs</b>	Black Anti-Slippery/Shock Proof Bar Tape
<b>Stem</b>	FSA Energy FSA OS-99 CSI
<b>Shifters</b>	Shimano Ultegra R8050 Di2
<b>Brakes</b>	Shimano Ultegra R8000
<b>Rear Derailleur</b>	Shimano Ultegra Di2 R8050 SS Shimano Ultegra RD-R8050 GS
<b>Front Derailleur</b>	Shimano Ultegra Di2 R8050
<b>Chain</b>	KMC X11-EL
<b>Wheels</b>	Mavic Ksyrium UST Clincher Fulcrum Racing 400 Clincher Fulcrum Racing Quattro Carbon Mavic Ksyrium Elite Black UST + Tires Vittoria Elusion Carbon 30

<b>Cassette</b>	Shimano Ultegra R8000 11-28t 11-Speed Shimano Ultegra R8000 11-25t 11-Speed Shimano Ultegra R8000 11-30t 11-Speed Shimano Ultegra R8000 11-32t 11-Speed (RD GS)
<b>Tyres</b>	Vittoria Rubino Pro 700x25 120TPI G+
<b>Pedals</b>	N/A
<b>Seatpost</b>	FSA SL-K SB20 27,2x350mm Di2 compatible FSA S-LK Offset SB0 27,2x350/400mm FSA K-Force Offset SB0 27,2x350/400mm FSA K-Force Offset SB25 27,2x350/400mm
<b>Saddle</b>	Hard Black Scratch-2 Tirox size 143 mm Selle Italia SLR Kit Carbonio Black Prologo Dimension T4,0 Black

## ORCA M25 PRO



Code	J132		
Size	Crank	Stem	Handlebar
47	170	90	400
49	170	100	400
51	170	100	420
53	170	110	420
55	172	110	420
57	172	110	440
60	175	120	440



<b>Frame</b>	Orbea Orca carbon OMP, monocoque, tapered 1-1/8" - 1,5", PF 86mm, powermeter compatible, internal cable routing, EC/DC compatible, 130mm rear spacing, 27,2mm seat tube.
<b>Fork</b>	Orca OMP carbon fork, full carbon steerer, tapered 1-1/8" - 1,5", carbon dropouts.
<b>Crankset</b>	Shimano Ultegra R8000 34x50t Rotor Aldhu 36x52t Rotor 2INpower DM 34x50t Rotor 2INpower DM 36x52t Shimano Ultegra R8000 39x53t FSA Gossamer Pro 32x48t
<b>Headset</b>	FSA 1-1/8 - 1-1/2" Integrated Carbon Cup ACB Bearings
<b>Handlebar</b>	FSA Energy Compact Vision Metron 4D Compact



<b>Handlebar Plugs</b>	Black Anti-Slippery/Shock Proof Bar Tape
<b>Stem</b>	FSA Energy FSA OS-99 CSI
<b>Shifters</b>	Shimano Ultegra R8000
<b>Brakes</b>	Shimano Ultegra R8000
<b>Rear Derailleur</b>	Shimano Ultegra R8000 SS Shimano Ultegra RD-R8000 GS
<b>Front Derailleur</b>	Shimano Ultegra R8000
<b>Chain</b>	KMC X11-EL
<b>Wheels</b>	Vittoria Elusion Carbon Clincher 30c Fulcrum Racing 400 Clincher Fulcrum Racing Quattro Carbon Mavic Ksyrium Elite Black UST + Tires
<b>Cassette</b>	Shimano Ultegra R8000 11-28t 11-Speed

<b>Tyres</b>	Vittoria Rubino Foldable 700x25 60TPI G+
<b>Pedals</b>	N/A
<b>Seatpost</b>	FSA SL-K SB20 27,2x350mm Di2 compatible FSA S-LK Offset SB0 27,2x350/400mm FSA K-Force Offset SB0 27,2x350/400mm FSA K-Force Offset SB25 27,2x350/400mm
<b>Saddle</b>	Prologo Kappa RS STN size 143mm Prologo Scratch-2 Tirox size 143 mm Black Selle Italia SLR Kit Carbonio Black Prologo Dimension T4,0 Black

## ORCA M20 PRO



Code	J131		
Size	Crank	Stem	Handlebar
47	170	90	400
49	170	100	400
51	170	100	420
53	170	110	420
55	172	110	420
57	172	110	440
60	175	120	440



<b>Frame</b>	Orbea Orca carbon OMP, monocoque, tapered 1-1/8" - 1,5", PF 86mm, powermeter compatible, internal cable routing, EC/DC compatible, 130mm rear spacing, 27,2mm seat tube.
<b>Fork</b>	Orca OMP carbon fork, full carbon steerer, tapered 1-1/8" - 1,5", carbon dropouts.
<b>Crankset</b>	Shimano Ultegra R8000 34x50t Rotor Aldhu 36x52t Rotor 21Npower DM 34x50t Rotor 21Npower DM 36x52t Shimano Ultegra R8000 39x53t FSA Gossamer Pro 32x48t
<b>Headset</b>	FSA 1-1/8 - 1-1/2" Integrated Carbon Cup ACB Bearings
<b>Handlebar</b>	FSA Energy Compact Vision Metron 4D Compact FSA K-Force Compact



<b>Handlebar Plugs</b>	Black Anti-Slippery/Shock Proof Bar Tape
<b>Stem</b>	FSA Energy FSA OS-99 CSI
<b>Shifters</b>	Shimano Ultegra R8000
<b>Brakes</b>	Shimano Ultegra R8000
<b>Rear Derailleur</b>	Shimano Ultegra R8000 SS Shimano Ultegra RD-R8000 GS
<b>Front Derailleur</b>	Shimano Ultegra R8000
<b>Chain</b>	KMC X11-EL
<b>Wheels</b>	Mavic Aksium Elite Clincher Fulcrum Racing 400 Clincher Fulcrum Racing Quattro Carbon Mavic Ksyrium Elite Black UST + Tires Vittoria Elusion Carbon 30 Mavic Ksyrium Black UST Clincher

<b>Cassette</b>	Shimano Ultegra R8000 11-28t 11-Speed Shimano Ultegra R8000 11-25t 11-Speed Shimano Ultegra R8000 11-30t 11-Speed Shimano Ultegra R8000 11-32t 11-Speed (RD GS)
<b>Tyres</b>	Vittoria Rubino Foldable 700x25 60TPI G+
<b>Pedals</b>	N/A
<b>Seatpost</b>	FSA SL-K SB20 27,2x350mm Di2 compatible FSA S-LK Offset SB0 27,2x350/400mm FSA K-Force Offset SB0 27,2x350/400mm FSA K-Force Offset SB25 27,2x350/400mm
<b>Saddle</b>	Prologo Kappa RS STN size 143mm Prologo Scratch-2 Tirox size 143 mm Black Selle Italia SLR Kit Carbonio Black Prologo Dimension T4.0 143mm Black

## ORCA M30 PRO



Code	J130		
Size	Crank	Stem	Handlebar
47	170	90	400
49	170	100	400
51	170	100	420
53	170	110	420
55	172	110	420
57	172	110	440
60	175	120	440



<b>Frame</b>	Orbea Orca carbon OMP, monocoque, tapered 1-1/8" - 1,5", PF 86mm, powermeter compatible, internal cable routing, EC/DC compatible, 130mm rear spacing, 27,2mm seat tube.
<b>Fork</b>	Orca OMP carbon fork, full carbon steerer, tapered 1-1/8" - 1,5", carbon dropouts.
<b>Crankset</b>	Shimano 105 R7000 34x50t Rotor Aldhu 36x52t Rotor 21Npower DM 34x50t Rotor 21Npower DM 36x52t Shimano 105 R7000 39x53t FSA Gossamer Pro 32x48t
<b>Headset</b>	FSA 1-1/8 - 1-1/2" Integrated Carbon Cup ACB Bearings
<b>Handlebar</b>	FSA Energy Compact Vision Metron 4D Compact FSA K-Force Compact



<b>Handlebar Plugs</b>	Black Anti-Slippery/Shock Proof Bar Tape
<b>Stem</b>	Orbea OC-III FSA OS-99 CSI
<b>Shifters</b>	Shimano 105 R7000
<b>Brakes</b>	Shimano 105 R7000
<b>Rear Derailleur</b>	Shimano 105 R7000 SS Shimano 105 R7000 GS
<b>Front Derailleur</b>	Shimano 105 R7000
<b>Chain</b>	KMC X11-EL
<b>Wheels</b>	Mavic Aksium Fulcrum Racing 400 Clincher Fulcrum Racing Quattro Carbon Mavic Ksyrium Elite Black UST + Tires Vittoria Elusion Carbon 30 Mavic Ksyrium Black UST Clincher

<b>Cassette</b>	Mavic Aksium Elite UST Clincher Shimano 105 R7000 11-28t 11-Speed Shimano 105 R7000 11-32 11-Speed (RD GS) Shimano 105 R7000 12-25t 11-Speed
<b>Tyres</b>	Vittoria Rubino Foldable 700x25 60TPI G+
<b>Pedals</b>	N/A
<b>Seatpost</b>	FSA SL-K SB20 27,2x350mm Di2 compatible FSA S-LK Offset SB0 27,2x350/400mm FSA K-Force Offset SB0 27,2x350/400mm FSA K-Force Offset SB25 27,2x350/400mm
<b>Saddle</b>	Prologo Kappa RS STN size 143mm Prologo Scratch-2 Tirox size 143 mm Black Selle Italia SLR Kit Carbonio Black Prologo Dimension T4.0 143mm Black

## ORCA OME

SIZES	47	49	51	53	55	57	60
1 - Seat Tube (C-T)	440	460	480	500	520	540	570
2 - Top Tube (EFF)	507	522	535	550	561	575	591
3 - Head Tube	110	125	140	155	175	195	220
4 - Chainstay	408	408	408	408	408	408	408
5 - BB Height	269,5	269,5	269,5	271,5	271,5	271,5	271,5
6 - BB Drop	72	72	72	70	70	70	70
7 - Wheelbase	972	977	983	983	991	1001	1015
8 - Head Angle	71°	71.5°	72°	72.8°	73°	73.2°	73.2°
9 - Seat Angle	74.5°	74°	73.7°	73.5°	73.5°	73.2°	73.2°
10 - Standover	738,5	755,59	773,35	793,2	812,79	831,48	857,84
11 - Reach	367	370	375	382	387	393	402
12 - Stack	515	530	547	564	584	603	627
13 - Fork Length	375	375	375	375	375	375	375

HEIGHT (cm)	HEIGHT (in)	SIZE
155-160	61.1"-63.0"	47
160-166	63.0"-65.4"	49
167-172	65.7"-67.7"	51
173-179	68.1"-70.5"	53
180-185	70.9"-72.8"	55
186-191	73.2"-75.2"	57
192-207	75.6"-81.5"	60

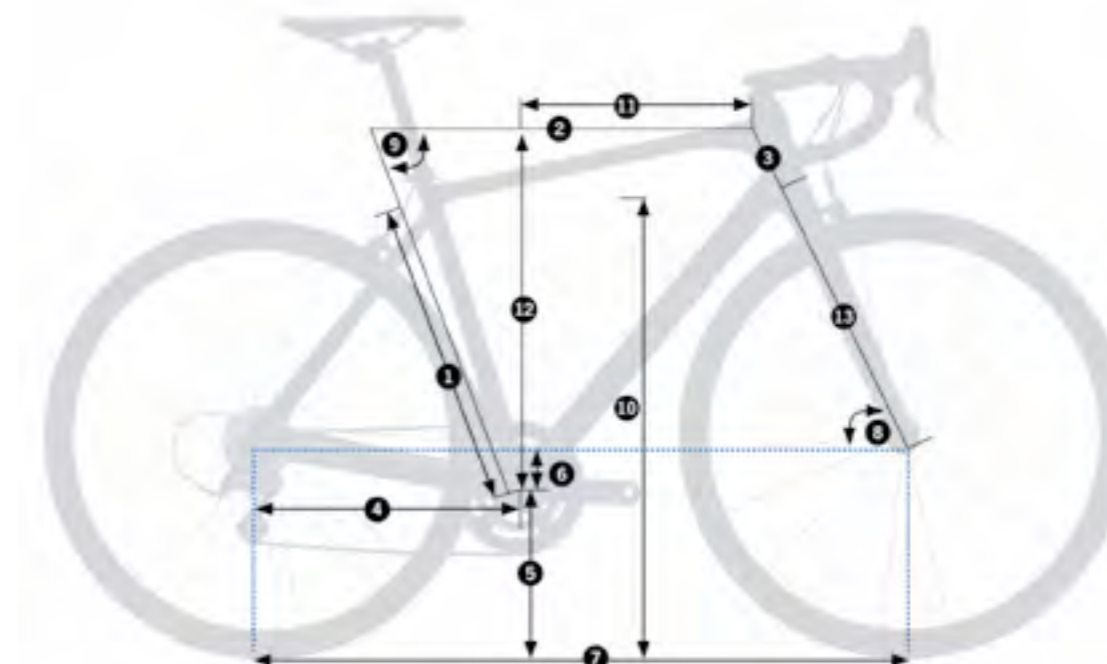
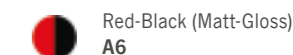
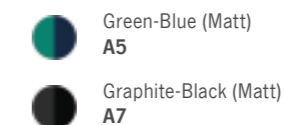

## ORCA M20I

MyOrca

Code	J129		
Size	Crank	Stem	Handlebar
47	170	90	400
49	170	100	400
51	170	100	420
53	170	110	420
55	172	110	420
57	172	110	440
60	175	120	440



<b>Frame</b>	Orbea Orca carbon OME, monocoque, tapered 1-1/8" - 1,5", PF 86mm, powermeter compatible, brake internal cable routing, EC/DC compatible, 130mm rear spacing, 27,2mm seat tube.
<b>Fork</b>	Orca OME carbon fork, full carbon steerer, tapered 1-1/8" - 1,5", carbon dropouts.
<b>Crankset</b>	Shimano Ultegra R8000 34x50t Shimano Ultegra R8000 39x53t FSA Gossamer Pro 32x48t
<b>Headset</b>	FSA 1-1/8 - 1-1/2" Integrated Aluminium Cup ACB Bearings
<b>Handlebar</b>	FSA Gossamer Compact
<b>Handlebar Plugs</b>	Bar Tape
<b>Stem</b>	Orbea OC-II

<b>Shifters</b>	Shimano Ultegra R8050 Di2
<b>Brakes</b>	Shimano Ultegra R8000
<b>Rear Derailleur</b>	Shimano Ultegra Di2 R8050 GS
<b>Front Derailleur</b>	Shimano Ultegra Di2 R8050
<b>Chain</b>	Fsa Team Issue
<b>Wheels</b>	Mavic Aksium
<b>Cassette</b>	Shimano 105 R7000 11-28t 11-Speed Shimano 105 R7000 11-30t 11-Speed Shimano 105 R7000 11-32 11-Speed (RD GS)
<b>Tyres</b>	Vittoria Rubino Foldable 700x25 60TPI G+
<b>Pedals</b>	N/A
<b>Seatpost</b>	Orbea OC-II Carbon 27.2x350mm
<b>Saddle</b>	Selle Royal Seta RS

## ORCA M20

MyOrca

Code	J128		
Size	Crank	Stem	Handlebar
47	170	90	400
49	170	100	400
51	170	100	420
53	170	110	420
55	172	110	420
57	172	110	440
60	175	120	440



<b>Frame</b>	Orbea Orca carbon OME, monocoque, tapered 1-1/8" - 1,5", PF 86mm, powermeter compatible, brake internal cable routing, EC/DC compatible, 130mm rear spacing, 27,2mm seat tube.
<b>Fork</b>	Orca OME carbon fork, full carbon steerer, tapered 1-1/8" - 1,5", carbon dropouts.
<b>Crankset</b>	Shimano Ultegra R8000 34x50t Shimano Ultegra R8000 39x53t FSA Gossamer Pro 32x48t
<b>Headset</b>	FSA 1-1/8 - 1-1/2" Integrated Aluminium Cup ACB Bearings
<b>Handlebar</b>	FSA Gossamer Compact
<b>Handlebar Plugs</b>	Bar Tape
<b>Stem</b>	Orbea OC-II

<b>Shifters</b>	Shimano Ultegra R8000
<b>Brakes</b>	Shimano Ultegra R8000
<b>Rear Derailleur</b>	Shimano Ultegra R8000 GS
<b>Front Derailleur</b>	Shimano Ultegra R8000
<b>Chain</b>	Fsa Team Issue
<b>Wheels</b>	Mavic Aksium
<b>Cassette</b>	Shimano 105 R7000 11-28t 11-Speed Shimano 105 R7000 11-30t 11-Speed Shimano 105 R7000 11-32 11-Speed (RD GS)
<b>Tyres</b>	Vittoria Rubino Foldable 700x25 60TPI G+
<b>Pedals</b>	N/A
<b>Seatpost</b>	Orbea OC-II Carbon 27.2x350mm
<b>Saddle</b>	Selle Royal Seta RS

## ORCA M32

MyOrca

Code	J126		
Size	Crank	Stem	Handlebar
47	170	90	400
49	170	100	400
51	170	100	420
53	170	110	420
55	172	110	420
57	172	110	440
60	175	120	440



<b>Frame</b>	Orbea Orca carbon OME, monocoque, tapered 1-1/8" - 1,5", PF 86mm, powermeter compatible, brake internal cable routing, EC/DC compatible, 130mm rear spacing, 27,2mm seat tube.
<b>Fork</b>	Orca OME carbon fork, full carbon steerer, tapered 1-1/8" - 1,5", carbon dropouts.
<b>Crankset</b>	Campagnolo Centaur 34x50t FSA Gossamer Pro 32x48t
<b>Headset</b>	FSA 1-1/8 - 1-1/2" Integrated Aluminium Cup ACB Bearings
<b>Handlebar</b>	FSA Omega Compact
<b>Handlebar Plugs</b>	Bar Tape
<b>Stem</b>	Orbea OC-II
<b>Shifters</b>	Campagnolo Centaur

<b>Brakes</b>	Campagnolo Centaur
<b>Rear Derailleur</b>	Campagnolo Centaur 11speed MC
<b>Front Derailleur</b>	Campagnolo Centaur
<b>Chain</b>	Fsa Team Issue
<b>Wheels</b>	Campagnolo Calima
<b>Cassette</b>	Campagnolo Centaur 11-29 11-Speed Campagnolo Centaur 11-32t 11-Speed
<b>Tyres</b>	Vittoria Rubino Foldable 700x25 60TPI G+
<b>Pedals</b>	N/A
<b>Seatpost</b>	Orbea OC-II Carbon 27.2x350mm
<b>Saddle</b>	Selle Royal Seta RS

## ORCA M30

MyOrca

Code	J127		
Size	Crank	Stem	Handlebar
47	170	90	400
49	170	100	400
51	170	100	420
53	170	110	420
55	172	110	420
57	172	110	440
60	175	120	440



<b>Frame</b>	Orbea Orca carbon OME, monocoque, tapered 1-1/8" - 1,5", PF 86mm, powermeter compatible, brake internal cable routing, EC/DC compatible, 130mm rear spacing, 27,2mm seat tube.
<b>Fork</b>	Orca OME carbon fork, full carbon steerer, tapered 1-1/8" - 1,5", carbon dropouts.
<b>Crankset</b>	Shimano 105 R7000 34x50t Shimano 105 R7000 39x53t FSA Gossamer Pro 32x48t FSA Gossamer Pro 34x50t
<b>Headset</b>	FSA 1-1/8 - 1-1/2" Integrated Aluminium Cup ACB Bearings
<b>Handlebar</b>	FSA Omega Compact
<b>Handlebar Plugs</b>	Bar Tape

<b>Stem</b>	Orbea OC-II
<b>Shifters</b>	Shimano 105 R7000
<b>Brakes</b>	Shimano 105 R7000
<b>Rear Derailleur</b>	Shimano 105 R7000 GS
<b>Front Derailleur</b>	Shimano 105 R7000
<b>Chain</b>	Fsa Team Issue
<b>Wheels</b>	Mavic Aksium
<b>Cassette</b>	Shimano 105 R7000 11-28t 11-Speed Shimano 105 R7000 11-30t 11-Speed Shimano 105 R7000 11-32 11-Speed (RD GS)
<b>Tyres</b>	Vittoria Rubino Foldable 700x25 60TPI G+
<b>Pedals</b>	N/A
<b>Seatpost</b>	Orbea OC-II Carbon 27.2x350mm

<b>Saddle</b>	Selle Royal Seta RS
---------------	---------------------

# ORCA M40

Code	J125		
<b>Size</b>	<b>Crank</b>	<b>Stem</b>	<b>Handlebar</b>
47	170	90	380
49	170	100	400
51	170	100	420
53	170	110	420
55	172	110	420
57	172	110	440
60	175	120	440



<b>Frame</b>	Orbea Orca carbon OME, monocoque, tapered 1-1/8" - 1,5", PF 86mm, powermeter compatible, brake internal cable routing, EC/DC compatible, 130mm rear spacing, 27,2mm seat tube.
<b>Fork</b>	Orca OME carbon fork, full carbon steerer, tapered 1-1/8" - 1,5", carbon dropouts.
<b>Crankset</b>	Shimano Tiagra 4700 34x50t FSA Gossamer Pro 32x48t
<b>Headset</b>	FSA 1-1/8 - 1-1/2" Integrated Aluminium Cup ACB Bearings
<b>Handlebar</b>	Orbea OC-II
<b>Handlebar Plugs</b>	Bar Tape
<b>Stem</b>	Orbea OC-II
<b>Shifters</b>	Shimano Tiagra 4700

<b>Brakes</b>	Shimano Tiagra 4700
<b>Rear Derailleur</b>	Shimano Tiagra 4700 GS
<b>Front Derailleur</b>	Shimano Tiagra 4700
<b>Chain</b>	KMC X10 EPT
<b>Wheels</b>	Shimano RS100 Clincher
<b>Cassette</b>	Shimano Tiagra HG-500 11-32t 10-Speed
<b>Tyres</b>	Vittoria Zafiro IV 700x25 26TPI
<b>Pedals</b>	N/A
<b>Seatpost</b>	Orbea OC-I 27.2x350mm
<b>Saddle</b>	Selle Royal Seta RS







## WILL YOU ACCEPT THE **CHALLENGE?**

You knew when you planned the ride it would be a long day - a route stacked with grinding climbs and twisting descents, terrible roads with a good amount of who-knows-what-else thrown in. These rides aren't most people's idea of fun, but they sure are memorable, mon-umental, challenging. Is that why you keep going? You suck down another coffee and pull on your shoe covers to hold the weather at bay, it's going to clear out and warm up in a few hours... Probably. Grab your Avant and do a quick check before rolling into the morn-ing mist. No other machine could better help you endure the hours of rough, exhausting conditions ahead. It's going to be a long day - and you love it.

**AVANT**



## USER

Avant is the choice of riders who are seeking a light endurance bike with the best performance and top specs. They are looking for the comfort and compliance that they might not find in a racing bike like Orca.

## AVANT TECH



- 01 MONOCOQUE
- 02 DYNAMIC STRUCTURE
- 03 EFFICIENCY
- 04 AVANT FORK
- 05 ENDURANCE GEOMETRY

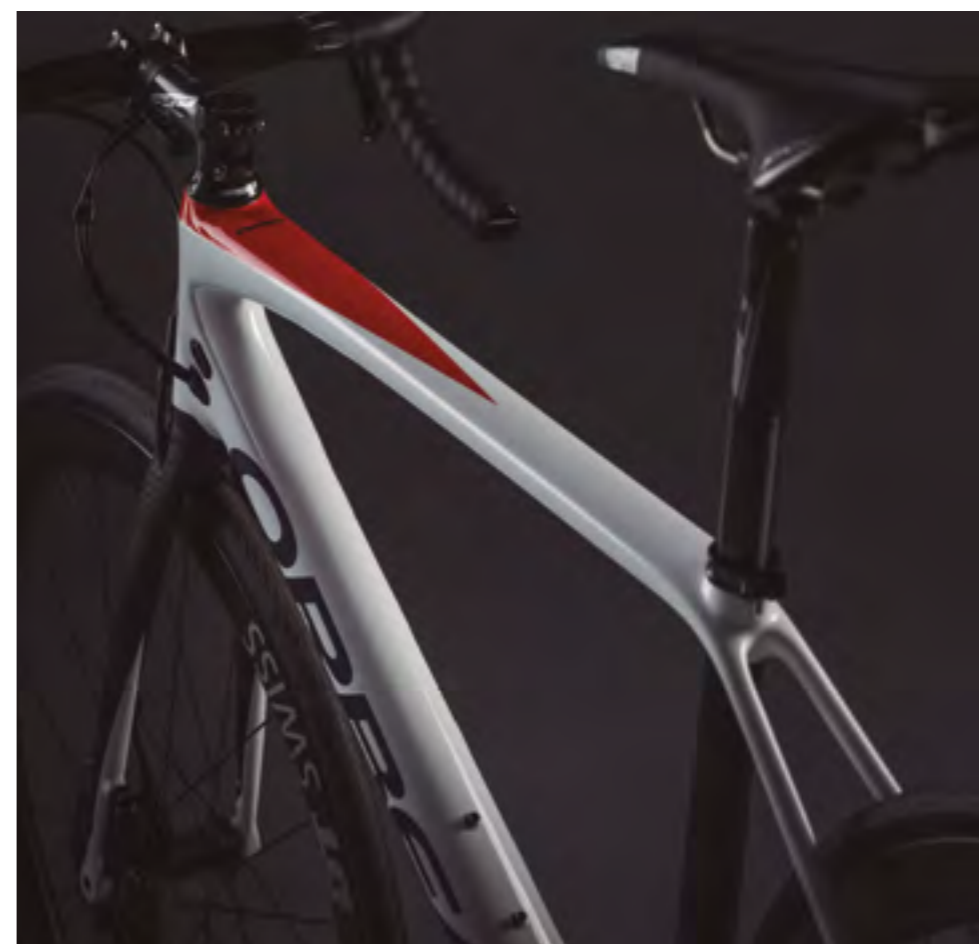

### MONOCOQUE

Avant uses technologically advanced carbon construction techniques so that you can climb faster and ride longer. Orbea Monocoque Performance (OMP) adds high modulus and high strength fibers to a standard layup to improve stiffness-to-weight ratios. Bladder molding with polyurethane headtube and bottom bracket inserts eliminates wrinkles in critical zones, allowing less carbon to be used while maintaining strength.

## EFFICIENCY

The large majority of torsional and lateral loads are handled by the lower spine of the frame. The headtube, downtube and chainstays are shaped to resist twisting and transmit power to the rear wheel. There is no doubt about it, large cross-sections and resistance to flex in the bottom of the frame translate directly to more watts on the road and a sensation that power transfer is instantaneous.

“HIGHLY RECOMMENDED”.  
CYCLING PLUS

ORCA AERO	125
	120
	115
	110
	106
	104
	102
	100
	98
ORCA DMR	96
ORCA DISC	94
	92
▶ AVANT DISC	90
	88
	86
	84
	NM/°



## DYNAMIC STRUCTURE COMFORT

Carbon structure, tubing shapes and frame design are elemental to building a comfortable frame that helps reduce muscle fatigue. Avant's Dynamic Structure provides a smooth, light ride without bulky compromises like tubing inserts and elastomers. The natural flex patterns created

by the carbon layup and minimal bulk of the top tube and seat stays deliver a dynamic, smooth ride that feels like floating over rough roads. The sensation is subtle - but it is noticeable and can be tested.



## AVANT FORK

The Avant fork uses a shallower, rounded-blade profile and longer fork legs to offer the best combination of elasticity, tire clearance and torsional stiffness. The increased axle-to-crown height is offset by a shorter headtube to maintain stack measurements and improve aesthetics.



## ORBEA ENDURANCE GEOMETRY

Avant Endurance Geometry is born from years of analyzing how ergonomics can help you ride further. Unlike a racing geometry that is focused on aerodynamics, endurance ergonomics result in a bike that is easier to ride and increases stamina. Handling is precise and intuitive. Angles and dimensions are considered carefully across a range of sizes to maximize rider comfort. And more comfort means longer rides.

Avant is designed to fit humans of all shapes and sizes. It's important to realize that women should receive the same expert bike-fitting advice as men and a custom fit for a rider of either sex is easily accommodated with MyO component selection.

>>



*MyO*

# DESIGN YOUR BIKE





- 01 CHOOSE A MODEL AND SELECT OR SUBSTITUTE YOUR FAVORITE COMPONENTS.
- 02 CREATE A CUSTOM PAINT SCHEME.
- 03 ADD YOUR NAME TO THE TOPE TUBE.

[WWW.ORBEA.COM](http://WWW.ORBEA.COM)

# AVANT OMP

SIZES	47	49	51	53	55	57	60
1 - Seat Tube (C-T)	410	440	470	490	510	530	560
2 - Top Tube (EFF)	508	520	533	547	559	578	592
3 - Head Tube	108	121	138	158	181	200	221
4 - Chainstay	415	415	415	415	415	415	415
5 - BB Height	270	270	270	272	272	272	272
6 - BB Drop	75	75	75	73	73	73	73
7 - Wheelbase	978	979	989	992	1002	1013	1025
8 - Head Angle	71°	71.5°	71.9°	72.4°	72.6°	72.8°	73°
9 - Seat Angle	74.5°	74°	73.75°	73.5°	73.5°	73°	73°
10 - Standover	727,5	750	771,6	793,3	814	832,4	857,3
11 - Reach	364	368	372	378	383	390	398
12 - Stack	520	535	553	572	595	614	635
13 - Fork Length	380	380	380	380	380	380	380

HEIGHT (cm)	HEIGHT (in)	SIZE
155-160	61.1"-63.0"	47
160-166	63.0"-65.4"	49
167-172	65.7"-67.7"	51
173-179	68.1"-70.5"	53
180-185	70.9"-72.8"	55
186-191	73.2"-75.2"	57
192-207	75.6"-81.5"	60

-  Black-Grey B2
-  White-Black B3
-  Blue-Red (Gloss) B4
-  Jade-Black B5
-  MyO CM

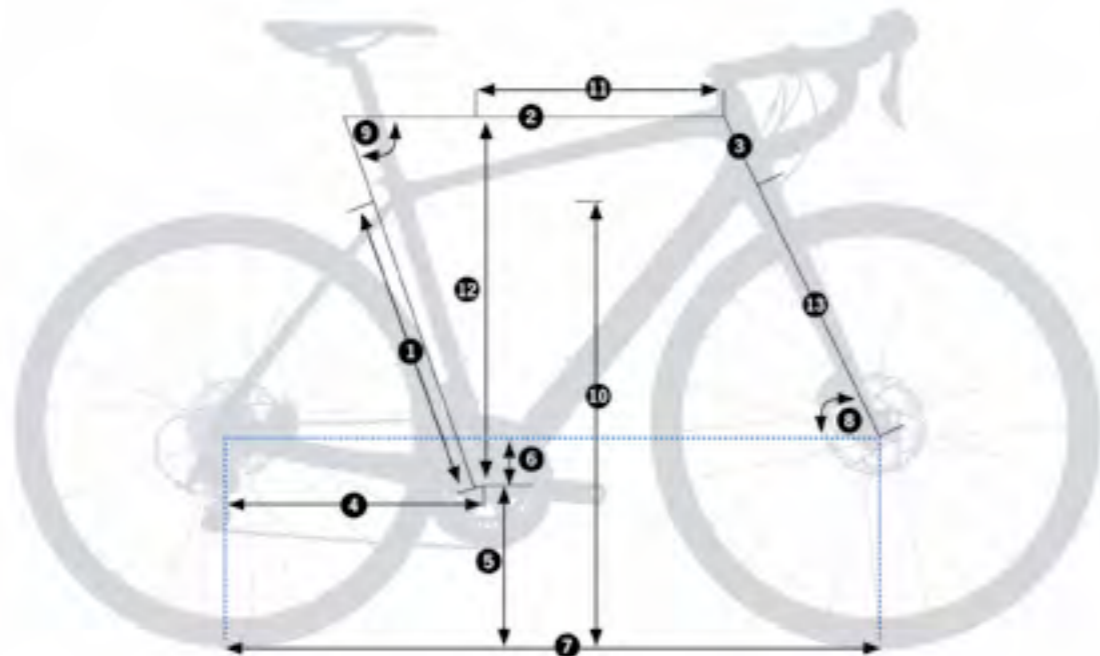

# AVANT M10I TEAM-D

Code	J109		
Size	Crank	Stem	Handlebar
47	170	90	400
49	170	100	400
51	170	100	420
53	170	110	420
55	172	110	420
57	172	110	440
60	175	120	440



<b>Frame</b>	Orbea Avant carbon OMP disc, monocoque construction, tapered 1-1/8" - 1,5", BB 386mm, powermeter compatible, Thru Axle 12mm x 142mm rear, internal cable routing, EC/DC compatible, 27,2mm seat tube.
<b>Fork</b>	Avant OMP carbon disc fork, full carbon steerer, tapered 1-1/8" - 1,5", carbon dropouts Thru axle 12mm x 100m.
<b>Crankset</b>	Shimano Dura-Ace 9100 34x50t Shimano Dura-Ace R9100 39x53t Rotor Aldhu 36x52t Rotor 2INpower DM 34x50t Rotor 2INpower DM 36x52t
<b>Headset</b>	FSA 1-1/8 - 1-1/2" Integrated Carbon Cup ACB Bearings
<b>Handlebar</b>	FSA Energy Compact Vision Metron 4D Compact FSA K-Force Compact

# AVANT M10 TEAM-D

Code	J108		
Size	Crank	Stem	Handlebar
47	170	90	400
49	170	100	400
51	170	100	420
53	170	110	420
55	172	110	420
57	172	110	440
60	175	120	440



<b>Frame</b>	Orbea Avant carbon OMP disc, monocoque construction, tapered 1-1/8" - 1,5", BB 386mm, powermeter compatible, Thru Axle 12mm x 142mm rear, internal cable routing, EC/DC compatible, 27,2mm seat tube.
<b>Fork</b>	Avant OMP carbon disc fork, full carbon steerer, tapered 1-1/8" - 1,5", carbon dropouts Thru axle 12mm x 100m.
<b>Crankset</b>	Shimano Dura-Ace 9100 34x50t Shimano Dura-Ace R9100 39x53t Rotor Aldhu 36x52t Rotor 2INpower DM 34x50t Rotor 2INpower DM 36x52t
<b>Headset</b>	FSA 1-1/8 - 1-1/2" Integrated Carbon Cup ACB Bearings
<b>Handlebar</b>	FSA Energy Compact Vision Metron 4D Compact FSA K-Force Compact



<b>Handlebar Plugs</b>	Black Anti-Slippery/Shock Proof Bar Tape
<b>Stem</b>	FSA Energy FSA OS-99 CSI
<b>Shifters</b>	Shimano R9170
<b>Brakes</b>	Shimano R9170 Hydraulic Disc
<b>Rear Derailleur</b>	Shimano Dura-Ace 9150 Di2
<b>Front Derailleur</b>	Shimano Dura-Ace 9150 Di2
<b>Chain</b>	Shimano HG901-11
<b>Wheels</b>	DT ERC 1400 Spline DB 47 Carbon CL TL Fulcrum Racing Quattro Carbon DB DT Swiss ER1600 Spline 32
<b>Cassette</b>	Mavic Ksyrium Elite Black UST Clincher + Tires Shimano Dura-Ace 9100 11-28t 11-Speed Shimano Dura-Ace R9100 11-25t 11-Speed

<b>Tyres</b>	Shimano Dura-Ace R9100 11-30t 11-Speed Hutchinson Fusion 5 All Season TLR 700x25 Hutchinson Fusion 5 All Season TLR 700x28 Hutchinson Sector 700x32 TLR
<b>Pedals</b>	N/A
<b>Seatpost</b>	FSA SL-K SB20 27,2x350mm Di2 compatible FSA S-LK Offset SB0 27,2x350/400mm FSA K-Force Offset SB0 27,2x350/400mm FSA K-Force Offset SB25 27,2x350/400mm
<b>Saddle</b>	Prologo Nago Evo Space Tirox size 141mm Prologo Scratch-2 Tirox size 143 mm Black Selle Italia SLR Kit Carbonio Black Prologo Dimension T4,0 Black



<b>Handlebar Plugs</b>	Black Anti-Slippery/Shock Proof Bar Tape
<b>Stem</b>	FSA Energy FSA OS-99 CSI
<b>Shifters</b>	Shimano R9120
<b>Brakes</b>	Shimano R9170 Hydraulic Disc
<b>Rear Derailleur</b>	Shimano Dura-Ace 9100
<b>Front Derailleur</b>	Shimano Dura-Ace 9100
<b>Chain</b>	Shimano HG901-11
<b>Wheels</b>	DT ER 1600 Spline DB 32 CL TL Fulcrum Racing Quattro Carbon DB Mavic Ksyrium Elite Black UST Clincher + Tires DT Swiss ERC1400 Spline 47
<b>Cassette</b>	Shimano Dura-Ace 9100 11-28t 11-Speed Shimano Dura-Ace R9100 11-25t 11-Speed

<b>Tyres</b>	Shimano Dura-Ace R9100 11-30t 11-Speed Hutchinson Fusion 5 All Season TLR 700x25 Hutchinson Fusion 5 All Season TLR 700x28 Hutchinson Sector 700x32 TLR
<b>Pedals</b>	N/A
<b>Seatpost</b>	FSA SL-K SB20 27,2x350mm Di2 compatible FSA S-LK Offset SB0 27,2x350/400mm FSA K-Force Offset SB0 27,2x350/400mm FSA K-Force Offset SB25 27,2x350/400mm
<b>Saddle</b>	Prologo Nago Evo Space Tirox size 141mm Prologo Scratch-2 Tirox size 143 mm Black Selle Italia SLR Kit Carbonio Black Prologo Dimension T4,0 Black

## AVANT M20I TEAM-D

Code	J107		
Size	Crank	Stem	Handlebar
47	170	90	400
49	170	100	400
51	170	100	420
53	170	110	420
55	172	110	420
57	172	110	440
60	175	120	440



<b>Frame</b>	Orbea Avant carbon OMP disc, monocoque construction, tapered 1-1/8" - 1.5", BB 386mm, powermeter compatible, Thru Axle 12mm x 142mm rear, internal cable routing, EC/DC compatible, 27,2mm seat tube.
<b>Fork</b>	Avant OMP carbon disc fork, full carbon steerer, tapered 1-1/8" - 1.5", carbon dropouts Thru axle 12mm x 100m.
<b>Crankset</b>	Shimano Ultegra R8000 34x50t Rotor Aldhu 36x52t Rotor 2INpower DM 34x50t Rotor 2INpower DM 36x52t Shimano Ultegra R8000 39x53t FSA Gossamer Pro 32x48t
<b>Headset</b>	FSA 1-1/8 - 1-1/2" Integrated Carbon Cup ACB Bearings
<b>Handlebar</b>	FSA Gossamer Compact Vision Metron 4D Compact FSA Energy Compact FSA K-Force Compact

## AVANT M20 TEAM-D

Code	J106		
Size	Crank	Stem	Handlebar
47	170	90	400
49	170	100	400
51	170	100	420
53	170	110	420
55	172	110	420
57	172	110	440
60	175	120	440



<b>Frame</b>	Orbea Avant carbon OMP disc, monocoque construction, tapered 1-1/8" - 1.5", BB 386mm, powermeter compatible, Thru Axle 12mm x 142mm rear, internal cable routing, EC/DC compatible, 27,2mm seat tube.
<b>Fork</b>	Avant OMP carbon disc fork, full carbon steerer, tapered 1-1/8" - 1.5", carbon dropouts Thru axle 12mm x 100m.
<b>Crankset</b>	Shimano Ultegra R8000 34x50t Rotor Aldhu 36x52t Rotor 2INpower DM 34x50t Rotor 2INpower DM 36x52t Shimano Ultegra R8000 39x53t FSA Gossamer Pro 32x48t
<b>Headset</b>	FSA 1-1/8 - 1-1/2" Integrated Carbon Cup ACB Bearings
<b>Handlebar</b>	FSA Gossamer Compact Vision Metron 4D Compact FSA Energy Compact FSA K-Force Compact



<b>Handlebar Plugs</b>	Black Anti-Slippery/Shock Proof Bar Tape
<b>Stem</b>	Orbea OC-III FSA Energy FSA OS-99 CSI
<b>Shifters</b>	Shimano ST-8070
<b>Brakes</b>	Shimano R8070 Hydraulic Disc
<b>Rear Derailleur</b>	Shimano Ultegra Di2 R8050 SS Shimano Ultegra RD-R8050 GS
<b>Front Derailleur</b>	Shimano Ultegra Di2 R8050
<b>Chain</b>	KMC X11-EL
<b>Wheels</b>	FULCRUM Racing 500 DB Fulcrum Racing Quattro Carbon DB DT Swiss ER1600 Spline 32 Mavic Ksyrium Elite Black UST Clincher + Tires DT Swiss ERC1400 Spline 47
<b>Cassette</b>	Shimano Ultegra R8000 11-28t 11-Speed Shimano Ultegra R8000 11-25t 11-Speed Shimano Ultegra R8000 11-30t 11-Speed

<b>Shifters</b>	Shimano Ultegra R8000 11-32t 11-Speed (RD GS)
<b>Tyres</b>	Vittoria Rubino Foldable 700x25 60TPI G+ Hutchinson Fusion 5 All Season TLR 700x28 Hutchinson Fusion 5 All Season TLR 700x25 Hutchinson Sector 700x32 TLR Hutchinson Sector 700x28 TLR
<b>Pedals</b>	N/A
<b>Seatpost</b>	FSA SL-K SB20 27,2x350mm Di2 compatible FSA S-LK Offset SB0 27,2x350/400mm FSA K-Force Offset SB0 27,2x350/400mm FSA K-Force Offset SB25 27,2x350/400mm Prologo Kappa Space STN size 147mm Prologo Scratch-2 Tirox size 143 mm Black Selle Italia SLR Kit Carbonio Black Prologo Dimension T4,0 Black Prologo Nago Evo Space Tirox size 141mm
<b>Saddle</b>	



<b>Handlebar Plugs</b>	Black Anti-Slippery/Shock Proof Bar Tape
<b>Stem</b>	Orbea OC-III FSA Energy FSA OS-99 CSI
<b>Shifters</b>	Shimano ST-8020
<b>Brakes</b>	Shimano R8070 Hydraulic Disc
<b>Rear Derailleur</b>	Shimano Ultegra R8000 SS Shimano Ultegra RD-R8000 GS
<b>Front Derailleur</b>	Shimano Ultegra R8000
<b>Chain</b>	KMC X11-EL
<b>Wheels</b>	DT P 1850 Spline DB 23 CL TL Fulcrum Racing Quattro Carbon DB DT Swiss ER1600 Spline 32 Mavic Ksyrium Elite Black UST Clincher + Tires DT Swiss ERC1400 Spline 47
<b>Cassette</b>	Shimano Ultegra R8000 11-28t 11-Speed

<b>Shifters</b>	Shimano Ultegra R8000 11-25t 11-Speed Shimano Ultegra R8000 11-30t 11-Speed Shimano Ultegra R8000 11-32t 11-Speed (RD GS)
<b>Tyres</b>	Hutchinson Fusion 5 All Season TLR 700x25 Hutchinson Fusion 5 All Season TLR 700x28 Hutchinson Sector 700x32 TLR Hutchinson Sector 700x28 TLR
<b>Pedals</b>	N/A
<b>Seatpost</b>	Orbea OC-III Carbon 27.2x350mm FSA K-Force Offset SB0 27,2x350/400mm FSA K-Force Offset SB25 27,2x350/400mm
<b>Saddle</b>	Selle Italia X3 Flow Prologo Scratch-2 Tirox size 143 mm Black Selle Italia SLR Kit Carbonio Black Prologo Dimension T4,0 Black Prologo Nago Evo Space Tirox size 141mm

## AVANT M30 TEAM-D

Code	J105		
Size	Crank	Stem	Handlebar
47	170	90	400
49	170	100	400
51	170	100	420
53	170	110	420
55	172	110	420
57	172	110	440
60	175	120	440



<b>Frame</b>	Orbea Avant carbon OMP disc, monocoque construction, tapered 1-1/8" - 1.5", BB 386mm, powermeter compatible, Thru Axle 12mm x 142mm rear, internal cable routing, EC/DC compatible, 27,2mm seat tube.
<b>Fork</b>	Avant OMP carbon disc fork, full carbon steerer, tapered 1-1/8" - 1.5", carbon dropouts Thru axle 12mm x 100m.
<b>Crankset</b>	Shimano 105 R7000 34x50t Rotor Aldhu 36x52t Rotor 2INpower DM 34x50t Rotor 2INpower DM 36x52t Shimano 105 R7000 39x53t FSA Gossamer Pro 32x48t
<b>Headset</b>	FSA 1-1/8 - 1-1/2" Integrated Carbon Cup ACB Bearings
<b>Handlebar</b>	FSA Gossamer Compact Vision Metron 4D Compact FSA Energy Compact FSA K-Force Compact



<b>Handlebar Plugs</b>	Black Anti-Slippery/Shock Proof Bar Tape
<b>Stem</b>	Orbea OC-III FSA Energy FSA OS-99 CSI
<b>Shifters</b>	Shimano ST-7020
<b>Brakes</b>	Shimano R7070 Hydraulic Disc
<b>Rear Derailleur</b>	Shimano 105 R7000 GS
<b>Front Derailleur</b>	Shimano 105 R7000
<b>Chain</b>	KMC X11-EL
<b>Wheels</b>	FULCRUM Racing 600 DB Fulcrum Racing Quattro Carbon DB DT Swiss ER1600 Spline 32 Mavic Ksyrium Elite Black UST DB + Tires DT Swiss ERC1400 Spline 47 DT Swiss P1850 23
<b>Cassette</b>	Shimano 105 R7000 11-28t 11-Speed Shimano 105 R7000 11-30t 11-Speed

<b>Shifters</b>	Shimano 105 R7000 11-32 11-Speed (RD GS)
<b>Tyres</b>	Vittoria Rubino Foldable 700x25 60TPI G+ Hutchinson Fusion 5 All Season TLR 700x28 Hutchinson Fusion 5 All Season TLR 700x25 Hutchinson Sector 700x32 TLR Hutchinson Sector 700x28 TLR
<b>Pedals</b>	N/A
<b>Seatpost</b>	Orbea OC-III Carbon 27.2x350mm FSA K-Force Offset SB0 27,2x350/400mm FSA K-Force Offset SB25 27,2x350/400mm
<b>Saddle</b>	Selle Italia X3 Flow Prologo Scratch-2 Tirox size 143 mm Black Selle Italia SLR Kit Carbonio Black Prologo Dimension T4,0 Black Prologo Nago Evo Space Tirox size 141mm

# AVANT H

SIZES	47	49	51	53	55	57	60
1 - Seat Tube (C-T)	410	440	470	490	510	530	560
2 - Top Tube (EFF)	516.2	527.3	536.5	549.1	563.9	579.6	594.4
3 - Head Tube	113	131.7	150.1	165	188	205	226
4 - Chainstay	414	414	414	414	418	418	418
5 - BB Height	257.5	257.5	257.5	257.5	257.5	257.5	257.5
6 - BB Drop	72.5	72.5	72.5	72.5	72.5	72.5	72.5
7 - Wheelbase	978	986.5	992.8	993.7	1005,3	1014	1023,8
8 - Head Angle	71.2°	71.4°	71.8°	72°	72.5°	73°	73.5°
9 - Seat Angle	73.5°	73.5°	73.5°	73.5°	73.2°	73°	73°
10 - Standover	721,9	730,3	754,2	774,5	798,5	820,5	847,9
11 - Reach	363	367,1	370,9	378.4	383.4	391.7	400.2
12 - Stack	517,4	535,8	554,8	572,8	596,1	614,6	636,5
13 - Fork Length	375	375	375	375	375	375	375

HEIGHT (cm)	HEIGHT (in)	SIZE
155-160	61.1"-63.0"	47
160-166	63.0"-65.4"	49
167-172	65.7"-67.7"	51
173-179	68.1"-70.5"	53
180-185	70.9"-72.8"	55
186-191	73.2"-75.2"	57
192-207	75.6"-81.5"	60

- 

Black-Anthracite-Green (Matt-Gloss) **H1**
- 

White-Black-Blue (Gloss) **H2**
- 

Black-Red-White (Matt-Gloss) **H3**
- 

Blue-Green (Gloss) **H4**
- 

Black-Pink-Jade Green (Matt) **H5**

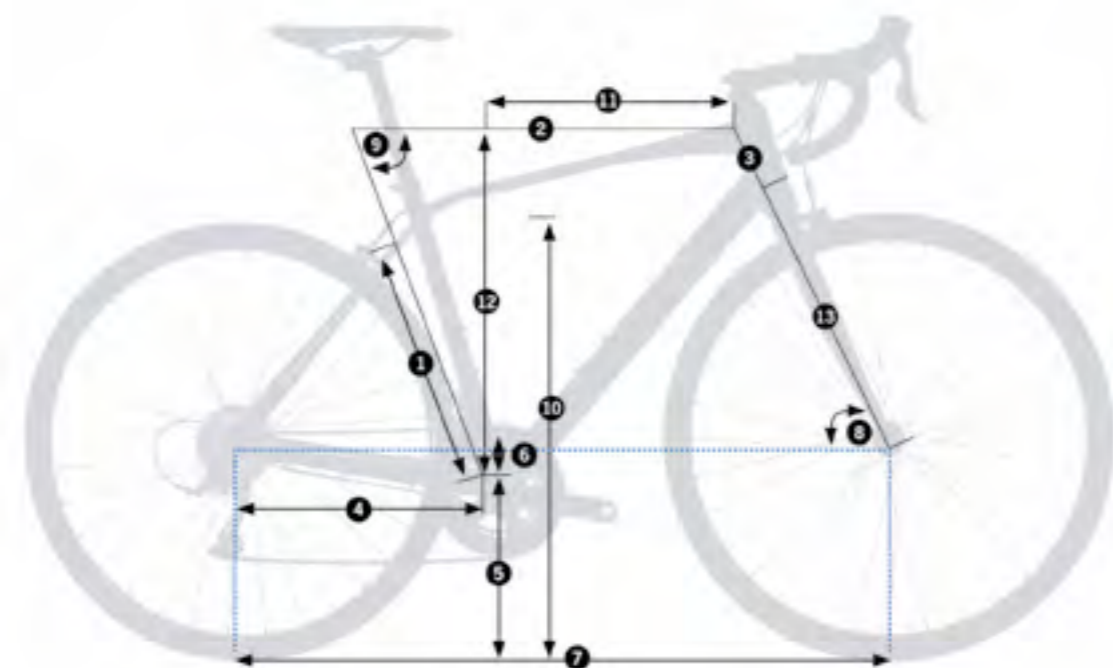

# AVANT H30

Code	J103		
Size	Crank	Stem	Handlebar
47	170	90	380
49	170	100	400
51	170	100	420
53	170	100	420
55	172	110	420
57	172	110	440
60	175	120	440



<b>Frame</b>	Orbea Avant Hydro, hydroformed triple butted aluminum, headset 1-1/8", BB 68mm - BSC English, internal cable routing, 130 OLD, 27,2mm seat tube.
<b>Fork</b>	Avant carbon fork, aluminum steerer, 1-1/8" head tube.
<b>Crankset</b>	FSA Omega Megaexo 34x50t
<b>Headset</b>	1-1/8" Semi-Integrated Aluminium Cup
<b>Handlebar</b>	Orbea OC-II
<b>Handlebar Plugs</b>	Bar Tape
<b>Stem</b>	Orbea OC-II
<b>Shifters</b>	Shimano 105 R7000
<b>Brakes</b>	Orbea OC-II
<b>Rear Derailleur</b>	Shimano 105 R7000 GS
<b>Front Derailleur</b>	Shimano 105 R7000



<b>Chain</b>	Fsa Team Issue
<b>Wheels</b>	Shimano RS100 Clincher
<b>Cassette</b>	Shimano 105 R7000 11-32t 11-Speed
<b>Tyres</b>	Vittoria Zafiro IV 700x25 26TPI
<b>Pedals</b>	N/A
<b>Seatpost</b>	Orbea OC-I 27.2x350mm
<b>Saddle</b>	Selle Royal Seta RS

# AVANT H40

Code	J102		
Size	Crank	Stem	Handlebar
47	170	90	380
49	170	100	400
51	170	100	420
53	170	100	420
55	172	110	420
57	172	110	440
60	175	120	440



<b>Frame</b>	Orbea Avant Hydro, hydroformed triple butted aluminum, headset 1-1/8", BB 68mm - BSC English, internal cable routing, 130 OLD, 27,2mm seat tube.
<b>Fork</b>	Avant carbon fork, aluminum steerer, 1-1/8" head tube.
<b>Crankset</b>	FSA Omega Megaexo 34x50t
<b>Headset</b>	1-1/8" Semi-Integrated Aluminium Cup
<b>Handlebar</b>	Orbea OC-II
<b>Handlebar Plugs</b>	Bar Tape
<b>Stem</b>	Orbea OC-II
<b>Shifters</b>	Shimano Tiagra 4700
<b>Brakes</b>	Orbea OC-II
<b>Rear Derailleur</b>	Shimano Tiagra 4700 GS
<b>Front Derailleur</b>	Shimano Tiagra 4700



<b>Chain</b>	KMC X10 EPT
<b>Wheels</b>	Shimano RS100 Clincher
<b>Cassette</b>	Shimano Tiagra HG-500 11-32t 10-Speed
<b>Tyres</b>	Vittoria Zafiro IV 700x25 26TPI
<b>Pedals</b>	N/A
<b>Seatpost</b>	Orbea OC-I 27.2x350mm
<b>Saddle</b>	Selle Royal Seta RS



## AVANT H50

Code	J101		
Size	Crank	Stem	Handlebar
47	170	90	380
49	170	100	400
51	170	100	420
53	170	100	420
55	175	110	420
57	175	110	440
60	175	120	440



<b>Frame</b>	Orbea Avant Hydro, hydroformed triple butted aluminum, headset 1-1/8", BB 68mm - BSC English , internal cable routing, 130 OLD, 27,2mm seat tube.
<b>Fork</b>	Avant carbon fork, aluminum steerer, 1-1/8" head tube.
<b>Crankset</b>	Shimano Sora R3000 34x50t
<b>Headset</b>	1-1/8" Semi-Integrated Aluminium Cup
<b>Handlebar</b>	Orbea OC-II
<b>Handlebar Plugs</b>	Bar Tape
<b>Stem</b>	Orbea OC-II
<b>Shifters</b>	Shimano Sora
<b>Brakes</b>	Orbea OC-II
<b>Rear Derailleur</b>	Shimano Sora 3000GS
<b>Front Derailleur</b>	Shimano Sora 3000



<b>Chain</b>	Shimano HG53 9-Speed
<b>Wheels</b>	Orbea R1800
<b>Cassette</b>	Shimano HG400 11-32t 9-Speed
<b>Tyres</b>	Vittoria Zafiro IV 700x25 26TPI
<b>Pedals</b>	VP-335T
<b>Seatpost</b>	Orbea OC-I 27.2x350mm
<b>Saddle</b>	Selle Royal Seta RS

## AVANT H60

Code	J100		
Size	Crank	Stem	Handlebar
47	170	90	380
49	170	100	400
51	170	100	420
53	170	100	420
55	170	110	420
57	170	110	440
60	175	120	440



<b>Frame</b>	Orbea Avant Hydro, hydroformed triple butted aluminum, headset 1-1/8", BB 68mm - BSC English , internal cable routing, 130 OLD, 27,2mm seat tube.
<b>Fork</b>	Avant carbon fork, aluminum steerer, 1-1/8" head tube.
<b>Crankset</b>	Shimano Claris R2000 34x50t
<b>Headset</b>	1-1/8" Semi-Integrated Aluminium Cup
<b>Handlebar</b>	Orbea OC-II
<b>Handlebar Plugs</b>	Bar Tape
<b>Stem</b>	Orbea OC-II
<b>Shifters</b>	Shimano Claris ST-R2000
<b>Brakes</b>	Orbea OC-II
<b>Rear Derailleur</b>	Shimano Claris RD-R2000-GS
<b>Front Derailleur</b>	Shimano Claris FD-R2000-F



<b>Chain</b>	KMC X8
<b>Wheels</b>	Orbea R1800
<b>Cassette</b>	Shimano HG50 11-32t 8-Speed
<b>Tyres</b>	Vittoria Zafiro IV 700x25 26TPI
<b>Pedals</b>	VP-335T
<b>Seatpost</b>	Orbea OC-I 27.2x350mm
<b>Saddle</b>	Selle Royal Seta RS



## YOU WON'T KNOW UNLESS YOU GO

Of course you're not lost, you just aren't quite sure if this road is the quickest route to the next ridge. The weather is great, you've got all day and you're riding Terra, so keep the wheels rolling. If route-finding, taking the long way home and straying from the beaten path are your ideas of fun, there is no better tool than Terra for unlocking your desire to explore.

**TERRA**



“THE ORBEA TERRA WAS ABSOLUTELY PERFECT: THE RIDE WAS EXTREMELY COMFORTABLE AND FORGIVING BUT AT THE SAME TIME OFFERING EXCELLENT PERFORMANCE CHARACTERISTICS”.

GRAVEL CYCLIST

## USER

Who is Terra for? Terra is for riders who do enough riding off-tarmac to need something tougher than a traditional road or endurance bike. Terra is for those taking a fresh approach to exploration and fun and need a bike that is versatile enough to fill several roles. Terra will also satisfy cyclo-cross enthusiasts who need a bike with excellent tire clearance that is light and fast.

## TERRA TECH



- 01 MONOCOQUE
- 02 COMFORT
- 03 VERSATILITY
- 04 STIFFNESS
- 05 ALL ROAD GEOMETRY

## MONOCOQUE

Orbea Monocoque Performance (OMP) adds high modulus and high strength fibers to a standard layup to improve stiffness-to-weight ratios. Bladder mold-ing with polyurethane headtube and bottom bracket inserts eliminates wrinkles in critical zones, allowing less carbon to be used while maintaining strength.

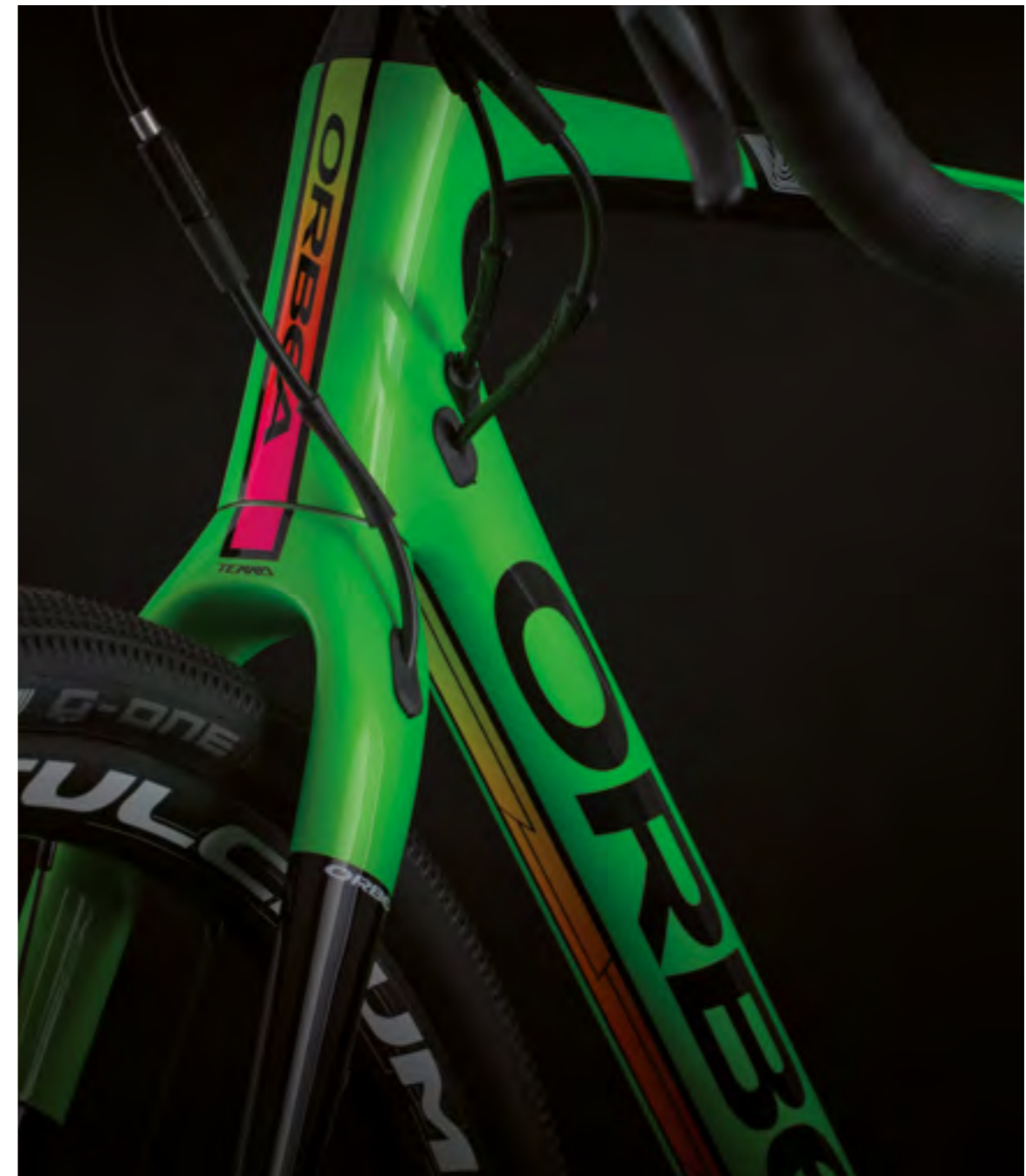

## MONOCOQUE-WEIGHT

Light, durable, precise. carbon durability and precision. 1190 g. the perfect blend of low weight and durability for a long life of fun.

Terra uses technologically advanced carbon construction techniques to build a versatile and light weight frame that can improve your experience on almost any ride.

/ **LIGHTNESS.** Optimized layups and fewer frame pieces reduces weight.

/ **STIFFNESS.** Single uniform structures are better optimized to resist deflection. Carbon structures are tuned to deliver maximum stiffness without adding weight.

/ **RELIABILITY.** Eliminating bonded areas increases strength. The lifetime warranty assures your Orbea will be a long-time companion.

/ **FULL CARBON.** Engineering a frame that uses as much carbon as possible of course saves weight but it also contributes to the sophistication and refinement of Orca.



## DYNAMIC ESTRUCTURE

Carbon structure, tubing shapes and frame design are elemental to building a comfortable frame that helps reduce muscle fatigue. Terra's Dynamic Structure provides a smooth, light ride without bulky compromises like tubing inserts and elastomers.

The natural flex patterns created by the carbon layup and minimal bulk of the top tube and seat stays deliver a dynamic, smooth ride that feels like floating

over rough roads. The sensation is subtle - but it is noticeable and can be tested. And at the end of a long day it could mean the difference between climbing one last col and climbing off the bike.

/ Small sections absorb vibration

/ Optimized shapes for compliance & comfort

/ Lighter than elastomer inserts a smoother terra means more comfort and control

**CARBON  
DURABILITY  
AND PRECISION  
1.190 G**



## VERSATILITY

Terra can fill several roles - Gravel, Road, CX, Winter Training or Commuting. Tire Clearance, the ability to mount accessories like mud guards combined with a functional All-Road Geometry means that Terra can change with the seasons.



## TERRA FORK

The Terra fork uses a robust crown, rounded blade profile and longer fork legs to offer the best combination of elasticity, tire clearance and torsional stiffness.

/ Longer legs for more vibration absorption & bump compliance

/ Stiff crown for rigidity & precise tracking

/ Fits 40c tires with 5mm clearance each side

/ The terra fork offers better comfort and control



## ALL ROAD GOMETRY

Control in a variety of circumstances. Terra is designed to be at home on dirt, gravel or just about anything else you might encounter.

/ Terra ergonomics work for cyclocross, all-day rides and the occasional long training day on the road.

/ Handling is precise and intuitive. Angles and dimensions are considered carefully across a range of sizes to maximize rider comfort.

Longer wheelbase more stability and comfort. Longer chainstays smoother ride and better traction. Lower bottom bracket. Confident descending on rough surfaces. Higher stack & shorter reach more stability in sand and gravel. All-road ergonomics more fun in all terrain!

## COMFORT AND POWER TRANSFER

The large majority of torsional and lateral loads are handled by the lower spine of the frame. The headtube, downtube and chainstays are shaped to resist twisting and transmit power to the rear wheel. There is no doubt about it, large cross-sections and resistance to flex in the bottom of the frame translate directly to more watts on the road and a sensation that power transfer is instantaneous.

/ Large sections create a stiff spine

/ Optimized shapes resist directional flex

/ Increased surface area improves stiffness a stiffer terra means more power to the rear wheel



## TERRA H

the Alloy version of Terra may cause you to look twice - we worked hard to match the tube shapes and clean lines of the carbon frame with hydroformed aluminum. The result is a sleek and powerful Terra Hydro that is distinctive and refined. ensures a lively ride that is adapted perfectly to all-road riding conditions.

We manipulate the shapes and wall-thickness of our aluminum tubing to increase strength and resistance to unwanted flex. Many of the tubes are butted to save weight in the middle of the tubes, away from the stress of the joints and the weld zones. Using aluminum technologies as advanced as our carbon manufacturing ensures our aluminum bikes are never second-best.



## TIRES

Different tires for a different Terra. Tire clearance for a wide variety of riding styles.

- / 40C gravel.
- / 33C cyclocross.
- / 28C road training / commuting.
- / Big tires offer lower rolling resistance and greater control.



## MMS

/ Customize accessories for multiple uses

/ User-friendly multi mount system

Mount and secure almost any type of aftermarket fender in a sleek and simple installation that is sturdy and attractive. Attach a rack for extra carrying capacity. Terra won't mind, it's what we intended when we created our most versatile all-road bike.

/ A versatile terra is several bikes in one



*MyO*

# DESIGN YOUR IDEAS

- 01 CHOOSE A MODEL AND SELECT OR SUBSTITUTE YOUR FAVORITE COMPONENTS.
- 02 CREATE A CUSTOM PAINT SCHEME.
- 03 ADD YOUR NAME TO THE TOPE TUBE.

[WWW.ORBEA.COM](http://WWW.ORBEA.COM)

# TERRA CARBON

SIZES	XS	S	M	L	XL
1 - Seat Tube (C-T)	460	510	554	590	630
2 - Top Tube (EFF)	531	543	555	570	585
3 - Head Tube	122	138	156	182	212
4 - Chainstay	430	430	430	430	430
5 - BB Height	283	283	285	285	288
6 - BB Drop	70	70	68	68	65
7 - Wheelbase	1017	1030	1043	1060	1078
8 - Head Angle	70.5°	70.5°	70.5°	70.5°	70.5°
9 - Seat Angle	73.5°	73.5°	73.5°	73.5°	73.5°
10 - Standover	764	796	828	858	893
11 - Reach	370	378	385	392	400
12 - Stack	545	560	575	600	625
13 - Fork Length	400	400	400	400	400

HEIGHT (cm)	HEIGHT (in)	SIZE
153-165	60.2"-65.0"	XS
166-173	65.4"-68.1"	S
174-177	68.5"-69.7"	S/M
178-184	70.1"-72.4"	M
185-188	72.8"-74.0"	M/L
189-192	74.4"-75.6"	L
> 192	> 75.6"	L/XL

MyO CM

- Black (Matt-Gloss) GV
- Pearl Grey-Dark Blue (Gloss) GX
- Green-Black (Gloss) GU
- Blue steel -Red (Gloss) GW
- Anthracite-Yellow (Matt) GY

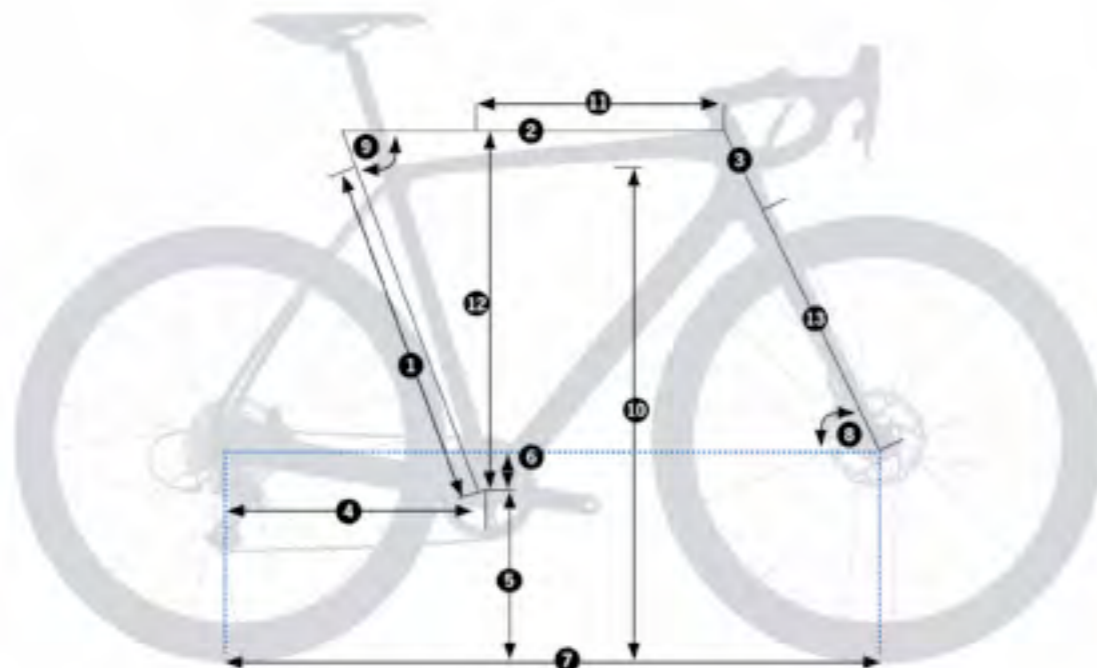

# TERRA M10-D

Code	J124		
Size	Crank	Stem	Handlebar
XS	170	100	420
S	170	110	420
M	172	110	420
L	172	110	440
XL	175	120	440



<b>Frame</b>	Terra OMP
<b>Fork</b>	Orbea Terra
<b>Crankset</b>	FSA SL-K Modular Adventure 30x46t Shimano Dura-Ace R9100 34x50t
<b>Headset</b>	FSA 1-1/8 - 1-1/2" Integrated Carbon Cup ACB Bearings
<b>Handlebar</b>	FSA Energy Compact FSA K-Force Compact
<b>Handlebar Plugs</b>	Black Anti-Slippery/Shock Proof Bar Tape
<b>Stem</b>	FSA Energy FSA OS-99 CSI
<b>Shifters</b>	Shimano R9120
<b>Brakes</b>	Shimano R9170 Hydraulic Disc



<b>Rear Derailleur</b>	Shimano Dura-Ace R9100 SS Direct Mount
<b>Front Derailleur</b>	Shimano Dura-Ace 9100
<b>Chain</b>	Shimano HG901-11
<b>Wheels</b>	DT ERC 1400 Spline DB 47 Carbon CL TL DT Swiss ER1600 Spline 32 Mavic Ksyrium Elite Black UST Clincher + Tires
<b>Cassette</b>	Shimano Dura-Ace 9100 11-30t 11-Speed Shimano Dura-Ace R8100 11-28t 11-Speed
<b>Tyres</b>	Schwalbe G-ONE Allround, 40-622, Black, Folding Hutchinson Sector 700x32 TLR Hutchinson Sector 700x28 TLR
<b>Pedals</b>	N/A
<b>Seatpost</b>	Orbea OC-III Carbon 27.2x350mm

<b>Saddle</b>	FSA S-LK Offset SB0 27,2x350/400mm FSA K-Force Offset SB25 27,2x350/400mm Fizik Antares R5 Versus EVO Regular Prologo Nago Evo Space Tirox 141mm Fizik Arione Donna
<b>Mudguard</b>	

# TERRA M201-D

Code	J122		
Size	Crank	Stem	Handlebar
XS	170	100	420
S	170	110	420
M	172	110	420
L	172	110	440
XL	175	120	440



<b>Frame</b>	Terra OMP
<b>Fork</b>	Orbea Terra
<b>Crankset</b>	FSA SL-K Modular Adventure 30x46t FSA Gossamer Pro 34x50t Shimano Ultegra R8000 34x50t
<b>Headset</b>	FSA 1-1/8 - 1-1/2" Integrated Carbon Cup ACB Bearings
<b>Handlebar</b>	FSA Energy Compact FSA K-Force Compact
<b>Handlebar Plugs</b>	Black Anti-Slippery/Shock Proof Bar Tape
<b>Stem</b>	FSA Energy FSA OS-99 CSI
<b>Shifters</b>	Shimano ST-8070

<b>Brakes</b>	Shimano R8070 Hydraulic Disc
<b>Rear Derailleur</b>	Shimano Ultegra RX805 GS Direct mount
<b>Front Derailleur</b>	Shimano Ultegra Di2 R8050
<b>Chain</b>	KMC X11-EL
<b>Wheels</b>	DT P 1850 Spline DB 23 CL TL DT Swiss ER1600 Spline 32 Mavic Ksyrium Elite Black UST Clincher + Tires
<b>Cassette</b>	DT Swiss ERC1400 Spline 47 Shimano Ultegra R8000 11-32t 11-Speed Shimano Ultegra R8000 11-28t 11-Speed
<b>Tyres</b>	Schwalbe G-ONE Allround, 40-622, Black, Folding Hutchinson Sector 700x32 TLR Hutchinson Sector 700x28 TLR

<b>Pedals</b>	N/A
<b>Seatpost</b>	Orbea OC-III Carbon 27.2x350mm FSA S-LK Offset SB0 27,2x350/400mm FSA K-Force Offset SB0 27,2x350/400mm FSA K-Force Offset SB25 27,2x350/400mm
<b>Saddle</b>	Fizik Antares R5 Versus EVO Regular Prologo Nago Evo Space Tirox 141mm Fizik Arione Donna
<b>Mudguard</b>	





## TERRA M21-D



Code	J123		
Size	Crank	Stem	Handlebar
XS	170	100	420
S	170	110	420
M	172	110	420
L	172	110	440
XL	175	120	440



<b>Frame</b>	Terra OMP
<b>Fork</b>	Orbea Terra
<b>Crankset</b>	SRAM Force 1 40t
<b>Headset</b>	FSA 1-1/8 - 1-1/2" Integrated Carbon Cup ACB Bearings
<b>Handlebar</b>	FSA Energy Compact FSA K-Force Compact
<b>Handlebar Plugs</b>	Black Anti-Slippery/Shock Proof Bar Tape
<b>Stem</b>	FSA Energy FSA OS-99 CSI
<b>Brakes</b>	SRAM Force Hydraulic
<b>Rear Derailleur</b>	SRAM Force 1
<b>Chain</b>	KMC X11-EL

<b>Wheels</b>	DT P 1850 Spline DB 23 CL TL DT Swiss ER1600 Spline 32 Mavic Ksyrium Elite Black UST Clincher + Tires DT Swiss ERC1400 Spline 47
<b>Cassette</b>	SRAM Force PG-1170 11-36t 11-Speed
<b>Tyres</b>	Schwalbe G-ONE Allround, 40-622, Black, Folding Hutchinson Sector 700x32 TLR Hutchinson Sector 700x28 TLR
<b>Pedals</b>	N/A
<b>Seatpost</b>	Orbea OC-III Carbon 27.2x350mm FSA S-LK Offset SB0 27,2x350/400mm FSA K-Force Offset SB0 27,2x350/400mm

<b>Saddle</b>	FSA K-Force Offset SB25 27,2x350/400mm Fizik Antares R5 Versus EVO Regular Prologo Nago Evo Space Tirox 141mm Fizik Arione Donna
<b>Mudguard</b>	

## TERRA M20-D



Code	J121		
Size	Crank	Stem	Handlebar
XS	170	100	420
S	170	110	420
M	172	110	420
L	172	110	440
XL	175	120	440



<b>Frame</b>	Terra OMP
<b>Fork</b>	Orbea Terra
<b>Crankset</b>	FSA Gossamer Pro Adventure 32x48t FSA Gossamer Pro 34x50t Shimano Ultegra R8000 34x50t FSA SL-K Modular Adventure 30x46t
<b>Headset</b>	FSA 1-1/8 - 1-1/2" Integrated Carbon Cup ACB Bearings
<b>Handlebar</b>	FSA Energy Compact FSA K-Force Compact
<b>Handlebar Plugs</b>	Black Anti-Slippery/Shock Proof Bar Tape
<b>Stem</b>	FSA Energy FSA OS-99 CSI

<b>Shifters</b>	Shimano ST-8020
<b>Brakes</b>	Shimano R8070 Hydraulic Disc
<b>Rear Derailleur</b>	Shimano Ultegra RX800 GS Direct mount
<b>Front Derailleur</b>	Shimano Ultegra R8000
<b>Chain</b>	KMC X11-EL
<b>Wheels</b>	FULCRUM Racing 600 DB DT Swiss ER1600 Spline 32 Mavic Ksyrium Elite Black UST Clincher + Tires DT Swiss ERC1400 Spline 47 DT Swiss P1850 Spline 23
<b>Cassette</b>	Shimano Ultegra R8000 11-32t 11-Speed Shimano Ultegra R8000 11-28t 11-Speed
<b>Tyres</b>	Kenda Flintridge K1152 700x40 DTC 60TPI

<b>Pedals</b>	N/A
<b>Seatpost</b>	Orbea OC-III Carbon 27.2x350mm FSA S-LK Offset SB0 27,2x350/400mm FSA K-Force Offset SB0 27,2x350/400mm FSA K-Force Offset SB25 27,2x350/400mm
<b>Saddle</b>	Fizik Antares R5 Versus EVO Regular Prologo Nago Evo Space Tirox 141mm Fizik Arione Donna
<b>Mudguard</b>	

## TERRA M30-D



Code	J119		
Size	Crank	Stem	Handlebar
XS	170	100	420
S	170	100	420
M	172	110	420
L	172	110	440
XL	175	120	440



<b>Frame</b>	Terra OMP
<b>Fork</b>	Orbea Terra
<b>Crankset</b>	FSA Gossamer Pro Adventure 32x48t FSA Gossamer Pro 34x50t FSA SL-K Modular Adventure 30x46t Shimano 105 R7000 34x50t
<b>Headset</b>	FSA 1-1/8 - 1-1/2" Integrated Carbon Cup ACB Bearings
<b>Handlebar</b>	FSA Gossamer Compact FSA Energy Compact FSA K-Force Compact
<b>Handlebar Plugs</b>	Black Anti-Slippery/Shock Proof Bar Tape
<b>Stem</b>	Orbea OC-II FSA Energy

<b>Shifters</b>	FSA OS-99 CSI Shimano ST-7020
<b>Brakes</b>	Shimano R7070 Hydraulic Disc
<b>Rear Derailleur</b>	Shimano 105 R7000 GS Direct Mount
<b>Front Derailleur</b>	Shimano 105 R7000
<b>Chain</b>	Fsa Team Issue
<b>Wheels</b>	Mavic All Road Disc Clincher DT Swiss ER1600 Spline 32 Mavic Ksyrium Elite Black UST Clincher + Tires DT Swiss ERC1400 Spline 47 DT Swiss P1850 Spline 23
<b>Cassette</b>	Shimano 105 R7000 11-32t 11-Speed Shimano 105 R7000 11-28t 11-Speed
<b>Tyres</b>	Kenda Flintridge K1152 700x40 DTC 60TPI

<b>Pedals</b>	N/A
<b>Seatpost</b>	Orbea OC-III Carbon 27.2x350mm FSA S-LK Offset SB0 27,2x350/400mm FSA K-Force Offset SB0 27,2x350/400mm FSA K-Force Offset SB25 27,2x350/400mm
<b>Saddle</b>	Selle Italia X3 Flow Prologo Nago Evo Space Tirox 141mm Fizik Arione Donna Fizik Antares R5 Versus EVO Regular
<b>Mudguard</b>	

## TERRA M31-D



Code	J120		
Size	Crank	Stem	Handlebar
XS	170	100	420
S	170	100	420
M	172	110	420
L	172	110	440
XL	175	120	440



<b>Frame</b>	Terra OMP
<b>Fork</b>	Orbea Terra
<b>Crankset</b>	SRAM Rival 1 40t
<b>Headset</b>	FSA 1-1/8 - 1-1/2" Integrated Carbon Cup ACB Bearings
<b>Handlebar</b>	FSA Gossamer Compact FSA Energy Compact FSA K-Force Compact
<b>Handlebar Plugs</b>	Black Anti-Slippery/Shock Proof Bar Tape
<b>Stem</b>	Orbea OC-II FSA Energy FSA OS-99 CSI
<b>Shifters</b>	SRAM Rival

<b>Brakes</b>	SRAM Rival Hydraulic
<b>Rear Derailleur</b>	SRAM Rival 1 X-Horizon
<b>Chain</b>	Fsa Team Issue
<b>Wheels</b>	FULCRUM Racing 600 DB DT Swiss ER1600 Spline 32 Mavic Ksyrium Elite Black UST Clincher + Tires DT Swiss ERC1400 Spline 47 DT Swiss P1850 Spline 23
<b>Cassette</b>	SRAM Rival PG-1130 11-36t 11-Speed
<b>Tyres</b>	Kenda Flintridge K1152 700x40 DTC 60TPI Hutchinson Sector 700x32 TLR Hutchinson Sector 700x28 TLR Schwalbe G-One 700x40 Allround TL Easy

<b>Pedals</b>	N/A
<b>Seatpost</b>	Orbea OC-III Carbon 27.2x350mm FSA S-LK Offset SB0 27,2x350/400mm FSA K-Force Offset SB0 27,2x350/400mm FSA K-Force Offset SB25 27,2x350/400mm
<b>Saddle</b>	Selle Italia X3 Flow Prologo Nago Evo Space Tirox 141mm Fizik Arione Donna Fizik Antares R5 Versus EVO Regular
<b>Mudguard</b>	

# TERRA H

SIZES	XXS	XS	S	M	L	XL
1 - Seat Tube (C-T)	455	485	515	545	575	605
2 - Top Tube (EFF)	512	529	542	560	575	588
3 - Head Tube	100	120	139	162	187	205
4 - Chainstay	430	430	430	430	430	430
5 - BB Height	285	285	285	285	285	285
6 - BB Drop	70	70	68	66	66	66
7 - Wheelbase	1005	1015	1020	1034	1046	1052
8 - Head Angle	70,5	71	72	72	72,3	73
9 - Seat Angle	74,5	74	74	73,5	73,5	73,5
10 - Standover	763	787	813	839	866	890
11 - Reach	366	373	380	387	394	401
12 - Stack	525	545	565	585	610	630
13 - Fork Length	400	400	400	400	400	400

HEIGHT (cm)	HEIGHT (in)	SIZE
153-165	60.2"-65.0"	XXS
166-173	65.4"-68.1"	XS
174-177	68.5"-69.7"	S/M
178-184	70.1"-72.4"	M
185-188	72.8"-74.0"	M/L
189-192	74.4"-75.6"	L
> 192	> 75.6"	XL

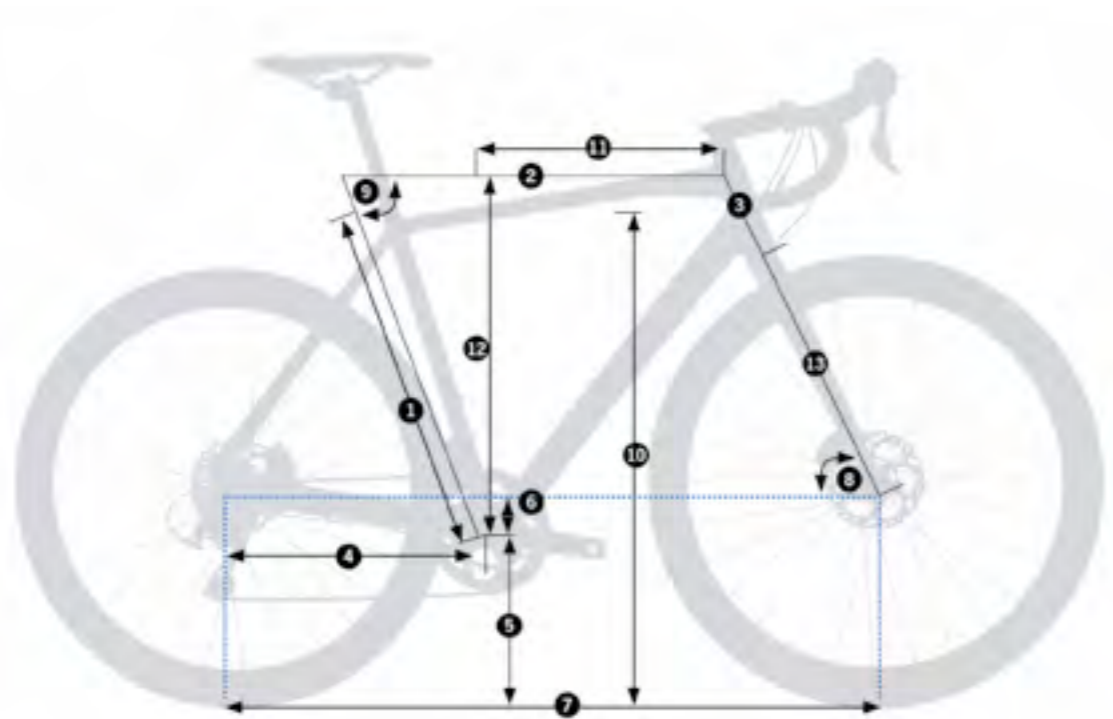

# TERRA H31-D

Code	J118		
Size	Crank	Stem	Handlebar
XXS	170	90	400
XS	170	100	400
S	170	100	420
M	172	110	420
L	172	110	440
XL	175	120	440



<b>Fork</b>	Orbea Terra
<b>Crankset</b>	SRAM Rival 40t
<b>Headset</b>	FSA 1-1/8 - 1-1/2" Integrated Aluminium Cup ACB Bearings
<b>Handlebar</b>	Orbea OC-II
<b>Handlebar Plugs</b>	Bar Tape
<b>Stem</b>	Orbea OC-II
<b>Shifters</b>	SRAM Rival
<b>Brakes</b>	SRAM Rival Hydraulic
<b>Rear Derailleur</b>	SRAM Rival 1 X-Horizon
<b>Chain</b>	Fsa Team Issue
<b>Wheels</b>	Shimano RS170
<b>Cassette</b>	SRAM Rival PG-1130 11-36t 11-Speed



<b>Tyres</b>	Kenda Flintridge K1152 700x40 DTC 60TPI
<b>Pedals</b>	N/A
<b>Seatpost</b>	Orbea OC-I 27.2x350mm
<b>Saddle</b>	Selle Royal Seta RS
<b>Mudguard</b>	

# TERRA H30-D

Code	J117		
Size	Crank	Stem	Handlebar
XXS	170	90	400
XS	170	100	400
S	170	100	420
M	172	110	420
L	172	110	440
XL	175	120	440



<b>Fork</b>	Orbea Terra
<b>Crankset</b>	FSA Omega Adventure Megaexo 32x48t
<b>Headset</b>	FSA 1-1/8 - 1-1/2" Integrated Aluminium Cup ACB Bearings
<b>Handlebar</b>	Orbea OC-II
<b>Handlebar Plugs</b>	Bar Tape
<b>Stem</b>	Orbea OC-II
<b>Shifters</b>	Shimano ST-7020
<b>Brakes</b>	Shimano R7070 Hydraulic Disc
<b>Rear Derailleur</b>	Shimano 105 R7000 GS Direct Mount
<b>Front Derailleur</b>	Shimano 105 R7000
<b>Chain</b>	Fsa Team Issue
<b>Wheels</b>	Shimano RS170



<b>Cassette</b>	Shimano 105 R7000 11-32t 11-Speed
<b>Tyres</b>	Kenda Flintridge K1152 700x40 DTC 60TPI
<b>Pedals</b>	N/A
<b>Seatpost</b>	Orbea OC-I 27.2x350mm
<b>Saddle</b>	Selle Royal Seta RS
<b>Mudguard</b>	

## TERRA H40-D

<b>Code</b>	J116		
<b>Size</b>	<b>Crank</b>	<b>Stem</b>	<b>Handlebar</b>
XXS	170	90	400
XS	170	100	400
S	170	100	420
M	172	110	420
L	172	110	440
XL	175	120	440



<b>Fork</b>	Orbea Terra
<b>Crankset</b>	FSA Omega Adventure Megaexo 32x48t
<b>Headset</b>	FSA 1-1/8 - 1-1/2" Integrated Aluminium Cup ACB Bearings
<b>Handlebar</b>	Orbea OC-II
<b>Handlebar Plugs</b>	Bar Tape
<b>Stem</b>	Orbea OC-II
<b>Shifters</b>	Shimano ST-RS405
<b>Brakes</b>	Shimano RS405 Hydraulic Disc
<b>Rear Derailleur</b>	Shimano Tiagra 4700 GS
<b>Front Derailleur</b>	Shimano Tiagra 4700
<b>Chain</b>	KMC X10
<b>Wheels</b>	Shimano RS170

<b>Cassette</b>	Shimano Tiagra HG-500 11-34t 10-Speed
<b>Tyres</b>	Kenda Flintridge K1152 700x40 DTC 60TPI
<b>Pedals</b>	N/A
<b>Seatpost</b>	Orbea OC-I 27.2x350mm
<b>Saddle</b>	Selle Royal Seta RS
<b>Mudguard</b>	



# TRIATHLON

ORDU



## THE TIME OF YOUR LIFE

Ordu translates to “moment” in the Basque language. It’s the perfect name for a bike created to capture the efforts of training and distill them into the present, a single focus on having the time of your life. The time you push so deep into the tunnel you can’t recall the minutes spent on the road. When heart rate, wattage and gear selection completely vanish from your perception and it is only you and the bike. We all know moments like this - the rarest of events when somehow you ride beyond your capabilities and do the perfect effort. Everything clicks into place and you have the time of your life.

**ORDU**



“THE ORDU IS FAST. LIKE, INSTANTLY IMPRESSIVE, “OH WOW, GIMME MORE OF THIS FAST...WITH IMPRESSIVE STIFFNESS, HANDLING, ADJUSTABILITY AND SPEC”.

CYCLING PLUS (UK)



## USER

The new Ordu is for the serious triathlete looking to upgrade an existing bike to something faster, lighter and more specific. Ordu is also the choice of elite or professional road racers who need a UCI-legal time trial bike. Ordu is the racing platform of Team Vital Concept and Orbea/Orca Triathletes.

# ORDU TECH



01 FREEFLOW FORK

02 MONDRAGON TUBE SHAPES

03 MINI TAPER

04 TRUE MULTISPORT GEOMETRY





**FREEFLOW FORK**

Aerodynamic forks are typically designed to perform like aero frame tubes - optimized for directional movement through the wind. But the forward rotation of the spokes and today's wider rims and tires approaching from behind the fork (against the flow of wind as the wheel spins) creates a high pressure/high drag zone. Freeflow spreads the fork legs away from this area to reduce pressure and turbulence. Normal directional aerodynamics remain unchanged but the bike gets faster because the airspace inside the Freeflow fork blades is less chaotic.



**ORDU  
STANDARD  
FORK**

**ORDU  
FREEFLOW  
FORK**

**10%  
FASTER**

**MONDRAGON TUBE SHAPES**

Not many bike companies have the research and development capabilities of an Engineering School at their fingertips. Orbea works directly with specialists at Mondragon University in the Basque Country to analyze and test aerodynamic concepts. Our subtle improvements to a traditional airfoil are aimed specifically at helping riders go faster in conditions typically encountered on the road – Faster at lower speeds and faster at higher yaw angles.

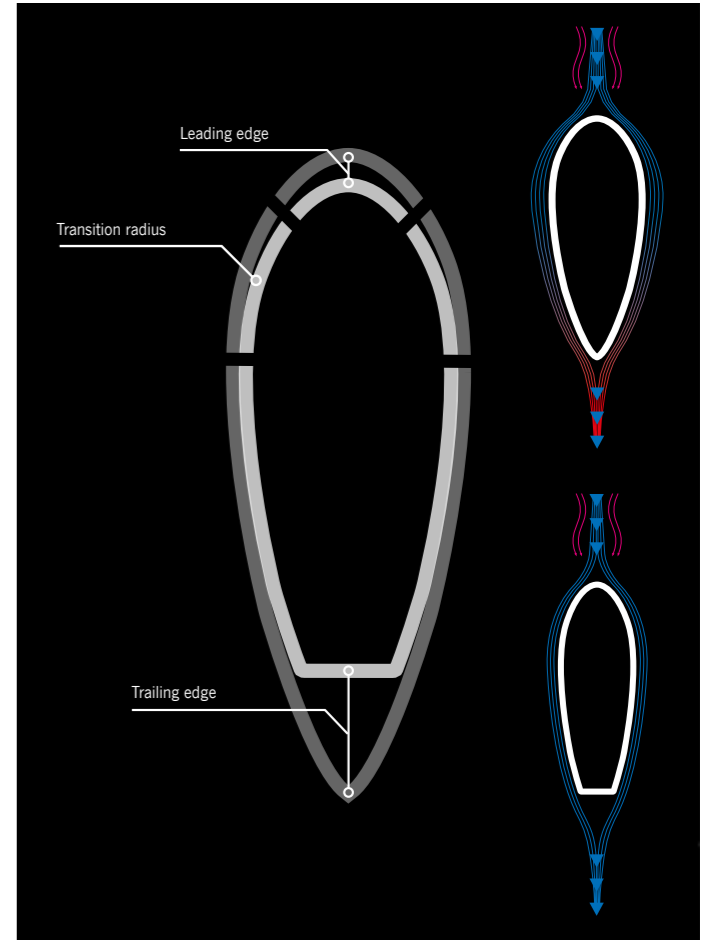

**DOUBLE RADIUS** - The double-radiused “bullet” leading edge opens airflow around the tube profile and improves airflow at higher yaw angles.

**FLATTENED SIDES** - Flattening the sides of the airfoil reduces frontal area of the tube and offers better drag numbers at lower speeds.

**ABBREVIATED TAIL** - A squared trailing edge “tricks” wind into thinking the shape continues to a point, but allows for a shallower tube and smooths airflow into bottle cages.



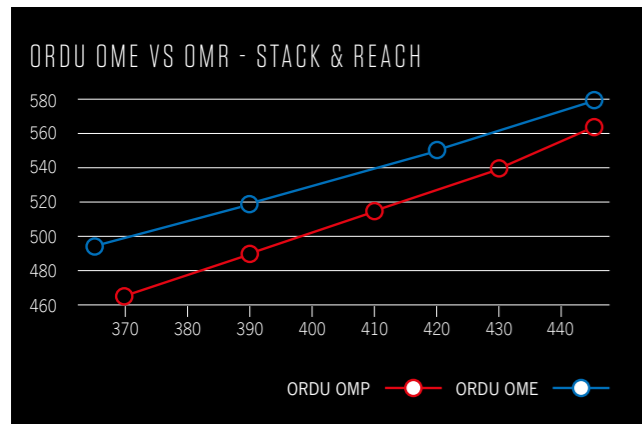

SIZE RANGE

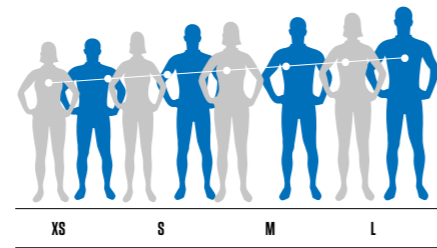

∇

### MINI TAPER

The headtubes of most performance bikes are tapered to optimize stiffness and minimize weight. But the frontal area of a standard 28.6 x 38mm tapered design interferes significantly with aerodynamics. We decided to go a different route. We developed a 25.4 x 28.6mm Mini Taper for the Ordu headtube and fork steerer tube. Air flows smoothly around the reduced frontal area and past a clever aerodynamic stem cover and continues unhindered. These solutions decrease drag by reducing frontal area by 10% over a straight 28.6mm design and save a few grams at the same time. No small improvement.

### TRUE MULTISPORT GEOMETRY

Take advantage of Ordu's true multisport geometry for Triathlons or Time Trials without workarounds. It's hard to give it your all if you feel like you're making do. Ordu was designed under the premise that there's no reason to settle for an almost-perfect fit. With a calculated linear progression between sizes and the frankly massive range of saddle positions made possible by our symmetrical seat post, you'll never have the nagging feeling that you'd be faster "if only..."

*MyO*

# DESIGN YOUR BIKE

- 01 CHOOSE A MODEL AND SELECT OR SUBSTITUTE YOUR FAVORITE COMPONENTS.
- 02 CREATE A CUSTOM PAINT SCHEME.
- 03 ADD YOUR NAME TO THE TOPE TUBE.

[WWW.ORBEA.COM](http://WWW.ORBEA.COM)

# ORDU OMP

SIZES	XS	S	M	L	XL
1 - Seat Tube (C-T)	493	508	533	559	587
2 - Top Tube (EFF)	469	494	519	544	575
3 - Head Tube	71.6	85	103.7	128	154
4 - Chainstay	405	405	405	405	405
5 - BB Height	280	268	268	268	268
6 - BB Drop	60	72	72	72	72
7 - Wheelbase	966	988.5	995.4	1018,7	1041
8 - Head Angle	71°	71°	72.5°	73°	73°
9 - Seat Angle	78°	78°	78°	78°	77°
10 - Standover	760	775	780	825	850
11 - Reach	370	390	410	430	445
12 - Stack	465	490	515	540	565
13 - Fork Length	375	375	375	375	375

HEIGHT (cm)	HEIGHT (in)	SIZE
152-165	59.8"-65.0"	XS
160-172	63.0"-67.7"	S
167-180	65.7"-70.9"	M
175-187	68.9"-73.6"	L
182-195	71.7"-76.8"	XL

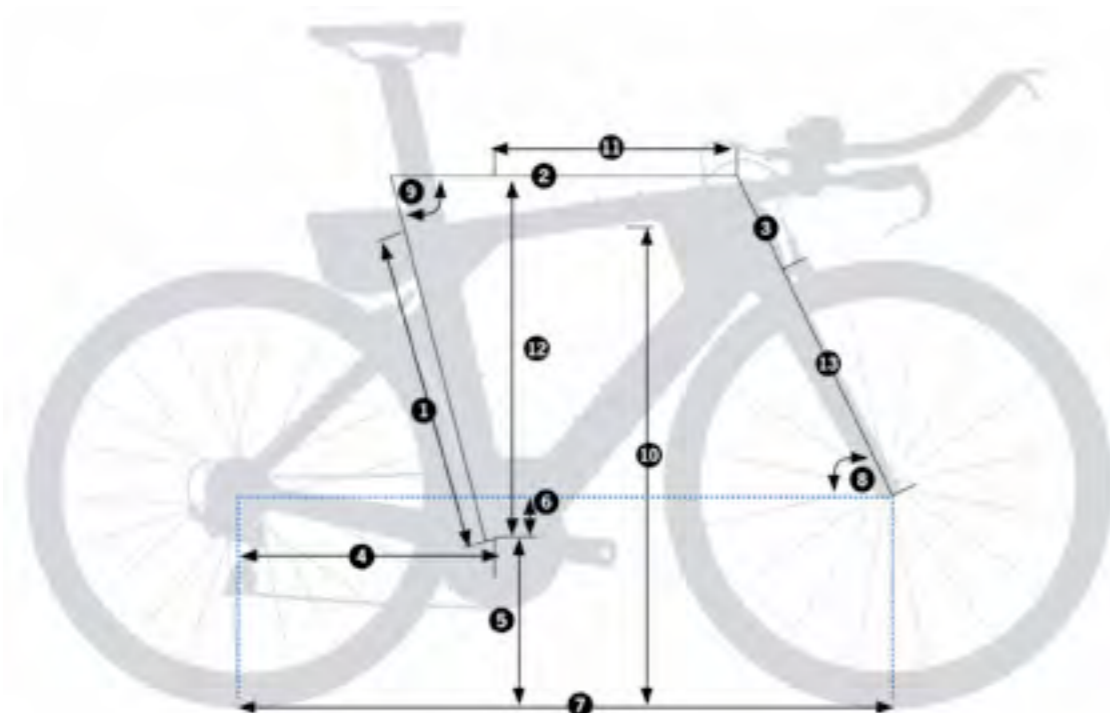
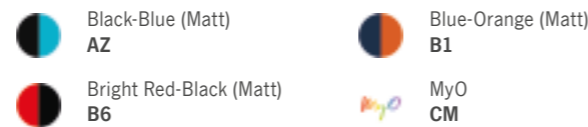

# ORDU M10I TEAM

Code	J115		
Size	Crank	Stem	Handlebar
XS	165	90	400
S	170	90	400
M	170	90	400
L	170	90	400
XL	172	90	400



<b>Frame</b>	Ordu carbon OMP, monocoque, 1" - 1 1/8" mini tapered head tube, BB386 ø46mm , powermeter compatible, internal cable routing, EC/DC compatible, 130mm rear spacing, vertical dropouts, UCI legal.
<b>Fork</b>	Ordu OMP carbon fork, aluminum steerer, 1" - 1 1/8" mini tapered head tube.
<b>Crankset</b>	Rotor Flow 36x52At Rotor Aldhu 36x52t Rotor 2INpower DM 34x50t Rotor 2INpower DM 36x52t Rotor Flow NOQ 34x50t
<b>Headset</b>	FSA 1-1/8"-1" Integrated Aluminium Cup
<b>Handlebar</b>	Vision Metron Carbon with SnakeBite stem
<b>Handlebar Plugs</b>	Bar Tape



<b>Shifters</b>	Shimano SW-671
<b>Brake levers</b>	Vision Metron Carbon
<b>Brakes</b>	Tri Rig Omega X Standart
<b>Rear Derailleur</b>	Shimano Dura-Ace 9150 Di2
<b>Front Derailleur</b>	Shimano Dura-Ace 9150 Di2
<b>Chain</b>	Shimano HG901-11
<b>Wheels</b>	DT ARC 1400 Dicut 48 Carbon TL Fulcrum Racing Quattro Carbon DT Swiss PR1600 Spline 32
<b>Cassette</b>	Shimano Dura-Ace 9100 11-28t 11-Speed
<b>Tyres</b>	Hutchinson Fusion 5 All SeasonTLR 700x25
<b>Pedals</b>	N/A
<b>Seatpost</b>	Orbea Ordu OMP

<b>Saddle</b>	Tgale Tirox size 132 mm Prologo Dimension T4,0 Black
---------------	---

# ORDU M10 TEAM

Code	J114		
Size	Crank	Stem	Handlebar
XS	165	90	400
S	170	90	400
M	170	90	400
L	170	90	400
XL	172	90	400



<b>Frame</b>	Ordu carbon OMP, monocoque, 1" - 1 1/8" mini tapered head tube, BB386 ø46mm , powermeter compatible, internal cable routing, EC/DC compatible, 130mm rear spacing, vertical dropouts, UCI legal.
<b>Fork</b>	Ordu OMP carbon fork, aluminum steerer, 1" - 1 1/8" mini tapered head tube.
<b>Crankset</b>	Rotor Flow 36x52At Rotor Aldhu 36x52t Rotor 2INpower DM 34x50t Rotor 2INpower DM 36x52t Rotor Flow NOQ 34x50t
<b>Headset</b>	FSA 1-1/8"-1" Integrated Aluminium Cup
<b>Handlebar</b>	Vision Metron Carbon with SnakeBite stem
<b>Handlebar Plugs</b>	Bar Tape



<b>Shifters</b>	Shimano Bar End SL-BSR1
<b>Brake levers</b>	Vision Metron Carbon
<b>Brakes</b>	Tri Rig Omega X Standart
<b>Rear Derailleur</b>	Shimano Dura-Ace 9100
<b>Front Derailleur</b>	Shimano Dura-Ace 9100
<b>Chain</b>	Shimano HG901-11
<b>Wheels</b>	DT PR 1600 Spline 32 Fulcrum Racing Quattro Carbon DT Swiss ARC1400 Dicut 48
<b>Cassette</b>	Shimano Dura-Ace 9100 11-28t 11-Speed
<b>Tyres</b>	Hutchinson Fusion 5 All SeasonTLR 700x25
<b>Pedals</b>	N/A
<b>Seatpost</b>	Orbea Ordu OMP

<b>Saddle</b>	Tgale Tirox size 132 mm Prologo Dimension T4,0 Black
---------------	---

## ORDU M20I TEAM



Code	J113		
Size	Crank	Stem	Handlebar
XS	165	90	400
S	170	90	400
M	170	90	400
L	170	90	400
XL	172	90	400



<b>Frame</b>	Ordu carbon OMP, monocoque, 1" - 1 1/8" mini tapered head tube, BB386 ø46mm, powermeter compatible, internal cable routing, EC/DC compatible, 130mm rear spacing, vertical dropouts, UCI legal.
<b>Fork</b>	Ordu OMP carbon fork, aluminum steerer, 1" - 1 1/8" mini tapered head tube.
<b>Crankset</b>	Rotor Flow 36x52At Rotor Aldhu 36x52t Rotor 2INpower DM 34x50t Rotor 2INpower DM 36x52t Rotor Flow NOQ 34x50t
<b>Headset</b>	FSA 1-1/8"-1" Integrated Aluminium Cup
<b>Handlebar</b>	Vision Metron Carbon with SnakeBite stem
<b>Handlebar Plugs</b>	Bar Tape

<b>Shifters</b>	Shimano SW-671
<b>Brake levers</b>	Vision Trimax Aero Alloy
<b>Brakes</b>	Tri Rig Omega X Standart
<b>Rear Derailleur</b>	Shimano Ultegra Di2 R8050 SS
<b>Front Derailleur</b>	Shimano Ultegra Di2 R8050
<b>Chain</b>	Fsa Team Issue
<b>Wheels</b>	DT PR 1600 Spline 32 Fulcrum Racing Quattro Carbon DT Swiss ARC1400 Dicut 48
<b>Cassette</b>	Shimano Ultegra R8000 11-28t 11-Speed
<b>Tyres</b>	Hutchinson Fusion 5 All SeasonTLR 700x25
<b>Pedals</b>	N/A
<b>Seatpost</b>	Orbea Ordu OMP

<b>Saddle</b>	Tgale Tirox size 132 mm Prologo Dimension T4,0 Black
---------------	---

## ORDU M20 TEAM



Code	J112		
Size	Crank	Stem	Handlebar
XS	165	90	410
S	170	100	410
M	170	100	410
L	170	110	410
XL	172	110	410



<b>Frame</b>	Ordu carbon OMP, monocoque, 1" - 1 1/8" mini tapered head tube, BB386 ø46mm, powermeter compatible, internal cable routing, EC/DC compatible, 130mm rear spacing, vertical dropouts, UCI legal.
<b>Fork</b>	Ordu OMP carbon fork, aluminum steerer, 1" - 1 1/8" mini tapered head tube.
<b>Crankset</b>	Rotor Flow 36x52At Rotor Aldhu 36x52t Rotor 2INpower DM 34x50t Rotor 2INpower DM 36x52t Rotor Flow NOQ 34x50t
<b>Headset</b>	FSA 1-1/8"-1" Integrated Aluminium Cup
<b>Handlebar</b>	Vision Trimax Carbon
<b>Handlebar Plugs</b>	Bar Tape

<b>Extension</b>	Vision Trimax Alloy Clip-on 31,8 x230-290mm J-Bend
<b>Stem</b>	Orbea OC-III
<b>Shifters</b>	Shimano Bar End SL-BSR1
<b>Brake levers</b>	Vision Trimax Aero Alloy
<b>Brakes</b>	FSA Trimax Aero
<b>Rear Derailleur</b>	Shimano Ultegra R8000 SS
<b>Front Derailleur</b>	Shimano Ultegra R8000
<b>Chain</b>	Fsa Team Issue
<b>Wheels</b>	Vision Team 35 Comp Clincher Fulcrum Racing Quattro Carbon DT Swiss PR1600 Spline 32 DT Swiss ARC1400 Dicut 48
<b>Cassette</b>	Shimano 105 R7000 11-28t 11-Speed

<b>Tyres</b>	Vittoria Rubino Pro 700x25 120TPI G+ Hutchinson Fusion 5 All Season TLR 700x25 Vittoria Corsa G+ 700x25 320 tpi
<b>Pedals</b>	N/A
<b>Seatpost</b>	Orbea Ordu OMP
<b>Saddle</b>	Tgale Tirox size 132 mm Prologo Dimension T4,0 Black

## ORDU OME

SIZES	XS	S	M	L
1 - Seat Tube (C-T)	520	550	575	610
2 - Top Tube (EFF)	470	503	539	577
3 - Head Tube	92	120	139	169
4 - Chainstay	405	405	405	405
5 - BB Height	266	266	266	266
6 - BB Drop	73	73	73	73
7 - Wheelbase	969	1002	1010	1044
8 - Head Angle	70.5°	71°	73°	73°
9 - Seat Angle	78°	78°	78°	77°
10 - Standover	749	777	802	835
11 - Reach	365	392	419	443
12 - Stack	495	523	551	580
13 - Fork Length	375	375	375	375

HEIGHT (cm)	HEIGHT (in)	SIZE
153-162	60.2"-63.8"	XS
163-174	64.2"-68.5"	S
175-185	68.9"-72.8"	M
185-195	72.8"-76.8"	L

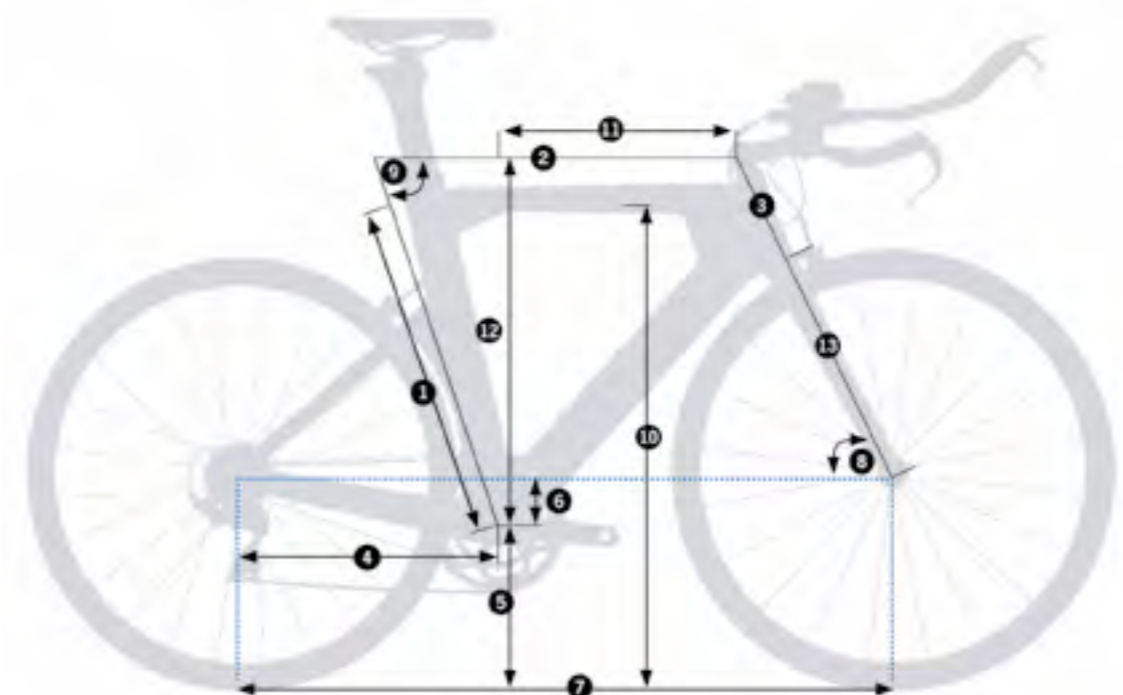
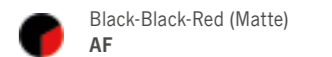

## ORDU M20

Code	J111		
Size	Crank	Stem	Handlebar
XS	165	90	400
S	170	100	400
M	170	100	400
L	172	110	400



<b>Frame</b>	Ordu carbon OME, monocoque, 1-1/8" head tube, PF 86mm, powermeter compatible, internal cable routing, EC/DC compatible, 130mm rear spacing, vertical dropouts, UCI legal, external battery compatible.
<b>Fork</b>	Ordu OME carbon fork, aluminum steerer, 1-1/8" head tube.
<b>Crankset</b>	FSA Gossamer Pro 36x52t
<b>Headset</b>	FSA 1-1/8" Integrated Carbon Cup
<b>Handlebar</b>	Vision Trimax Alloy
<b>Handlebar Plugs</b>	Bar Tape
<b>Extension</b>	Vision Trimax Alloy Clip-on 31,8 x230-290mm J-Bend
<b>Stem</b>	Orbea OC-III
<b>Shifters</b>	Shimano Bar End SL-BSR1

<b>Brake levers</b>	Vision Trimax Aero Alloy
<b>Brakes</b>	Shimano 105 R7000
<b>Rear Derailleur</b>	Shimano Ultegra R8000 SS
<b>Front Derailleur</b>	Shimano Ultegra R8000
<b>Chain</b>	Fsa Team Issue
<b>Wheels</b>	Vision Team 30 Comp Clincher
<b>Cassette</b>	Shimano 105 R7000 11-28t 11-Speed
<b>Tyres</b>	Vittoria Rubino Foldable 700x23 60TPI G+
<b>Pedals</b>	N/A
<b>Seatpost</b>	Orbea Ordu OME
<b>Saddle</b>	Prologo Zero Tri T2,0

## ORDU M30

Code	J110		
Size	Crank	Stem	Handlebar
XS	165	90	400
S	170	100	400
M	170	100	400
L	172	110	400



<b>Frame</b>	Ordu carbon OME, monocoque, 1-1/8" head tube, PF 86mm, powermeter compatible, internal cable routing, EC/DC compatible, 130mm rear spacing, vertical dropouts, UCI legal, external battery compatible.
<b>Fork</b>	Ordu OME carbon fork, aluminum steerer, 1-1/8" head tube.
<b>Crankset</b>	FSA Gossamer Compact MegaExo 36x52t
<b>Headset</b>	FSA 1-1/8" Integrated Carbon Cup
<b>Handlebar</b>	Vision Trimax Alloy
<b>Handlebar Plugs</b>	Bar Tape
<b>Extension</b>	Vision Trimax Alloy Clip-on 31,8 x230-290mm J-Bend
<b>Stem</b>	Orbea OC-III
<b>Shifters</b>	Shimano Bar End SL-BSR1

<b>Brake levers</b>	Vision Trimax Aero Alloy
<b>Brakes</b>	Orbea OC-II
<b>Rear Derailleur</b>	Shimano 105 R7000 SS
<b>Front Derailleur</b>	Shimano 105 R7000
<b>Chain</b>	Fsa Team Issue
<b>Wheels</b>	Vision Team 25 Clincher
<b>Cassette</b>	Shimano 105 R7000 11-28t 11-Speed
<b>Tyres</b>	Vittoria Rubino Foldable 700x23 60TPI G+
<b>Pedals</b>	N/A
<b>Seatpost</b>	Orbea Ordu OME
<b>Saddle</b>	Prologo Zero Tri T2,0



# MTB

- RALLON
- OCCAM
- LAUFY
- OIZ
- ALMA
- MX



## ENDURALIN

It's the difference between the tentative first go of the year and the ripping third lap of a midsummer day. It's the ease of knowing your suspension is dialed. It's a boost of confidence, speed and control when a bit more of any could make a winning formula. Enduralin is the extra bit of fun that turns a good ride into a great one – the shouting of the crowd, a flow state of euphoria, cowbells, chainsaws, accelerated reaction time and enhanced perception. It's the difference between a Good Time and All-Time.

**RALLON**



“ORBEA’S NEW RALLON IS ONE OF THE BEST LONG-TRAVEL 29”.

BIKEMAG



## USER

Rallon is for riders who enjoy descents most of all. It's a bike for those who want a machine capable of anything - challenging descents, racing and bike park laps are the domain of Rallon. Enduro racers will find that Rallon is the perfect machine for demanding EWS tracks. Rallon riders pay attention to the small details and are very aware of trends in kinematics, suspension setup and geometry.

## RALLON TECH



- 01 MONOCOQUE
- 02 ADVANCED DYNAMICS
- 03 ASYMMETRY ERGONOMICS
- 04 PURE ENDURO GEOMETRY
- 05 CONCENTRIC BOOST
- 06 MYO

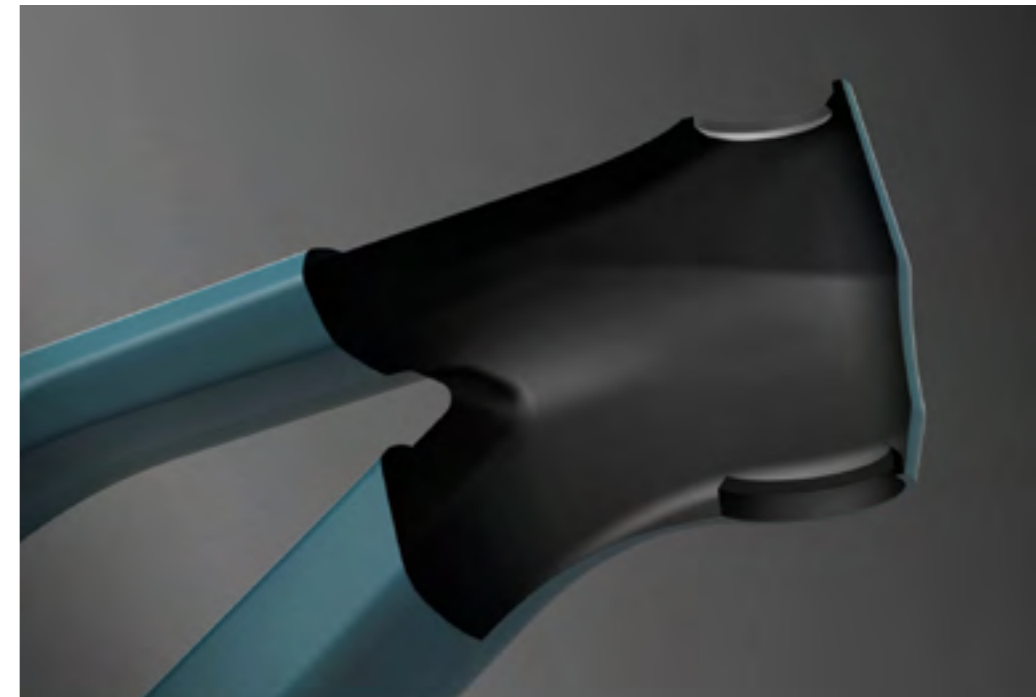

### MONOCOQUE

Of all the materials used to build bicycle frames, carbon composites offer the most advantageous blend of low weight, high strength and ease of manipulation. What we do with the composites – the selection of materials and how they are used – is key to the final result.

### LIGHTNESS

Optimized layups and fewer frame pieces reduce weight. High modulus and high strength carbon are blended to achieve the best strength-to-weight ratio.

### STIFFNESS

Single uniform structures are better optimized to resist deflection. By reducing the number of frame pieces, larger carbon structures are tuned to deliver maximum stiffness without weight penalties.

### RELIABILITY

Eliminating bonded areas increases strength and relent-less testing gives confidence. The lifetime warranty assures your Orbea will be a long-time companion.

### FULL CARBON

Engineering a frame that uses as much carbon as possible of course saves weight but it also contributes to the sophistication and refinement of Rallon.



## ADVANCED DYNAMICS

Advanced Dynamics is at the heart of every Orbea suspension bike. It is a computer-based modeling process we developed in conjunction with CEIT (Centro de Estudios e Investigaciones Tecnológicas) that allows us to virtually test and fine-tune our suspension platforms. Using a vast database of shock tunes and component behaviors we can study a design under a simulated rider that exerts forces on the pedals, saddle and handlebars. We can shape the tests to evaluate different variables – rider height, weight, riding style – on different tracks. Even tire pressures can be tested and recorded before a welding torch is lit.

When the tires finally hit the dirt we can focus on fine-tuning damper characteristics and spring curves with our expert suspension partners. This is the obsessive tinkering that turns a good bike into a great one. There is a general perception that this is how other companies design their suspension bikes - this is not the case. Orbea's Advanced Dynamics testing database, compiled with an unusual degree of cooperation with our suspension partners, is unique in the industry.



## ASYMMETRY ERGONOMICS

The asymmetric/offset design offers unique advantages beyond stiffness and low weight. The shock is mounted in a position that offers incredibly easy access to damper controls, and without a frame support in the way, adjusting progressivity with volume spacers is easy to do right on

the bike. By offsetting the shock, the amount of vertical space required to fit the shock and frame support is reduced, leaving room for a tool kit and a 500ml bottle with easy left-side access. The top tube is lower for extremely low standover.



The 12mm offset of the shock allows the vertical distance taken up by the top tube, shock and frame reinforcement to be compressed. The top tube is lower for extremely low standover.

PURE ENDURO GEOMETRY

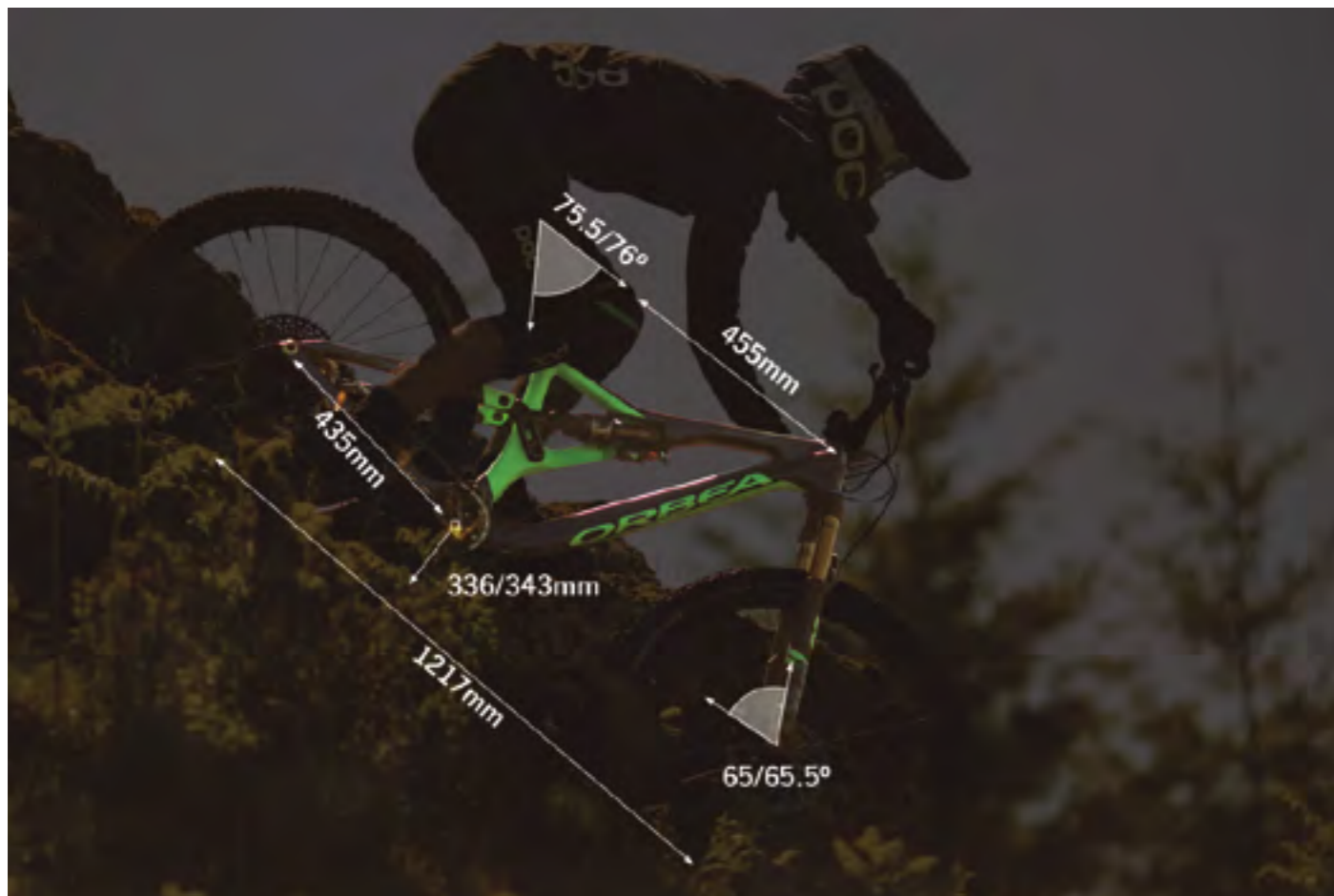

CONCENTRIC BOOST

Increasing rear axle spacing to 148mm over the 142mm standard moves the chainline outboard by 3mm, increasing the space available at the bottom bracket. This doesn't sound like much but means that tire clearance can be increased without sacrificing drivetrain clearance or swingarm rigidity. All of it adds up to more durability, nimble handling and a bike that tracks better through rough terrain.



*MyO*

# DESIGN YOUR FRAME

- 01 CHOOSE A MODEL AND SELECT OR SUBSTITUTE YOUR FAVORITE COMPONENTS.
- 02 CREATE A CUSTOM PAINT SCHEME.
- 03 ADD YOUR NAME TO THE TOPE TUBE.

[WWW.ORBEA.COM](http://WWW.ORBEA.COM)

# RALLON

SIZES	S/M-29"	LG-29"	XL-29"
1 - Seat Tube (C-T)	406	444	483
2 - Top Tube (EFF)	583	611	644
3 - Head Tube	100	110	125
4 - Chainstay	435	435	435
5 - BB Height	343/336	343/336	343/336
6 - BB Drop	28/35	28/35	28/35
7 - Wheelbase	1187	1217	1253
8 - Head Angle	65.5/65°	65.5/65°	65.5/65°
9 - Seat Angle	76	76	76
10 - Standover	737	767	781
11 - Reach	430	455	485
12 - Stack	615	624	637
13 - Fork Length	567,1	567,1	567,1

HEIGHT (cm)	HEIGHT (in)	SIZE
160-175	63.0"-68.9"	S/M
170-185	66.9"-72.8"	LG
180-198	70.9"-78.0"	XL

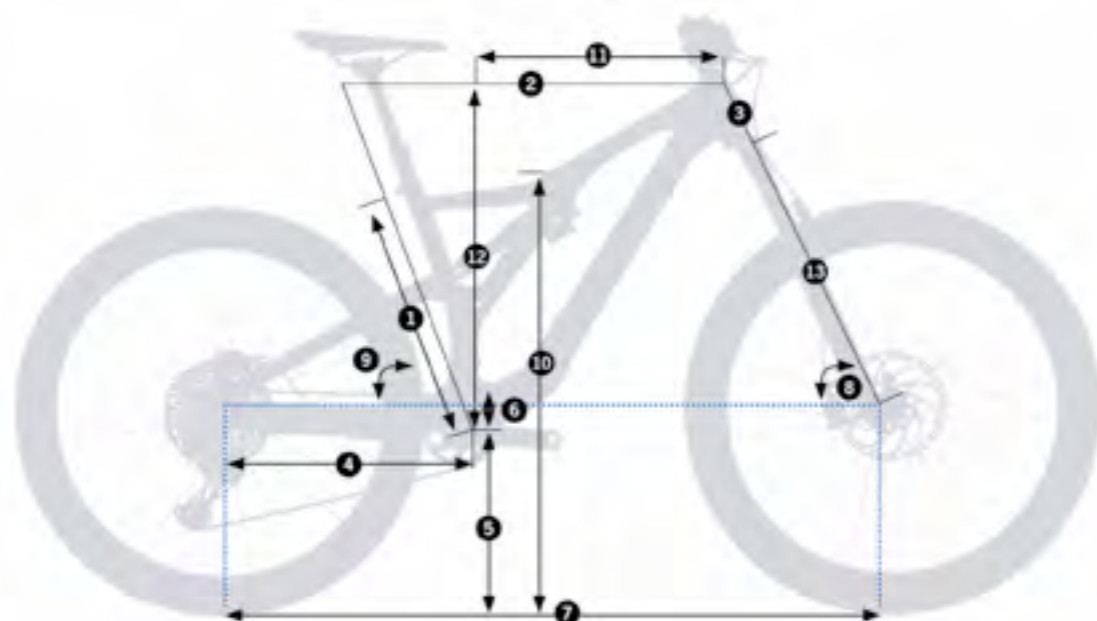

# RALLON M-LTD

Code	J275		
Size	Crank	Stem	Handlebar
S/M	170	32	800
LG	170	32	800
XL	170	50	800



<b>Frame</b>	Orbea Monocoque Race Carbon. Advanced Dynamics 150mm suspension technology. 29" wheels. Concentric Boost 12x148 rear axle. Pure Enduro geometry. Internal cable routing. ISCG05
<b>Shock</b>	Fox DHX2 Factory 2-Position Adjust SLS Spring Kashima 230x60mm Fox Float X2 Factory 2-Position Adjust Kashima custom tune 2
<b>Fork</b>	Fox 36 Float Factory 160 Grip2 RC2 QR15x110 Kashima
<b>Crankset</b>	SRAM XX1 Eagle Dub Black Boost 32t Rotor QX1 DM Sram 32t Chainring (EXTRA)



<b>Headset</b>	ACROS 1-1/8 - 1-1/2" Integrated
<b>Handlebar</b>	Race Face Next R 35 20mm Rise 800mm
<b>Stem</b>	Race Face Turbine R 35mm interface
<b>Shifters</b>	SRAM XX1 Eagle Gold
<b>Brakes</b>	Avid Code RSC Hydraulic Disc
<b>Rear Derailleur</b>	SRAM XX1 Eagle Gold
<b>Chain</b>	SRAM XX1 Eagle 12-Speed Gold
<b>Wheels</b>	ENVE M730 DT 240 TL 15/110mm (6-bolt) TL DT E-1501 Spline 30c TLR IS (6-bolt)
<b>Cassette</b>	SRAM XX1 XG-1299 Eagle 10-50t 12-Speed

<b>Tyres</b>	Maxxis Minion DHF 2.50" 60 TPI 3C Exo TLR
<b>Pedals</b>	N/A
<b>Seatpost</b>	Crank brothers Highline 31.6x425/150mm Race Face Aeffect Dropper 31.6x385/125mm Crank brothers Highline 31.6x465/170mm
<b>Saddle</b>	Selle Italia XR Trail Selle Italia X-LR Ti Flow
<b>Chainguide</b>	OneUp Components ISCG05 Guide

# RALLON M-TEAM

Code	J274		
Size	Crank	Stem	Handlebar
S/M	170	32	800
LG	170	32	800
XL	170	50	800



<b>Frame</b>	Orbea Monocoque Race Carbon. Advanced Dynamics 150mm suspension technology. 29" wheels. Concentric Boost 12x148 rear axle. Pure Enduro geometry. Internal cable routing. ISCG05
<b>Shock</b>	Fox DHX2 Factory 2-Position Adjust SLS Spring Kashima 230x60mm Fox DPX2 Factory 3-Position Adjust Evol Kashima 230x60mm
<b>Fork</b>	Fox 36 Float Factory 160 Grip2 RC2 QR15x110 Kashima
<b>Crankset</b>	SRAM Descendant Carbon Eagle Dub Boost 32t Rotor QX1 DM Sram 32t Chainring (EXTRA)



<b>Headset</b>	ACROS 1-1/8 - 1-1/2" Integrated
<b>Handlebar</b>	Race Face Next R 35 20mm Rise 800mm
<b>Stem</b>	Race Face Turbine R 35mm interface
<b>Shifters</b>	SRAM X01 Eagle
<b>Brakes</b>	Shimano XT M8020 Hydraulic disc SRAM Code RSC Hydraulic Disc
<b>Rear Derailleur</b>	SRAM X01 Eagle Gold
<b>Chain</b>	SRAM X01 Eagle 12-Speed
<b>Wheels</b>	DT E-1501 Spline 30c TLR 15/110mm IS (6-bolt) ENVE M730 DT 240 TL 15/110mm (6-bolt) TL
<b>Cassette</b>	SRAM GX XG-1275 Eagle 10-50t 12-Speed

<b>Tyres</b>	Maxxis Minion DHF 2.50" 60 TPI 3C Exo TLR
<b>Pedals</b>	N/A
<b>Seatpost</b>	Crank brothers Highline 31.6x425/150mm Race Face Aeffect Dropper 31.6x385/125mm Crank brothers Highline 31.6x465/170mm
<b>Saddle</b>	Selle Italia XR Trail Selle Italia X-LR Ti Flow
<b>Chainguide</b>	OneUp Components ISCG05 Guide

# RALLON M10



Code	J273		
<b>Size</b>	<b>Crank</b>	<b>Stem</b>	<b>Handlebar</b>
S/M	170	40	780
LG	170	40	780
XL	170	50	780



<b>Frame</b>	Orbea Monocoque Race Carbon. Advanced Dynamics 150mm suspension technology. 29" wheels. Concentric Boost 12x148 rear axle. Pure Enduro geometry. Internal cable routing. ISCG05
<b>Shock</b>	Fox DPX2 Factory 3-Position Adjust Evol Kashima custom tune 230x60mm Fox Float X2 Factory 2-Position Adjust Kashima custom tune 2
<b>Fork</b>	Fox DHX2 Factory 2-Position Adjust SLS Spring Kashima 230x60 Fox 36 Float Performance 160 3-Position QR15x110 Fox 36 Float Factory 160 Grip2 RC2 QR15x110 Kashima
<b>Crankset</b>	SRAM Descendant CNC Eagle Dub Boost 32t



<b>Headset</b>	ACROS 1-1/8 - 1-1/2" Integrated
<b>Handlebar</b>	Race Face Aeffect 35 20mm Rise 780mm
<b>Stem</b>	Race Face Aeffect R 35mm interface
<b>Shifters</b>	SRAM GX Eagle
<b>Brakes</b>	Shimano XT M8020 Hydraulic disc SRAM Code RSC Hydraulic Disc
<b>Rear Derailleur</b>	SRAM X01 Eagle Gold
<b>Chain</b>	SRAM GX Eagle 12-Speed
<b>Wheels</b>	DT E-1900 Spline 30c TLR 15/110mm IS (6-bolt) DT E-1501 Spline 30c TLR IS (6-bolt)

<b>Cassette</b>	SRAM GX XG-1275 Eagle 10-50t 12-Speed
<b>Tyres</b>	Maxxis Minion DHF 2.50" 60 TPI 3C Exo TLR
<b>Pedals</b>	N/A
<b>Seatpost</b>	Race Face Aeffect Dropper 31.6x385/125mm Crank brothers Highline 31.6x465/170mm Crank brothers Highline 31.6x425/150mm
<b>Saddle</b>	Selle Italia XR Trail Selle Italia X-LR Ti Flow



## TRAIL GETS BIGGER

Singletrack filled with rocks and roots. Loose climbs that take finesse to finish without walking. Steep, dark chutes through huge trees and over decaying logs. Ledgy switchbacks that you have only ridden that one time when you were in the zone. With all the buzz surrounding Enduro, e Bikes, Fat Bikes and wheel size, it's easy to forget that THIS is what mountain biking is all about. Escaping your daily routine to ride your bike anywhere, on any trail, until you can't ride any further. This is why you began and this is why you keep coming back. The new Occam celebrates this freedom and brings you to the places where it all started.

**OCCAM**



**OCCAM TR** >>  
SPEED AND EFFICIENCY

WHEEL SIZE  
**29"**  
TRAVEL  
**120mm**  
FORK TRAVEL  
**130mm**

GEOMETRY (L)  
CHAINSTAY:  
**435mm**  
REACH:  
**450mm**  
STACK:  
**615mm**

**OCCAM AM** >>  
FOR TECHNICAL DESCENTS

WHEEL SIZE  
**27.5"**  
TRAVEL  
**150mm**  
FORK TRAVEL  
**150mm**

GEOMETRY (L)  
CHAINSTAY:  
**425mm**  
REACH:  
**450mm**  
STACK:  
**604mm**

**OCCAM AM USER**

The Occcam AM combines 150 mm of travel with 27.5" wheels that give it a look that is a little bulkier. It is the perfect option for cyclists who prefer to have more travel and greater maneuverability. It's designed for technically complicated descents that require fast response and more travel. If you're looking to put a little more fun in your descents and you want a bicycle with sturdy specifications, your choice is the Occcam AM.

**OCCAM TR USER**

The Occcam TR, with 120 mm of rear travel and an increased fork travel of 130 mm, benefits from fast 29" wheels. If you like spending days on end on a bicycle seat and combining speed on your descents with surprising stability and lightness, the Occcam TR is made for you.

# OCCAM TECH



- 01 MONOCOQUE
- 02 ADVANCED DYNAMICS
- 03 UFO
- 04 BOOST



## MONOCOQUE

Occam uses sophisticated technology to bring you a simple experience. You won't find a dozen bearings or complex linkages driving a strange proprietary shock. Rather, you will discover a startlingly light, remarkably stiff and cleverly-engineered piece of technology designed to last a lifetime. We use the most technologically advanced

carbon construction available to make the most sophisticated frame possible – A complex and painstaking process with results you will appreciate on the trail. Prepreg carbon sheets are laser cut to minimize excess materials and overlap, and hours of premolding ensure optimal compaction with the smallest amount of carbon.



### ADVANCED DYNAMICS

Advanced Dynamics is not a design, but a development process. Our unique method transforms virtual models into real, highly-refined machines – Bikes for demanding riders that are faster, more fun to ride and far beyond ordinary.

The leverage ratio curve of the Occam is perfect for efficient trail riding. Sag can be set at 25-28% for smooth small bump compliance because the

leverage ratio decreases slightly for the first 40% of the shock stroke to offer great mid-stroke support. At approximately half travel, the ratio switches to a rising rate to counteract the progressive air spring, allowing full travel. Large impacts are easily handled by the custom tuning of the Fox dampers.

### UFO

We've done away with the pivot point at the rear axle. The flexible seat stay design creates an ultralight bike that requires little maintenance and offers stiffness and acceleration like you've never felt in a full suspension bike. The secret lies in the shape and materials that allow flex without approaching the critical deformation point. This technology, which has been long in use in F1 cars, delivers unrivaled weight-stiffness balance. UFO saves over 140g and results in a faster Occam.

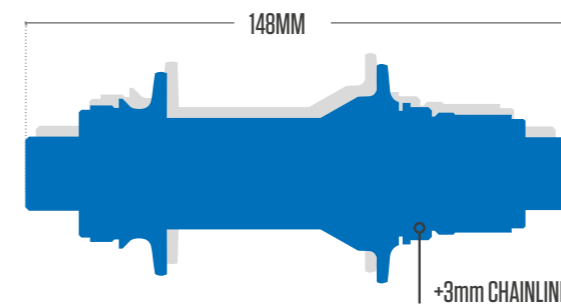

### BOOST

Occam TR is precise and responsive with 435mm chainstays and the excellent rigidity of a 12mm through-axle system. The Boost 148 standard widens rear axle spacing to 148mm which moves the chainline outboard by 3mm and increases the space available at the bottom bracket.





**OCCAM TR PLUS**  
DOUBLE DUTY 27,5"+ / 29"

Double Duty packs two bikes into one platform. Choose between 27+ and 29 wheel sizes in the same frame. Orbea Trail Geometry remains consistent since the outside diameter of both wheels is similar. 27+ tires are wider than traditional tires and are much higher volume, meaning they can be run at lower pressures. This allows Plus tires to go where regular tires can't, easily handling light mud and snow or sand, greatly expanding the terrain you can cover. Massively increased traction takes climbing grip to new levels and is also immediately apparent in fast corners when the fun starts.

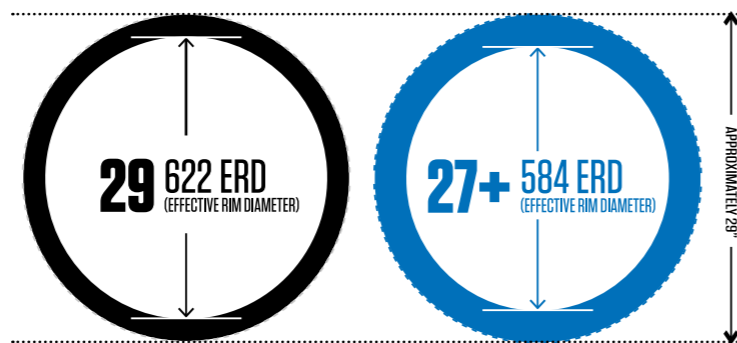

“FAST, AGILE AND FUN WITH THE LOOKS TO MATCH”.

RUSSEL BURTON, BIKERADAR

# OCCAM AM OMR

SIZES	S-27"	M-27"	L-27"
1 - Seat Tube (C-T)	393	432	470
2 - Top Tube (EFF)	563	590	612
3 - Head Tube	110	120	130
4 - Chainstay	425	425	425
5 - BB Height	342	342	342
6 - BB Drop	13	13	13
7 - Wheelbase	1121	1149	1173
8 - Head Angle	66.5°	66.5°	66.5°
9 - Seat Angle	74.5°	74.5°	74.5°
10 - Standover	713	741	768
11 - Reach	406	431	450
12 - Stack	585	595	604
13 - Fork Length	539,1	539,1	539,1

HEIGHT (cm)	HEIGHT (in)	SIZE
150-165	59.1"-65.0"	S
160-175	63.0"-68.9"	M
170-185	66.9"-72.8"	L



Red-Black (Gloss)  
M5



Mint/Dark-Mint (Gloss)  
M6

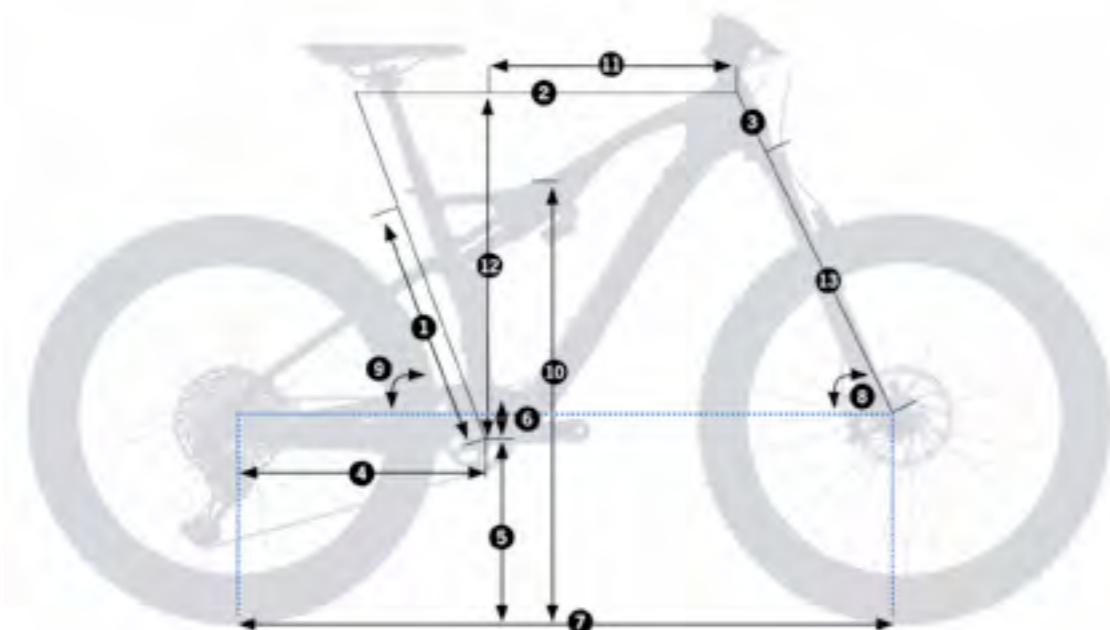

# OCCAM AM M-LTD *MyO*

Code	J261		
Size	Crank	Stem	Handlebar
S	170	50	780
M	175	50	780
L	175	70	780



<b>Frame</b>	Orbea Occam AM OMR 150mm travel UFO 27.5 Boost 12x148 PF
<b>Shock</b>	Fox DPX2 Factory 3-Position Adjust Evol Kashima custom tune 210x55mm
<b>Fork</b>	Fox 34 Float Factory 150 FIT4 3-Pos-Adj QR15x110 Kashima
<b>Crankset</b>	SRAM XX1 Eagle Dub Black Boost 32t Rotor QX1 DM Sram 32t Chainring (EXTRA)
<b>Headset</b>	ACROS 1-1/8 - 1-1/2" Integrated
<b>Handlebar</b>	Race Face Next R 35 20mm Rise 780mm
<b>Stem</b>	Race Face Turbine 35mm interface
<b>Shifters</b>	SRAM X01 Eagle
<b>Brakes</b>	Avid Guide RSC Hydraulic Disc Shimano XTR M9120 Hydraulic Disc



<b>Rear Derailleur</b>	SRAM XX1 Eagle Gold
<b>Chain</b>	SRAM XX1 Eagle 12-Speed Gold
<b>Wheels</b>	DT XMC-1200 Spline 30c TLR 15/110mm IS (6-bolt)
<b>Cassette</b>	SRAM XX1 XG-1299 Eagle 10-50t 12-Speed
<b>Tyres</b>	Maxxis Ardent 2,40" TLR 60 Tpi Exo Dual
<b>Pedals</b>	N/A
<b>Seatpost</b>	Crank brothers Highline 31.6x425/150mm
<b>Saddle</b>	Selle Italia XR Trail Selle Italia X-LR Ti Flow
<b>Chainguide</b>	OneUp Components ISCG05 Guide

# OCCAM AM M10 *MyO*

Code	J260		
Size	Crank	Stem	Handlebar
S	170	50	760
M	175	50	760
L	175	70	760



<b>Frame</b>	Orbea Occam AM OMR 150mm travel UFO 27.5 Boost 12x148 PF
<b>Shock</b>	Fox DPX2 Factory 3-Position Adjust Evol Kashima custom tune 210x55mm
<b>Fork</b>	Fox 34 Float Factory 150 FIT4 3-Pos-Adj QR15x110 Kashima
<b>Crankset</b>	SRAM Descendant Carbon Eagle Dub Boost 32t Rotor QX1 DM Sram 32t Chainring (EXTRA)
<b>Headset</b>	ACROS 1-1/8 - 1-1/2" Integrated
<b>Handlebar</b>	Race Face Aeffect 35 20mm Riser 760mm Race Face Next 35 Riser 20/780mm+Turbine 35 Kit (B)
<b>Stem</b>	Race Face Aeffect 35mm interface
<b>Shifters</b>	SRAM GX Eagle

<b>Brakes</b>	Shimano XT M8000 Hydraulic Disc SRAM Guide RSC Hydraulic Disc
<b>Rear Derailleur</b>	SRAM X01 Eagle Gold
<b>Chain</b>	SRAM GX Eagle 12-Speed
<b>Wheels</b>	DT M-1900 Spline 30c TLR 15/110mm CL DT XMC-1200 Spline 30c TLR 15/110mm IS (6-bolt)
<b>Cassette</b>	SRAM GX XG-1275 Eagle 10-50t 12-Speed
<b>Tyres</b>	Maxxis Ardent 2,40" TLR 60 Tpi Exo Dual
<b>Pedals</b>	N/A
<b>Seatpost</b>	Race Face Aeffect Dropper 31.6x385/125mm Crank brothers Highline 31,6x425/150mm
<b>Saddle</b>	Selle Italia XR Trail Selle Italia X-LR Ti Flow



# OCCAM AM M30



Code	J259		
Size	Crank	Stem	Handlebar
S	170	60	760
M	175	60	760
L	175	70	760



<b>Frame</b>	Orbea Occam AM OMR 150mm travel UFO 27.5 Boost 12x148 PF
<b>Shock</b>	Fox Float DPS Performance 3-Position Evol custom tune 210x55mm
	Fox DPX2 Factory 3-Pos Adjust Evol Kashima 210x55mm
<b>Fork</b>	Fox 34 Float Performance 150 3-Position QR15x110
	Fox 34 Float Factory 150 FIT4 3-Pos-Adj QR15x110 K
<b>Crankset</b>	SRAM Descendant CNC Eagle Dub Boost 32t
	Rotor QX1 DM Sram 32t Chainring (EXTRA)
<b>Headset</b>	ACROS 1-1/8 - 1-1/2" Integrated
<b>Handlebar</b>	Orbea OC-II Riser 760mm

	Race Face Aeffect35 Riser 20/760mm+Aeffect R35 Kit
<b>Stem</b>	Race Face Ride
<b>Shifters</b>	SRAM NX Eagle
<b>Brakes</b>	Shimano MT501 BR500 Hydraulic Disc
	Shimano XT M8000 Hydraulic Disc
<b>Rear Derailleur</b>	SRAM NX Eagle
<b>Chain</b>	SRAM NX Eagle 12-Speed
<b>Wheels</b>	DT M-1900 Spline 30c TLR 15/110mm CL
<b>Cassette</b>	SRAM NX PG-1230 Eagle 11-50t 12-Speed
<b>Tyres</b>	Maxxis Ardent 2,40" TLR 60 Tpi Exo Dual
<b>Pedals</b>	N/A
<b>Seatpost</b>	Race Face Aeffect Dropper 31.6x385/125mm
	Crank brothers Highline 31,6x425/150mm

<b>Saddle</b>	Selle Italia XR Trail
	Selle Italia X-LR Ti Flow

# OCCAM AM HYDRO

SIZES	S-27"	M-27"	L-27"	XL-27"
1 - Seat Tube (C-T)	400	432	470	520
2 - Top Tube (EFF)	563	590	612	637
3 - Head Tube	110	120	130	145
4 - Chainstay	425	425	425	425
5 - BB Height	342	342	342	342
6 - BB Drop	13	13	13	13
7 - Wheelbase	1121	1149	1173	1200
8 - Head Angle	66.5°	66.5°	66.5°	66.5°
9 - Seat Angle	74.5°	74.5°	74.5°	74.5°
10 - Standover	713	741	768	785
11 - Reach	406	431	450	472
12 - Stack	585	595	604	617
13 - Fork Length	539,1	539,1	539,1	539,1

HEIGHT (cm)	HEIGHT (in)	SIZE
150-165	59.1"-65.0"	S
160-175	63.0"-68.9"	M
170-185	66.9"-72.8"	L
180-198	70.9"-78.0"	XL

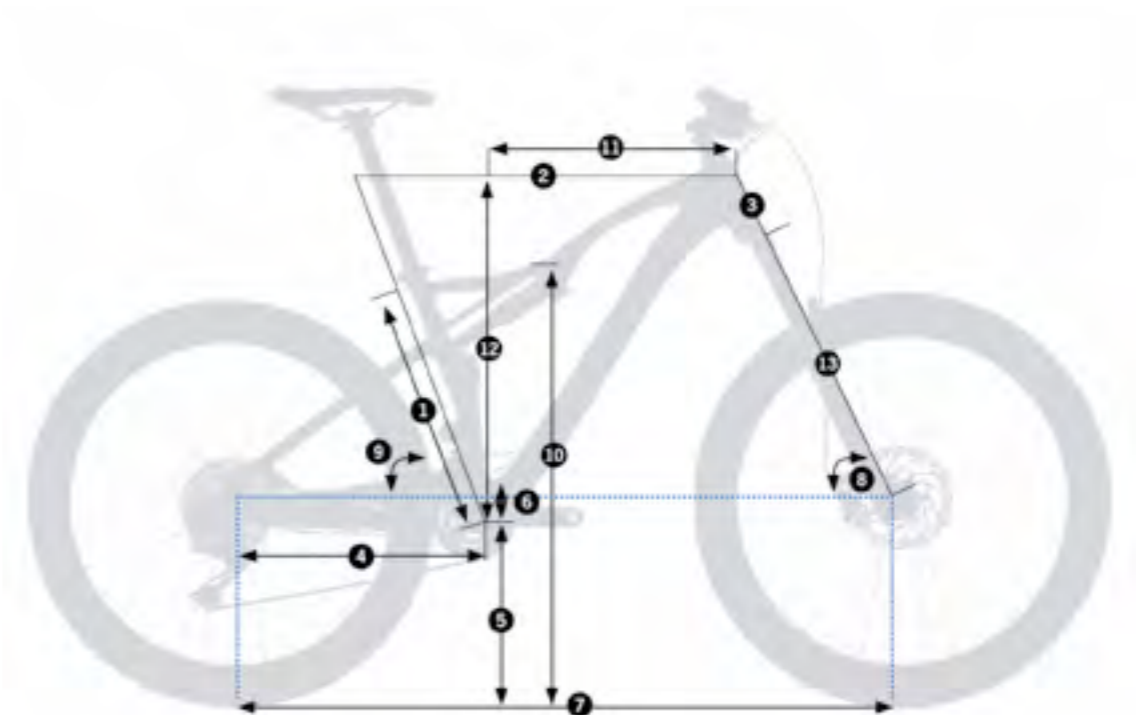
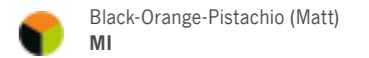
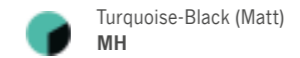

## OCCAM AM H10

MyO<sub>2.0</sub>

Code	J258		
Size	Crank	Stem	Handlebar
S	170	50	760
M	175	50	760
L	175	50	760
XL	175	50	760



<b>Frame</b>	Orbea Occam AM 2018 Hydro Triple Butted 150mm travel 27.5 C-Boost 12x148 PF
<b>Shock</b>	Fox Float DPS Performance 3-Position Evol custom tune 210x55mm Fox DPX2 Factory 3-Pos Adjust Evol Kashima 210x55mm
<b>Fork</b>	Fox 34 Float Performance 150 3-Position QR15x110 Fox 34 Float Factory 150 FIT4 3-Pos-Adj QR15x110 Kashima
<b>Crankset</b>	SRAM Descendant CNC Eagle Dub Boost 32t Rotor QX1 DM Sram 32t Chainring (EXTRA)
<b>Headset</b>	ACROS 1-1/8 - 1-1/2" Integrated
<b>Handlebar</b>	Race Face Aeffect 35 20mm Riser 760mm

	Race Face Next 35 Riser 20/780mm+Tur-bine 35 Kit (B)
<b>Stem</b>	Race Face Aeffect R 35mm interface
<b>Shifters</b>	SRAM GX Eagle
<b>Brakes</b>	Shimano MT501 BR500 Hydraulic Disc Shimano XT M8000 Hydraulic Disc
<b>Rear Derailleur</b>	SRAM GX Eagle
<b>Chain</b>	SRAM GX Eagle 12-Speed
<b>Wheels</b>	DT M-1900 Spline 30c TLR 15/110mm CL
<b>Cassette</b>	SRAM GX XG-1275 Eagle 10-50t 12-Speed
<b>Tyres</b>	Maxxis Ardent 2,40" TLR 60 Tpi Exo Dual
<b>Pedals</b>	N/A
<b>Seatpost</b>	Race Face Aeffect Dropper 31.6x385/125mm Crank brothers Highline 31,6x425/150mm

<b>Saddle</b>	Selle Italia XR Trail Selle Italia X-LR Ti Flow
---------------	--

## OCCAM AM H30

MyO<sub>2.0</sub>

Code	J257		
Size	Crank	Stem	Handlebar
S	170	60	760
M	175	60	760
L	175	70	760
XL	175	70	760



<b>Frame</b>	Orbea Occam AM 2018 Hydro Triple Butted 150mm travel 27.5 C-Boost 12x148 PF
<b>Shock</b>	Fox Float DPS Performance 3-Position Evol custom tune 210x55mm Fox DPX2 Factory 3-Pos Adjust Evol Kashima 210x55mm
<b>Fork</b>	Fox 34 Float Performance 150 3-Position QR15x110 Fox 34 Float Factory 150 FIT4 3-Pos-Adj QR15x110 Kashima
<b>Crankset</b>	SRAM Descendant CNC Eagle Dub Boost 32t Rotor QX1 DM Sram 32t Chainring (EXTRA)
<b>Headset</b>	ACROS 1-1/8 - 1-1/2" Integrated
<b>Handlebar</b>	Orbea OC-II Riser 760mm

	Race Face Aeffect35 Riser 20/760mm+Ae-ffect R35 Kit
<b>Stem</b>	Race Face Ride
<b>Shifters</b>	SRAM NX Eagle
<b>Brakes</b>	Shimano MT501 BR500 Hydraulic Disc Shimano XT M8000 Hydraulic Disc
<b>Rear Derailleur</b>	SRAM NX Eagle
<b>Chain</b>	SRAM NX Eagle 12-Speed
<b>Wheels</b>	Mach1 Klixx 23c Tubeless Ready DT M-1900 Spline 30c TLR 15/110mm CL(Maxxis Ikon TLR includ)
<b>Cassette</b>	SRAM NX PG-1230 Eagle 11-50t 12-Speed
<b>Tyres</b>	Maxxis High Roller II 2.40" FB 60 TPI Exo Maxxis High Roller II 2.40"TLR(Front)/Ardent 2,40"

<b>Pedals</b>	N/A
<b>Seatpost</b>	Race Face Aeffect Dropper 31.6x385/125mm Crank brothers Highline 31,6x425/150mm
<b>Saddle</b>	Selle Royal Custom Trail II 2043 HRN Selle Italia XR Trail

## OCCAM AM H50

MyO<sub>2.0</sub>

Code	J256		
Size	Crank	Stem	Handlebar
S	170	60	760
M	175	60	760
L	175	70	760
XL	175	70	760



<b>Frame</b>	Orbea Occam AM 2018 Hydro Triple Butted 150mm travel 27.5 C-Boost 12x148 PF
<b>Shock</b>	Fox Float DPS Performance 3-Position Evol custom tune 210x55mm Fox DPX2 Factory 3-Pos Adjust Evol Kashima 210x55mm
<b>Fork</b>	RockShox Recon RL 150 Air Q15x110 Boost Fox 34 Float Performance 150 3-Position QR15x110
<b>Crankset</b>	Prowheel Claw-551-TT-Boost 26x36t Race Face Aeffect Cinch 32t (11-46T Cass)
<b>Headset</b>	FSA 1-1/8 - 1-1/2" Integrated
<b>Handlebar</b>	Orbea OC-II Riser 760mm Race Face Aeffect35 Riser 20/760mm+Ae-ffect R35 Kit

<b>Stem</b>	Orbea OC-II
<b>Shifters</b>	Shimano SLX M7000
<b>Brakes</b>	Shimano MT201 Hydraulic Disc Shimano MT501 BR500 Hydraulic Disc
<b>Rear Derailleur</b>	Shimano XT M8000 GS Shadow Plus Direct Mount
<b>Front Derailleur</b>	Shimano SLX M7020 Direct mount
<b>Chain</b>	Shimano HG601-11
<b>Wheels</b>	Mach1 Klixx 23c Tubeless Ready DT M-1900 Spline 30c TLR 15/110mm CL(Maxxis Ikon TLR includ)
<b>Cassette</b>	Sun Race 11-42t 11-Speed
<b>Tyres</b>	Maxxis High Roller II 2.40" FB 60 TPI Exo Maxxis High Roller II 2.40"TLR(Front)/Ardent 2,40"

<b>Pedals</b>	N/A
<b>Seatpost</b>	Orbea Digit 31.6x400mm Race Face Aeffect Dropper 31.6x385/125mm
<b>Saddle</b>	Selle Royal Custom Trail II 2043 HRN Selle Italia XR Trail

## OCCAM TR OMR

SIZES	S-29"	M-29"	L-29"	XL-29"
1 - Seat Tube (C-T)	393	432	470	520
2 - Top Tube (EFF)	572	599	621	647
3 - Head Tube	105	115	125	140
4 - Chainstay	435	435	435	435
5 - BB Height	342	342	342	342
6 - BB Drop	33	33	33	33
7 - Wheelbase	1122	1150	1173	1201
8 - Head Angle	67.5°	67.5°	67.5°	67.5°
9 - Seat Angle	74°	74°	74°	74°
10 - Standover	725	743	769	782
11 - Reach	406	431	450	472
12 - Stack	596	606	615	629
13 - Fork Length	537,1	537,1	537,1	537,1

HEIGHT (cm)	HEIGHT (in)	SIZE
150-165	59.1"-65.0"	S
160-175	63.0"-68.9"	M
170-185	66.9"-72.8"	L
180-198	70.9"-78.0"	XL



Red-Black (Gloss)  
M5



Black-Mint (Matt-Gloss)  
M7

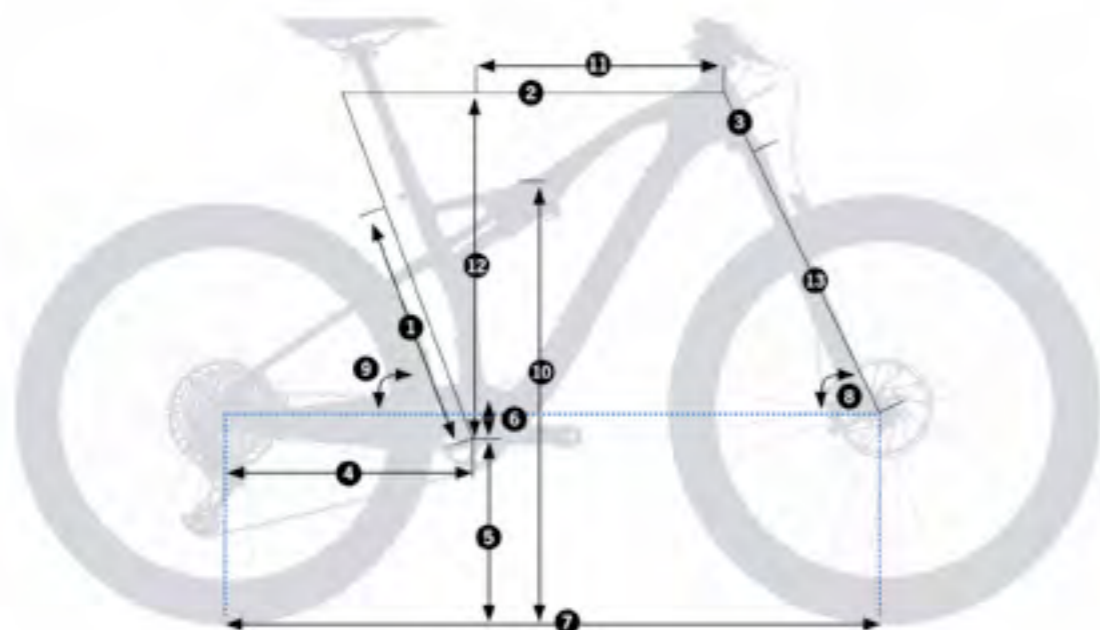

## OCCAM TR M-LTD *MyO*

Code	J269		
Size	Crank	Stem	Handlebar
S	170	50	760
M	175	50	760
L	175	70	760
XL	175	70	760



<b>Frame</b>	Orbea Occam TR 2018 OMR 120mm travel UFO 29/27.5+ Boost 12x148 PF
<b>Shock</b>	Fox Float DPS Factory 3-Position Adjust Evol Kashima custom tune 184x44mm
<b>Fork</b>	Fox 34 Float Factory 130 FIT4 3-Pos-Adj QR15x110 Kashima
<b>Crankset</b>	SRAM XX1 Eagle Dub Black Boost 32t Rotor QX1 DM Sram 32t Chainring (EXTRA)
<b>Headset</b>	ACROS 1-1/8 - 1-1/2" Integrated
<b>Handlebar</b>	Race Face Next 35 10mm Rise 780mm
<b>Stem</b>	Race Face Turbine 35mm interface
<b>Shifters</b>	SRAM X01 Eagle
<b>Brakes</b>	Avid Guide RSC Hydraulic Disc Shimano XTR M9120 Hydraulic Disc



<b>Rear Derailleur</b>	SRAM XX1 Eagle Gold
<b>Chain</b>	SRAM XX1 Eagle 12-Speed Gold
<b>Wheels</b>	DT XRC-1200 Spline 25c TLR 15/110mm IS (6-bolt)
<b>Cassette</b>	SRAM XX1 XG-1299 Eagle 10-50t 12-Speed
<b>Tyres</b>	Maxxis Ardent 2,4" TLR Exo Dual
<b>Pedals</b>	N/A
<b>Seatpost</b>	Crank brothers Highline 31.6x425/150mm
<b>Saddle</b>	Selle Italia XR Trail Selle Italia X-LR Ti Flow
<b>Chainguide</b>	OneUp Components ISCG05 Guide

## OCCAM TR M10 *MyO*

Code	J268		
Size	Crank	Stem	Handlebar
S	170	50	760
M	175	50	760
L	175	50	760
XL	175	50	760



<b>Frame</b>	Orbea Occam TR 2018 OMR 120mm travel UFO 29/27.5+ Boost 12x148 PF
<b>Shock</b>	Fox Float DPS Factory 3-Position Adjust Evol Kashima custom tune 184x44mm
<b>Fork</b>	Fox 34 Float Factory 130 FIT4 3-Pos-Adj QR15x110 Kashima
<b>Crankset</b>	SRAM Descendant Carbon Eagle Dub Boost 32t Rotor QX1 DM Sram 32t Chainring (EXTRA)
<b>Headset</b>	ACROS 1-1/8 - 1-1/2" Integrated
<b>Handlebar</b>	Race Face Aeffect 35 10mm Rise 760mm Race Face Next 35 Riser 10/760mm+Turbine 35 Kit (Bar+Stem)
<b>Stem</b>	Race Face Aeffect R 35mm interface
<b>Shifters</b>	SRAM GX Eagle

<b>Brakes</b>	Shimano XT M8000 Hydraulic Disc SRAM Guide RSC Hydraulic Disc
<b>Rear Derailleur</b>	SRAM X01 Eagle Gold
<b>Chain</b>	SRAM GX Eagle 12-Speed
<b>Wheels</b>	DT M-1900 Spline 25c TLR 15/110mm CL DT XRC-1200 Spline 25c TLR 15/110mm IS (6-bolt)
<b>Cassette</b>	SRAM GX XG-1275 Eagle 10-50t 12-Speed
<b>Tyres</b>	Maxxis Ardent 2,4" TLR Exo Dual
<b>Pedals</b>	N/A
<b>Seatpost</b>	Race Face Aeffect Dropper 31.6x385/125mm Crank brothers Highline 31,6x425/150mm
<b>Saddle</b>	Selle Italia XR Trail Selle Italia X-LR Ti Flow



## OCCAM TR M20 PLUS *MyO<sub>2.0</sub>*

Code	J267		
<b>Size</b>	<b>Crank</b>	<b>Stem</b>	<b>Handlebar</b>
S	170	50	760
M	175	50	760
L	175	50	760
XL	175	50	760



<b>Frame</b>	Orbea Occam TR 2018 OMR 120mm travel UFO 29/27.5+ Boost 12x148 PF
<b>Shock</b>	Fox Float DPS Performance 3-Position Evol custom tune 184x44mm Fox Float DPS Factory 3-Pos Adjust Evol Kashima 184x44mm
<b>Fork</b>	Fox 34 Float Performance 130 3-Position QR15x110 Fox 34 Float Factory 130 FIT4 3-Pos-Adj QR15x110 Kashima
<b>Crankset</b>	SRAM Descendant CNC Eagle Dub Boost 32t Rotor QX1 DM Sram 32t Chainring (EXTRA)
<b>Headset</b>	ACROS 1-1/8 - 1-1/2" Integrated
<b>Handlebar</b>	Race Face Aeffect 35 10mm Rise 760mm

<b>Stem</b>	Race Face Next 35 Riser 10/760mm+Turbine 35 Kit (Bar+Stem)
<b>Shifters</b>	SRAM GX Eagle
<b>Brakes</b>	Shimano XT M8000 Hydraulic Disc SRAM Guide RSC Hydraulic Disc
<b>Rear Derailleur</b>	SRAM X01 Eagle Gold
<b>Chain</b>	SRAM GX Eagle 12-Speed
<b>Wheels</b>	DT M-1900 Spline 35c TLR 15/110mm CL
<b>Cassette</b>	SRAM GX XG-1275 Eagle 10-50t 12-Speed
<b>Tyres</b>	Maxxis High Roller II 3.00" 60 TPI Exo TLR
<b>Pedals</b>	N/A
<b>Seatpost</b>	Race Face Aeffect Dropper 31.6x385/125mm Crank brothers Highline 31,6x425/150mm

<b>Saddle</b>	Selle Italia XR Trail Selle Italia X-LR Ti Flow
---------------	--

## OCCAM TR M30 *MyO<sub>2.0</sub>*

Code	J266		
<b>Size</b>	<b>Crank</b>	<b>Stem</b>	<b>Handlebar</b>
S	170	60	760
M	175	60	760
L	175	70	760
XL	175	70	760



<b>Frame</b>	Orbea Occam TR 2018 OMR 120mm travel UFO 29/27.5+ Boost 12x148 PF
<b>Shock</b>	Fox Float DPS Performance 3-Position Evol custom tune 184x44mm Fox Float DPS Factory 3-Pos Adjust Evol Kashima 184x44mm
<b>Fork</b>	Fox 34 Float Performance 130 3-Position QR15x110 Fox 34 Float Factory 130 FIT4 3-Pos-Adj QR15x110 Kashima
<b>Crankset</b>	SRAM Descendant CNC Eagle Dub Boost 32t Rotor QX1 DM Sram 32t Chainring (EXTRA)
<b>Headset</b>	ACROS 1-1/8 - 1-1/2" Integrated
<b>Handlebar</b>	Orbea OC-II Flat 760mm

<b>Stem</b>	Race Face Aeffect35 Riser 10/760mm+Aeffect R35 Kit(Bar+Stem)
<b>Shifters</b>	SRAM NX Eagle
<b>Brakes</b>	Shimano MT501 BR500 Hydraulic Disc Shimano XT M8000 Hydraulic Disc
<b>Rear Derailleur</b>	SRAM NX Eagle
<b>Chain</b>	SRAM NX Eagle 12-Speed
<b>Wheels</b>	DT M-1900 Spline 25c TLR 15/110mm CL
<b>Cassette</b>	SRAM NX PG-1230 Eagle 11-50t 12-Speed
<b>Tyres</b>	Maxxis Ardent 2,4" TLR Exo Dual
<b>Pedals</b>	N/A
<b>Seatpost</b>	Race Face Aeffect Dropper 31.6x385/125mm Crank brothers Highline 31,6x425/150mm

<b>Saddle</b>	Selle Italia XR Trail Selle Italia X-LR Ti Flow
---------------	--

## OCCAM TR HYDRO

SIZES	S-29"	M-29"	L-29"	XL-29"
1 - Seat Tube (C-T)	393	432	470	520
2 - Top Tube (EFF)	572	599	621	647
3 - Head Tube	105	115	125	140
4 - Chainstay	435	435	435	435
5 - BB Height	342	342	342	342
6 - BB Drop	33	33	33	33
7 - Wheelbase	1122	1150	1173	1201
8 - Head Angle	67.5°	67.5°	67.5°	67.5°
9 - Seat Angle	74°	74°	74°	74°
10 - Standover	725	743	769	782
11 - Reach	406	431	450	472
12 - Stack	596	606	615	629
13 - Fork Length	537,1	537,1	537,1	537,1

HEIGHT (cm)	HEIGHT (in)	SIZE
150-165	59.1"-65.0"	S
160-175	63.0"-68.9"	M
170-185	66.9"-72.8"	L
180-198	70.9"-78.0"	XL



Black (Matte-Gloss)  
MK



Orange-Black (Gloss)  
ML

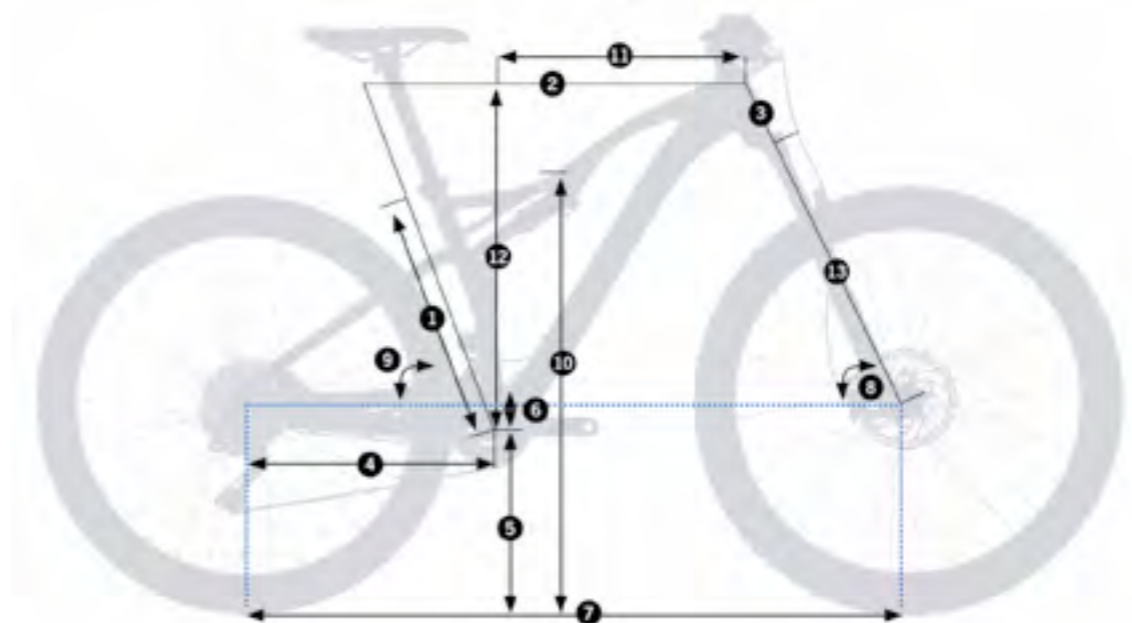

## OCCAM TR H10

MyO<sub>2.0</sub>

Code	J265		
Size	Crank	Stem	Handlebar
S	170	50	760
M	175	50	760
L	175	50	760
XL	175	50	760



<b>Frame</b>	Orbea Occam TR 2018 Hydro Triple Butted 120mm travel 29/27.5+ C-Boost 12x148 PF
<b>Shock</b>	Fox Float DPS Performance 3-Position Evol custom tune 184x44mm Fox Float DPS Factory 3-Pos Adjust Evol Kashima 184x44mm
<b>Fork</b>	Fox 34 Float Performance 130 3-Position QR15x110 Fox 34 Float Factory 130 FIT4 3-Pos-Adj QR15x110 Kashima
<b>Crankset</b>	SRAM Descendant CNC Eagle Dub Boost 32t Rotor QX1 DM Sram 32t Chainring (EXTRA)
<b>Headset</b>	ACROS 1-1/8 - 1-1/2" Integrated
<b>Handlebar</b>	Race Face Aeffect 35 10mm Rise 760mm

<b>Stem</b>	Race Face Next 35 Riser 10/760mm+Turbine 35 Kit (Bar+Stem)
<b>Shifters</b>	Race Face Aeffect R 35mm interface
<b>Shifters</b>	SRAM GX Eagle
<b>Brakes</b>	Shimano MT501 BR500 Hydraulic Disc Shimano XT M8000 Hydraulic Disc
<b>Rear Derailleur</b>	SRAM GX Eagle
<b>Chain</b>	SRAM GX Eagle 12-Speed
<b>Wheels</b>	DT M-1900 Spline 25c TLR 15/110mm CL
<b>Cassette</b>	SRAM GX XG-1275 Eagle 10-50t 12-Speed
<b>Tyres</b>	Maxxis Ardent 2,4" TLR Exo Dual
<b>Pedals</b>	N/A
<b>Seatpost</b>	Race Face Aeffect Dropper 31.6x385/125mm Crank brothers Highline 31,6x425/150mm

<b>Saddle</b>	Selle Italia XR Trail Selle Italia X-LR Ti Flow
---------------	--

## OCCAM TR H20 PLU

MyO<sub>2.0</sub>

Code	J264		
Size	Crank	Stem	Handlebar
S	170	50	760
M	175	50	760
L	175	50	760
XL	175	50	760



<b>Frame</b>	Orbea Occam TR 2018 Hydro Triple Butted 120mm travel 29/27.5+ C-Boost 12x148 PF
<b>Shock</b>	Fox Float DPS Performance 3-Position Evol custom tune 184x44mm Fox Float DPS Factory 3-Pos Adjust Evol Kashima 184x44mm
<b>Fork</b>	Fox 34 Float Performance 130 3-Position QR15x110 Fox 34 Float Factory 130 FIT4 3-Pos-Adj QR15x110 Kashima
<b>Crankset</b>	SRAM Descendant CNC Eagle Dub Boost 32t Rotor QX1 DM Sram 32t Chainring (EXTRA)
<b>Headset</b>	ACROS 1-1/8 - 1-1/2" Integrated
<b>Handlebar</b>	Race Face Aeffect 35 10mm Rise 760mm

<b>Stem</b>	Race Face Next 35 Riser 10/760mm+Turbine 35 Kit (Bar+Stem)
<b>Shifters</b>	Race Face Aeffect R 35mm interface
<b>Shifters</b>	SRAM NX Eagle
<b>Brakes</b>	Shimano MT501 BR500 Hydraulic Disc Shimano XT M8000 Hydraulic Disc
<b>Rear Derailleur</b>	SRAM NX Eagle
<b>Chain</b>	SRAM NX Eagle 12-Speed
<b>Cassette</b>	SRAM NX PG-1230 Eagle 11-50t 12-Speed
<b>Tyres</b>	Maxxis High Roller II 3.00" 60 TPI Exo TLR
<b>Pedals</b>	N/A
<b>Seatpost</b>	Race Face Aeffect Dropper 31.6x385/125mm Crank brothers Highline 31,6x425/150mm
<b>Saddle</b>	Selle Royal Custom Trail II 2043 HRN

<b>Saddle</b>	Selle Italia XR Trail
---------------	-----------------------

## OCCAM TR H30

MyO<sub>2.0</sub>

Code	J263		
Size	Crank	Stem	Handlebar
S	170	60	760
M	175	60	760
L	175	70	760
XL	175	70	760



<b>Frame</b>	Orbea Occam TR 2018 Hydro Triple Butted 120mm travel 29/27.5+ C-Boost 12x148 PF
<b>Shock</b>	Fox Float DPS Performance 3-Position Evol custom tune 184x44mm Fox Float DPS Factory 3-Pos Adjust Evol Kashima 184x44mm
<b>Fork</b>	Fox 34 Float Performance 130 3-Position QR15x110 Fox 34 Float Factory 130 FIT4 3-Pos-Adj QR15x110 Kashima
<b>Crankset</b>	SRAM Descendant CNC Eagle Dub Boost 32t Rotor QX1 DM Sram 32t Chainring (EXTRA)
<b>Headset</b>	ACROS 1-1/8 - 1-1/2" Integrated
<b>Handlebar</b>	Orbea OC-II Flat 760mm

<b>Stem</b>	Race Face Aeffect35 Riser 10/760mm+Aeffect R35 Kit(Bar+Stem)
<b>Shifters</b>	Race Face Ride
<b>Shifters</b>	SRAM NX Eagle
<b>Brakes</b>	Shimano MT501 BR500 Hydraulic Disc Shimano XT M8000 Hydraulic Disc
<b>Rear Derailleur</b>	SRAM NX Eagle
<b>Chain</b>	SRAM NX Eagle 12-Speed
<b>Wheels</b>	Mach1 Klixx 23c Tubeless Ready DT M-1900 Spline 25c TLR 15/110mm CL+Maxxis TLR Tires
<b>Cassette</b>	SRAM NX PG-1230 Eagle 11-50t 12-Speed
<b>Tyres</b>	Maxxis Ardent 2,40" FB 60 Tpi Exo Maxxis Ardent 2,40"TLR(Front)/Forekaster 2,35"TLR(Rear)

<b>Pedals</b>	N/A
<b>Seatpost</b>	Race Face Aeffect Dropper 31.6x385/125mm Crank brothers Highline 31,6x425/150mm
<b>Saddle</b>	Selle Royal Custom Trail II 2043 HRN Selle Italia XR Trail

## OCCAM TR H50

MyO<sub>2.0</sub>

Code	J262		
Size	Crank	Stem	Handlebar
S	170	60	760
M	175	60	760
L	175	70	760
XL	175	70	760



<b>Frame</b>	Orbea Occam TR 2018 Hydro Triple Butted 120mm travel 29/27.5+ C-Boost 12x148 PF
<b>Shock</b>	Fox Float DPS Performance 3-Position Evol custom tune 184x44mm Fox Float DPS Factory 3-Pos Adjust Evol Kashima 184x44mm
<b>Fork</b>	RockShox Recon RL 130 Air Q15x110 Boost Fox 34 Float Performance 130 3-Position QR15x110
<b>Crankset</b>	Prowheel Claw-551-TT-Boost 26x36t Race Face Aeffect Cinch 32t (11-46T Cass)
<b>Headset</b>	FSA 1-1/8 - 1-1/2" Integrated
<b>Handlebar</b>	Orbea OC-II Flat 760mm

<b>Stem</b>	Race Face Aeffect35 Riser 10/760mm+Aeffect R35 Kit(Bar+Stem)
<b>Stem</b>	Orbea OC-II
<b>Shifters</b>	Shimano SLX M7000
<b>Brakes</b>	Shimano MT201 Hydraulic Disc Shimano MT501 BR500 Hydraulic Disc
<b>Rear Derailleur</b>	Shimano XT M8000 GS Shadow Plus Direct Mount
<b>Front Derailleur</b>	Shimano SLX M7020 Direct mount
<b>Chain</b>	Shimano HG601-11
<b>Wheels</b>	Mach1 Klixx 23c Tubeless Ready DT M-1900 Spline 25c TLR 15/110mm CL+Maxxis TLR Tires
<b>Cassette</b>	Sun Race 11-42t 11-Speed
<b>Tyres</b>	Maxxis Ardent 2,40" FB 60 Tpi Exo

<b>Pedals</b>	N/A
<b>Seatpost</b>	Orbea Digit 31.6x400mm Race Face Aeffect Dropper 31.6x385/125mm
<b>Saddle</b>	Selle Royal Custom Trail II 2043 HRN Selle Italia XR Trail



## EVEN LOKI HAD A BEGINNING

In Norse mythology, Laufey is the mysterious mother of Loki, one of the most infamous tricksters of all time. Laufey is also the origin of our most clever and versatile bike – Laufey has created a new style of riding. And instead of saying Laufey is tailored for one type of rider, we're going to go ahead and claim this fun-loving machine is perfect for everyone.

**LAUFHEY**





“IT WAS THE FAVORITE BICYCLE IN SOME TESTING CIRCLES, AND IT WAS A SURPRISE TO EVERYONE”.

LEE TRUMPORE, VITAL MTB

## USER

Laufey is an inexpensive trail bike for riders who are new to MTB or are trading XC hardtails that aren't as fun or durable. Laufey also appeals to more experienced riders who want to try a PLUS-compatible bike that can be easily converted to 29. These riders are looking for a versatile bike to fill a number of different roles in their collection.



## LAUFEY TECH



01 HYDROFORMED

02 DOUBLE DUTY / 27+

03 DIGIT

04 TRAIL GEOMETRY

05 BOOST



## HYDROFORMED

We manipulate the shapes and wall-thickness of our aluminum tubing to increase strength and resistance to unwanted flex. Many of the tubes are butted to save weight in the middle of the tubes, away from the stress of the joints and the weld zones. Using aluminum technologies as advanced as our carbon manufacturing ensures our aluminum bikes are never second-best.

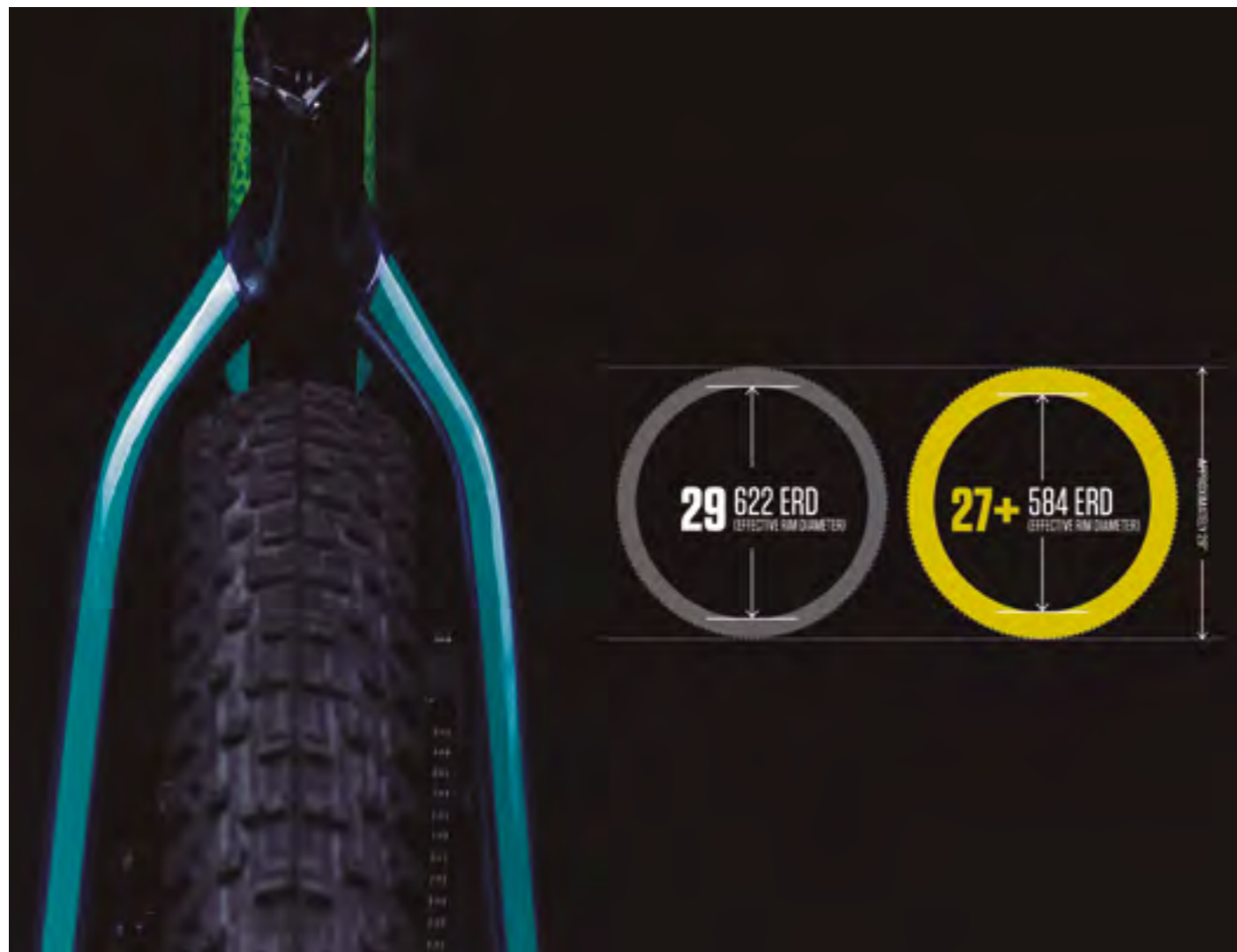

### DOUBLE DUTY 27,5"+ / 29"

Double Duty packs two bikes into one platform. Choose between 27+ and 29 wheel sizes in the same frame. Orbea Trail Geometry remains consistent since the outside diameter of both wheels is similar. 27+ tires are wider than traditional tires and are much higher volume, meaning they can be run at lower pressures. This allows Plus tires to go where regular tires can't, easily handling light mud and snow or sand, greatly expanding the terrain you can cover. Massively increased traction takes climbing grip to new levels and is also immediately apparent in fast corners when the fun starts.

### TRAIL GEOMETRY

Laufey is more aggressive now, thanks to its 130-mm fork and tougher tires. Our height and length measurements are both rational and proportional, to ensure that all cyclists can enjoy the impeccable handling of a lean, fun, fast bike, regardless of frame and wheel size.

### DIGIT

It's not a dropper post – it's a quick adjust post. The need to quickly adjust saddle height for trail conditions spawned the dropper post revolution, but is there a simpler and more reliable solution? Dropper posts are the kings of convenience for continuous, on-the-fly use but their price and need for maintenance makes them impractical for many riders. The patented Orbea Digit Post makes it significantly quicker and easier to stop and adjust saddle height during a ride.



### BOOST



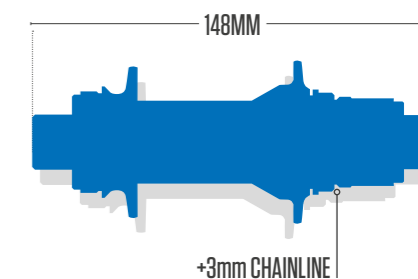

430mm chain stays make Laufey quick, stiff and responsive. Increasing rear axle spacing to 148mm over the 142mm standard moves the chainline outboard by 3mm, increasing the space available at the bottom bracket.



# LAUFEBY

SIZES	S-15"	M-17	L-18.5"	XL-20.5"
1 - Seat Tube (C-T)	381	432	470	520
2 - Top Tube (EFF)	570	599	621	647
3 - Head Tube	100	105	115	130
4 - Chainstay	429,9	429,9	429,9	429,9
5 - BB Height	317.5 (29") / 307.5 (27.5")	317.5 (29") / 307.5 (27.5")	317.5 (29") / 307.5 (27.5")	317.5 (29") / 307.5 (27.5")
6 - BB Drop	60	60	60	60
7 - Wheelbase	1103	1131	1155	1183,5
8 - Head Angle	67°	67°	67°	67°
9 - Seat Angle	73°	73°	73°	73°
10 - Standover	790.6 (29") / 780.6 (27.5")	795.3 (29") / 785.3 (27.5")	803.7 (29") / 793.7 (27.5")	812.7 (29") / 802.7 (27.5")
11 - Reach	383,6	410,2	430	452,6
12 - Stack	620,9	625,5	634,7	648,5
13 - Fork Length	531	531	531	531

HEIGHT (cm)	HEIGHT (in)	SIZE
150-165	59.1"-65.0"	S
160-175	63.0"-68.9"	M
170-185	66.9"-72.8"	L
180-198	70.9"-78.0"	XL

-  Steel Blue-Pistachio (Gloss) **M1**
-  Grey-Purple (Matt) **M2**
-  Orange-Pistachio (Matt-Gloss) **M3**
-  Black-Turquoise (Gloss-Matt) **M4**

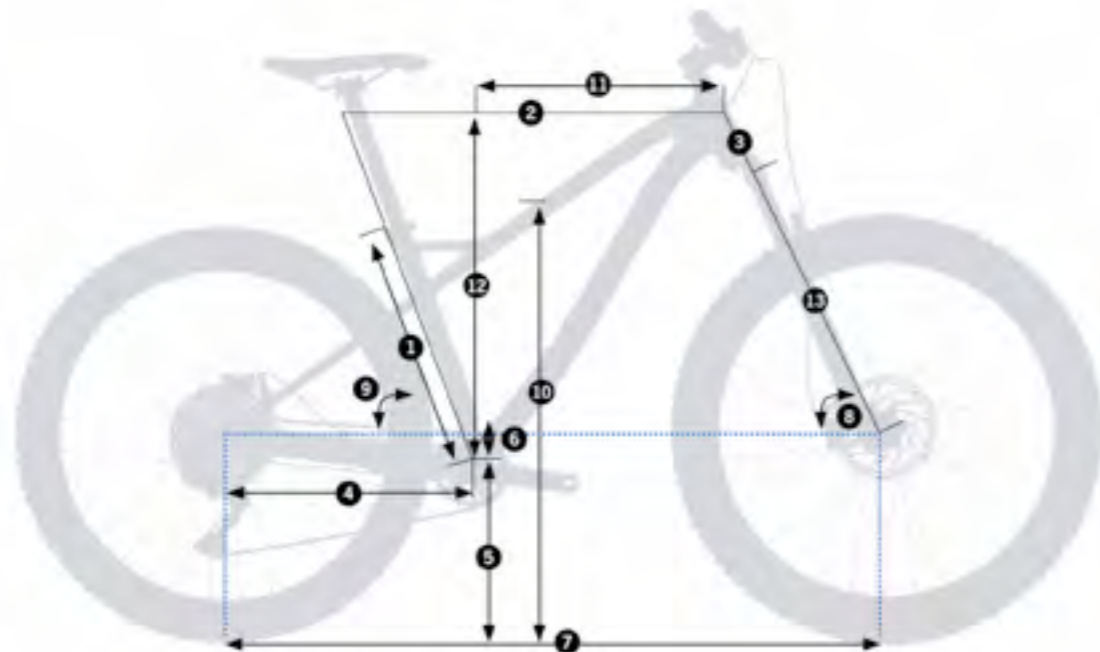

## LAUFEBY 27+ H-LTD *MyO.20*

Code	J272		
Size	Crank	Stem	Handlebar
S	170	50	760
M	170	50	760
L	170	50	760
XL	170	70	760



<b>Frame</b>	Orbea Laufey Hydro 2018 Triple Butted 29/27.5+ design. Boost 12x148 ISCG 05
<b>Fork</b>	Fox 34 Float Factory 130 FIT4 3-Pos-Adj QR15x110 Kashima
<b>Crankset</b>	SRAM Descendant CNC Eagle Dub Boost 32t Rotor QX1 DM Sram 32t Chainring (EXTRA)
<b>Headset</b>	ACROS 1-1/8 - 1-1/2" Integrated
<b>Handlebar</b>	Race Face Aeffect 35 20mm Riser 760mm Race Face Next 35 Riser 20/780mm+Turbine 35 Kit (B)
<b>Stem</b>	Race Face Aeffect 35mm interface
<b>Shifters</b>	SRAM GX Eagle
<b>Brakes</b>	Shimano MT501 BR500 Hydraulic Disc Shimano XT M8000 Hydraulic Disc



<b>Rear Derailleur</b>	SRAM GX Eagle
<b>Chain</b>	SRAM GX Eagle 12-Speed
<b>Wheels</b>	DT M-1900 Spline 35c TLR 15/110mm CL
<b>Cassette</b>	SRAM GX XG-1275 Eagle 10-50t 12-Speed
<b>Tyres</b>	Maxxis High Roller II 3.00" 60 TPI Exo TLR
<b>Pedals</b>	N/A
<b>Seatpost</b>	Race Face Aeffect Dropper 31.6x385/125mm Crank brothers Highline 31,6x425/150mm
<b>Saddle</b>	Selle Italia XR Trail Selle Italia X-LR Ti Flow
<b>Chainguide</b>	OneUp Components ISCG05 Guide

## LAUFEBY 27+ H10 *MyO.20*

Code	J271		
Size	Crank	Stem	Handlebar
S	170	60	760
M	170	60	760
L	170	60	760
XL	170	70	760



<b>Frame</b>	Orbea Laufey Hydro 2018 Triple Butted 29/27.5+ design. Boost 12x148 ISCG 05
<b>Fork</b>	Fox 34 Float Performance 130 3-Position QR15x110 Fox 34 Float Factory 130 FIT4 3-Pos-Adj QR15x110 Kashima
<b>Crankset</b>	SRAM Descendant CNC Eagle Dub Boost 32t Rotor QX1 DM Sram 32t Chainring (EXTRA)
<b>Headset</b>	ACROS 1-1/8 - 1-1/2" Integrated
<b>Handlebar</b>	Orbea OC-II Riser 760mm Race Face Aeffect35 Riser 20/760mm+Aeffect R35 Kit
<b>Stem</b>	Race Face Ride
<b>Shifters</b>	SRAM NX Eagle

<b>Brakes</b>	Shimano MT501 BR500 Hydraulic Disc Shimano XT M8000 Hydraulic Disc
<b>Rear Derailleur</b>	SRAM NX Eagle
<b>Chain</b>	SRAM NX Eagle 12-Speed
<b>Cassette</b>	SRAM NX PG-1230 Eagle 11-50t 12-Speed
<b>Tyres</b>	Maxxis High Roller II 3.00" 60 TPI Exo TLR
<b>Pedals</b>	N/A
<b>Seatpost</b>	Race Face Aeffect Dropper 31.6x385/125mm Crank brothers Highline 31,6x425/150mm
<b>Saddle</b>	Selle Royal Custom Trail II 2043 HRN Selle Italia XR Trail



# LAUFHEY 27+ H30

Code	J270		
<b>Size</b>	<b>Crank</b>	<b>Stem</b>	<b>Handlebar</b>
S	170	60	760
M	170	60	760
L	170	60	760
XL	170	70	760



<b>Frame</b>	Orbea Laufey Hydro 2018 Triple Butted 29/27.5+ design. Boost 12x148 ISCG 05
<b>Fork</b>	RockShox Recon RL 130 Air Q15x110 Boost Fox 34 Float Performance 130 3-Position QR15x110
<b>Crankset</b>	OC-Custom PWI Charm-TT-Boost 32t
<b>Headset</b>	FSA 1-1/8 - 1-1/2" Integrated
<b>Handlebar</b>	Orbea OC-II Riser 760mm Race Face Aeffect35 Riser 20/760mm+Aeffect R35 Kit
<b>Stem</b>	Orbea OC-II
<b>Shifters</b>	Shimano SLX M7000
<b>Brakes</b>	Shimano MT201 Hydraulic Disc Shimano MT501 BR500 Hydraulic Disc

<b>Rear Derailleur</b>	Shimano SLX M7000 GS Shadow Plus Direct Mount
<b>Chain</b>	Shimano HG601-11
<b>Cassette</b>	Sun Race 11-46t 11-Speed
<b>Tyres</b>	Maxxis High Roller II 3.00" 60 TPI Exo TLR
<b>Pedals</b>	N/A
<b>Seatpost</b>	Orbea Digit 31.6x400mm Race Face Aeffect Dropper 31.6x385/125mm
<b>Saddle</b>	Selle Royal Custom Trail II 2043 HRN Selle Italia XR Trail



## AIM FOR THE TOP

Oiz is familiar with the hard work it takes to reach summits, leaderboards and podium steps. We don't need to fabricate a pedigree for this phenomenon - two world championships prove Oiz is a thoroughbred. Oiz and serious cross-country are synonymous, its presence on the World Cup is undeniable. Is the lightest, stiffest and most efficient machine available whether you pin on a number or take it up to the highest peak on your afternoon ride. Oiz has what you need to get there - there is no better weapon to aim for the top.

**OIZ**

“ORBEA’S NEW OIZ HANDLES VERY WELL AND IS EXTREMELY CAPABLE IN BOTH THE 100MM AND 120MM SET-UPS”.

DANIEL SAPP, PINKBIKE



## USER

Oiz has been designed for quick, experienced riders who demand a super lightweight and efficient bike that offers a reliable suspension for technical XC races and top performance in cross country competitions. Oiz is the bike of the CLIF Pro Team and the Orbea Factory Team.

A second new group of users will be XC marathon enthusiasts, once the Oiz becomes available with a 120-mm travel suspension. This bike would be perfect for those riders who like the lightness and efficiency of a pure XC bike, but can't see themselves racing on an Occam, which has a longer suspension travel.

## OIZ TECH



- 01 MONOCOQUE
- 02 FIBERLINK
- 03 DOS BIDONES
- 04 TWO STROKE
- 05 INSIDE LINE
- 06 ADVANCED DYNAMICS



### MONOCOQUE EPS

Oiz uses the most technologically advanced carbon construction available to make the most sophisticated frame possible – A complex and painstaking process with results you will appreciate on the trail. Prepreg carbon sheets are laser cut to minimize excess materials and overlap, and hours of premolding ensure optimal compaction with the smallest amount of carbon. Engineering a frame that uses as much carbon as possible of course saves weight but it also contributes to the sophistication and refinement of Oiz. Features like UFO 2 and Fiberlink take full advantage of carbon's capabilities and put Oiz in a category by itself.

### FIBERLINK

In the quest for stiffness and clean lines, we developed the long-fiber injected Fiberlink. The perfect blend of low weight and impressive rigidity, Fiberlink integrates seamlessly with the shapes of Oiz and the seat tube.

59 G



### TWO BOTTLES

One of the simplest features of of the new Oiz was one of the most complex to accomplish - the MD, LG and XL frames are all equipped with two bottle mounts inside the front triangle. The additional room made available by the Inside Line cable routing puts extra water at your fingertips instead of in your pocket or on your back.





### TWO STROKE

One of the simplest features of the new Oiz was one of the most complex to accomplish - the MD, LG and XL frames are all equipped with two bottle mounts inside the front triangle. The additional room made available by the Inside Line cable routing puts extra water at your fingertips instead of in your pocket or on your back.

### INSIDE LINE

It's the quickest way around the competition - and the optimal route for control cables racing to your fingertips. The proprietary rear shock lockout is completely invisible, hiding from mud and staying out of your way as you grab a water bottle. Controls are accessible and easy to use, creating the smoothest and sexiest shock mounting on the market. It's a small detail, but when your bike is optimized, customized and weaponized, obsession over details can't be trivialized.



### ADVANCED DYNAMICS

Advanced Dynamics is not a design, but a development process. Our unique method transforms virtual models into real, highly-refined machines - Bikes for demanding riders that are faster, more fun to ride and far beyond ordinary.

The suspension kinematics of the Oiz are perfect for efficient XC riding. Sag can be set low for a firm pedaling feel and the design still delivers a full 100/120mm of travel when needed. The leverage ratio increases for the first 3/4 of the shock stroke, then switches to a falling rate to overcome the progressive nature of the air shock to achieve full travel on large impacts. Custom tuning of the damper minimizes bottom-out forces and keeps the suspension riding high, maintaining geometry and efficiency.

*Oiz*

# DESIGN YOUR BIKE

- 01 CHOOSE A MODEL AND SELECT OR SUBSTITUTE YOUR FAVORITE COMPONENTS.
- 02 CREATE A CUSTOM PAINT SCHEME.
- 03 ADD YOUR NAME TO THE TOP TUBE.

WWW.DRBEA.COM

# OIZ OMR

SIZES	S - 27.5"	S - 29"	M - 29"	L - 29"	XL - 29"
1 - Seat Tube (C-T)	405	405	432	470	520
2 - Top Tube (EFF)	557	564	593	617	641
3 - Head Tube	95	90	95	105	120
4 - Chainstay	425	435	435	435	435
5 - BB Height	328	327	327	327	327
6 - BB Drop	29	47	47	47	47
7 - Wheelbase	1081	1094	1123	1148	1173
8 - Head Angle	69°	69°	69°	69°	69°
9 - Seat Angle	75°	75°	75°	75°	75°
10 - Standover		717	732	742	749
11 - Reach	407	407	435	456	476
12 - Stack	558	586	591	600	614
13 - Fork Length	488	504	504	504	504

HEIGHT (cm)	HEIGHT (in)	SIZE
155-170	61.1"-66.9"	S - 27.5"
155-170	61.1"-66.9"	S-29"
165-180	65.0"-70.9"	M - 29"
178-190	70.1"-74.8"	L - 29"
185-198	72.8"-78.0"	XL - 29"

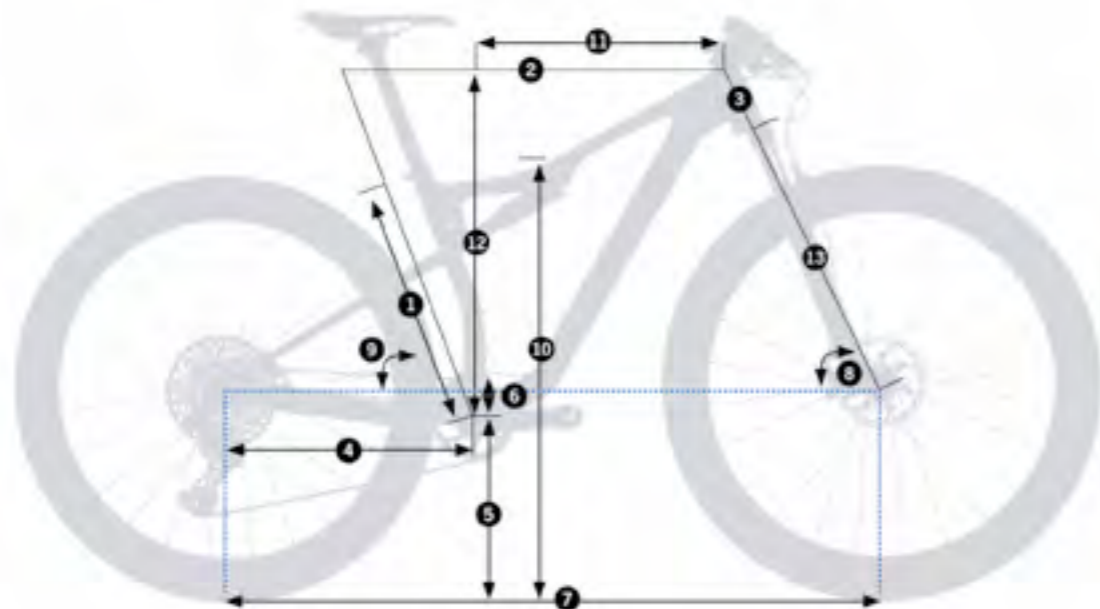
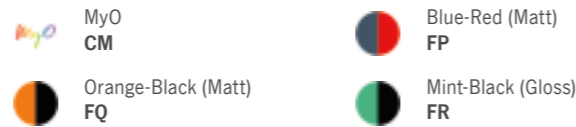

# OIZ M-LTD

Code	J255,J249		
Size	Crank	Stem	Handlebar
S-27	170	70	760
S-29	170	70	760
M-29	175	70	760
L-29	175	90	760
XL-29	175	110	760



<b>Frame</b>	Orbea Oiz Carbon OMR 2019 Boost PF Taper UFO2 I-Line
<b>Shock</b>	Fox i-line DPS Factory Remote Push-Unlock Evol custom tune190x40mm
<b>Fork</b>	Fox 32 Float SC Factory 100 FIT4 Remote-Adj Push-Unlock QR15x110 Kashima 120mm+190x45mm Suspension Pack
<b>Crankset</b>	SRAM XX1 Eagle Dub Gold Boost 34t Rotor QX1 DM Sram 32t Chainring (EXTRA)
<b>Headset</b>	ACROS 1-1/8 - 1-1/2" Integrated
<b>Handlebar</b>	FSA K-Force Flat 760mm Di2 compatible
<b>Stem</b>	FSA K-Force OS-100 CSI
<b>Shifters</b>	SRAM XX1 Eagle Gold



<b>Brakes</b>	SRAM Ultimate Carbon Gold Hydraulic Disc
<b>Rear Derailleur</b>	Shimano XTR M9100 Hydraulic Disc
<b>Chain</b>	SRAM XX1 Eagle 12-Speed Gold
<b>Wheels</b>	Mavic Crossmax Pro Carbon TL 6-Bolt
<b>Cassette</b>	SRAM XX1 XG-1299 Eagle 10-50t 12-Speed
<b>Hub</b>	Fox Kabolt Boost
<b>Tyres</b>	Maxxis Ikon 2.20" TLR 120 TPI 3C Exo
<b>Pedals</b>	N/A
<b>Seatpost</b>	FSA K-Force Light S80 31,6x400mm Di2 compatible

<b>Saddle</b>	Race Face Aeffect Dropper 31.6x385/125mm
<b>Saddle</b>	Selle Italia X-LR Kit Carbonio S

# OIZ M-TEAM

Code	J254,J248		
Size	Crank	Stem	Handlebar
S-27	170	70	760
S-29	170	70	760
M-29	175	70	760
L-29	175	90	760
XL-29	175	110	760



<b>Frame</b>	Orbea Oiz Carbon OMR 2019 Boost PF Taper UFO2 I-Line
<b>Shock</b>	Fox i-line DPS Factory Remote Push-Unlock Evol custom tune190x40mm
<b>Fork</b>	Fox 32 Float SC Factory 100 FIT4 Remote-Adj Push-Unlock QR15x110 Kashima 120mm+190x45mm Suspension Pack
<b>Crankset</b>	Shimano XTR M9100 34t
<b>Headset</b>	ACROS 1-1/8 - 1-1/2" Integrated
<b>Handlebar</b>	FSA K-Force Flat 760mm Di2 compatible
<b>Stem</b>	FSA K-Force OS-100 CSI
<b>Shifters</b>	Shimano XTR M9100
<b>Brakes</b>	Shimano XTR M9100 Hydraulic Disc
<b>Rear Derailleur</b>	Shimano XTR M9100 SGS Shadow Plus
<b>Chain</b>	Shimano CN-M9100-12



<b>Wheels</b>	DT XRC-1200 Spline TLR F-15/110mm R-12/148mm CL (Center Lock) ASL12 (Shimano Microspline 12s)
<b>Cassette</b>	Shimano XTR M9100 10-51t 12-Speed
<b>Tyres</b>	Maxxis Ikon 2.20" TLR 120 TPI 3C Exo
<b>Pedals</b>	N/A
<b>Seatpost</b>	FSA K-Force Light S80 31,6x400mm Di2 compatible
<b>Saddle</b>	Race Face Aeffect Dropper 31.6x385/125mm
<b>Saddle</b>	Selle Italia X-LR Ti Flow
<b>Saddle</b>	Selle Italia X-LR Kit Carbonio S

## OIZ M10 TR



Code	J253,J247			
	<b>Size</b>	<b>Crank</b>	<b>Stem</b>	<b>Handlebar</b>
	S-27	170	70	740
	S-29	170	70	740
	M-29	175	70	740
	L-29	175	70	740
	XL-29	175	90	740



<b>Frame</b>	Orbea Oiz Carbon OMR 2019 Boost PF Taper UFO2 I-Line
<b>Shock</b>	Fox i-line DPS Factory Remote Push-Unlock Evol custom tune190x45mm
<b>Fork</b>	Fox 34 Float SC Factory 120 FIT4 Remote-Adj Push-Unlock QR15x110 Kashima
<b>Crankset</b>	SRAM X1 Eagle Dub Carbon Boost 34t Rotor QX1 DM Sram 32t Chainring (EXTRA) Rotor QX1 DM Sram 34t Chainring (EXTRA)
<b>Headset</b>	ACROS 1-1/8 - 1-1/2" Integrated
<b>Handlebar</b>	FSA SL-K Flat 740mm FSA K-Force Flat 760mm Kit (Bar+Stem)
<b>Stem</b>	FSA SL-K
<b>Shifters</b>	SRAM GX Eagle

<b>Brakes</b>	Shimano XT M8000 Hydraulic Disc Shimano XTR M9100 Hydraulic Disc SRAM Ultimate Carbon Gold Hydraulic Disc
<b>Rear Derailleur</b>	SRAM X01 Eagle Gold
<b>Chain</b>	SRAM GX Eagle 12-Speed
<b>Wheels</b>	Mavic Crossmax Elite TL 6-Bolt Mavic Crossmax Pro Carbon TL 6-Bolt
<b>Cassette</b>	SRAM GX XG-1275 Eagle 10-50t 12-Speed
<b>Tyres</b>	Maxxis Forekaster 2.35" 120 TPI TLR Dual Exo
<b>Pedals</b>	N/A
<b>Seatpost</b>	Race Face Aeffect Dropper 31.6x385/125mm
<b>Saddle</b>	Selle Italia X-LR Ti Flow

Selle Italia X-LR Kit Carbonio S
----------------------------------

## OIZ M10



Code	J252,J246			
	<b>Size</b>	<b>Crank</b>	<b>Stem</b>	<b>Handlebar</b>
	S-27	170	70	740
	S-29	170	70	740
	M-29	175	70	740
	L-29	175	90	740
	XL-29	175	110	740



<b>Frame</b>	Orbea Oiz Carbon OMR 2019 Boost PF Taper UFO2 I-Line
<b>Shock</b>	Fox i-line DPS Factory Remote Push-Unlock Evol custom tune190x40mm
<b>Fork</b>	Fox 32 Float SC Factory 100 FIT4 Remote-Adj Push-Unlock QR15x110 Kashima 120mm+190x45mm Suspension Pack
<b>Crankset</b>	SRAM X1 Eagle Dub Carbon Boost 34t Rotor QX1 DM Sram 32t Chainring (EXTRA) Rotor QX1 DM Sram 34t Chainring (EXTRA)
<b>Headset</b>	ACROS 1-1/8 - 1-1/2" Integrated
<b>Handlebar</b>	FSA SL-K Flat 740mm FSA K-Force Flat 760mm Kit (Bar+S-stem+Spost)

<b>Stem</b>	FSA SL-K
<b>Shifters</b>	SRAM GX Eagle
<b>Brakes</b>	Shimano XT M8000 Hydraulic Disc Shimano XTR M9100 Hydraulic Disc SRAM Ultimate Carbon Gold Hydraulic Disc
<b>Rear Derailleur</b>	SRAM X01 Eagle Gold
<b>Chain</b>	SRAM GX Eagle 12-Speed
<b>Wheels</b>	Mavic Crossmax Elite TL 6-Bolt Mavic Crossmax Pro Carbon TL 6-Bolt
<b>Cassette</b>	SRAM GX XG-1275 Eagle 10-50t 12-Speed
<b>Tyres</b>	Maxxis Ikon 2.20" TLR 120 TPI 3C Exo Maxxis Forekaster 2.35"TLR(F)/Ardent 2,20"TLR(R)
<b>Pedals</b>	N/A

<b>Seatpost</b>	FSA SL-K SB0 31,6x400mm Di2 compatible Race Face Aeffect Dropper 31.6x385/125mm
<b>Saddle</b>	Selle Italia X-LR Ti Flow Selle Italia X-LR Kit Carbonio S

## OIZ OMP

SIZES	S - 27.5"	M - 27.5"	M - 29	L - 29	XL - 29
1 - Seat Tube (C-T)	406	432	432	470	520
2 - Top Tube (EFF)	552	580	589	613	638
3 - Head Tube	100	110	100	110	120
4 - Chainstay	425	425	440	440	440
5 - BB Height	325	325	325	325	325
6 - BB Drop	27	27	45	45	45
7 - Wheelbase	1057	1085	1098	1122	1148
8 - Head Angle	70°	70°	70°	70°	70°
9 - Seat Angle	74°	74°	74°	74°	74°
10 - Standover	701	711	728	748	790
11 - Reach	390	415	417	439	461
12 - Stack	565	574	597	606	616
13 - Fork Length	487.7	487.7	500.8	500.8	500.8

HEIGHT (cm)	HEIGHT (in)	SIZE
155-170	61.1"-66.9"	S - 27.5"
165-180	65.0"-70.9"	M - 27.5"
165-180	65.0"-70.9"	M - 29"
178-190	70.1"-74.8"	L - 29"
185-198	72.8"-78.0"	XL - 29"



Black-Orange (Matt-Gloss) D9



Red-Black (Gloss) DM

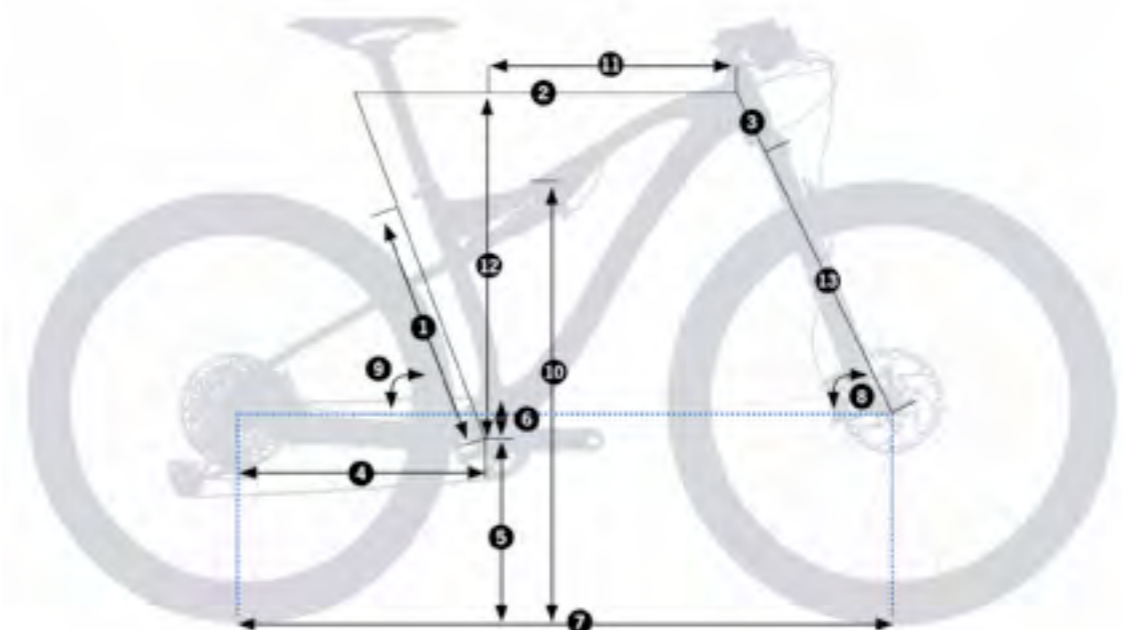

## OIZ M30

MyO<sub>2</sub>

Code	J251,J245		
Size	Crank	Stem	Handlebar
S-27	170	70	720
M-27	175	70	720
M-29	175	70	710
L-29	175	90	710
XL-29	175	110	710



<b>Frame</b>	Orbea Oiz Carbon 29" OMP 2017 Boost Press Fit Taper DCR
<b>Shock</b>	Fox Float DPS Performance Remote Push-lock Evol custom tune 165x38mm
<b>Fork</b>	Fox 32 Float SC Performance 100 Remote Push-Lock QR15x110
<b>Crankset</b>	SRAM X1 Eagle Dub Carbon Boost 34t Rotor QX1 DM Sram 32t Chainring (EXTRA) Rotor QX1 DM Sram 34t Chainring (EXTRA)
<b>Headset</b>	ACROS 1-1/8 - 1-1/2" Integrated
<b>Handlebar</b>	Race Face Ride Flat 710mm FSA SL-K Flat 700mm Kit (Bar+Stem+S-post)
<b>Stem</b>	Race Face Ride

<b>Shifters</b>	SRAM GX Eagle
<b>Brakes</b>	Shimano XT M8000 Hydraulic Disc
<b>Rear Derailleur</b>	SRAM X01 Eagle Gold
<b>Chain</b>	SRAM GX Eagle 12-Speed
<b>Wheels</b>	Mavic Crossmax TL 6-Bolt Mavic Crossmax Elite TL 6-Bolt
<b>Cassette</b>	SRAM GX XG-1275 Eagle 10-50t 12-Speed
<b>Tyres</b>	Maxxis Ikon 2.20" TLR 120 TPI 3C Exo
<b>Pedals</b>	N/A
<b>Seatpost</b>	Race Face Ride 31.6x375mm Race Face Aeffect Dropper 31.6x385/125mm
<b>Saddle</b>	Selle Italia SL X-Cross Flow Selle Italia Lady Flow

Selle Italia X-LR Ti Flow

## OIZ M50

MyO<sub>2</sub>

Code	J250,J244		
Size	Crank	Stem	Handlebar
S-27	170	70	720
M-27	175	70	720
M-29	175	70	720
L-29	175	90	720
XL-29	175	110	720



<b>Frame</b>	Orbea Oiz Carbon 29" OMP 2017 Boost Press Fit Taper DCR
<b>Shock</b>	Fox Float DPS Performance Remote Push-lock Evol custom tune 165x38mm
<b>Fork</b>	Fox 32 Float SC Performance 100 Remote Push-Lock QR15x110
<b>Crankset</b>	SRAM Stylo CNC Eagle Dub Boost 34t Rotor QX1 DM Sram 32t Chainring (EXTRA) Rotor QX1 DM Sram 34t Chainring (EXTRA)
<b>Headset</b>	ACROS 1-1/8 - 1-1/2" Integrated
<b>Handlebar</b>	Orbea OC-II Flat 720mm FSA SL-K Flat 700mm Kit (Bar+Stem+S-post)
<b>Stem</b>	Race Face Ride

<b>Shifters</b>	SRAM NX Eagle
<b>Brakes</b>	Shimano MT501 BR500 Hydraulic Disc Shimano XT M8000 Hydraulic Disc
<b>Rear Derailleur</b>	SRAM NX Eagle
<b>Chain</b>	SRAM NX Eagle 12-Speed
<b>Wheels</b>	Mavic Crossmax TL 6-Bolt
<b>Cassette</b>	SRAM NX PG-1230 Eagle 11-50t 12-Speed
<b>Tyres</b>	Maxxis Ikon 2.20" TLR 120 TPI 3C Exo
<b>Pedals</b>	N/A
<b>Seatpost</b>	Race Face Ride 31.6x375mm Race Face Aeffect Dropper 31.6x385/125mm
<b>Saddle</b>	Selle Italia SL X-Cross Flow Selle Italia Lady Flow

Selle Italia X-LR Ti Flow



## FOR THE FASTEST

Alma is for the the quickest lap times. The steepest climbs. Alma is for the strongest accelerations and highest altitudes. Alma is for the biggest stages, the loudest fans and the toughest riders. Alma is for the fiercest competitors, the athletes who accept nothing less than superlatives. When a few fleeting seconds separate fast from faster, Alma is for the fastest.

**ALMA**

“I LOVE THE ALMA. IT’S LIGHT,  
PLAYFUL AND RESPONSIVE TO  
ACCELERATION JUST WHAT I AM  
LOOKING FOR IN A RACE BIKE”.

CATHERINE PENDREL, CLIF PRO TEAM



## USER

Alma is the choice of elite racers and riders who demand the most efficient bike with the best performance – athletes who are looking for leading technology and style and appreciate a bike that stands out. Alma riders know that a great bike will make them faster. Alma is the racing bicycle of Clif Pro Team.

## ALMA TECH



- 01 MONOCOQUE
- 02 4X4 DYNAMIC STRUCTURE
- 03 BWC
- 04 BOOST
- 05 WORLD CUP GEOMETRY
- 06 SPIRIT FORK



## MONOCOQUE

Alma uses the most technologically advanced carbon construction available to make the most sophisticated frame possible – A complex and painstaking process with results you will appreciate on the trail. The premier Alma OMR frame blends Toray T700, T800 and M40J fibers.

Prepreg carbon sheets are laser cut to minimize excess materials and overlap, and hours of pre-molding ensure optimal compaction with the smallest amount of carbon. A full EPS (Expanded Polystyrene) mold is used to eliminate wrinkles and imperfections.

### 4X4 DYNAMIC STRUCTURE

External forces on the frame under the rider's weight – cornering stresses or vibration from impacts – have a large effect on control and traction. Creating a natural flex point in the top tube by adding a fourth bend offers an efficient, smooth ride that feels like floating over rough terrain. In addition, the seat stays of the new Alma are thinner to give maximum traction and control over rough surfaces without compromising global rigidity. The top tube is robust at the head tube where it contributes to torsional stiffness, but quickly tapers to eliminate unnecessary material.



### BWC

Orbea's Big Wheels Concept (BWC) is simple... Instead of trying to squeeze everybody on a single wheel size, we offer Big Wheels that are scaled to fit riders of any height. BWC offers five frames in two wheel sizes – Small and Medium frames with 27.5" wheels, Small, Medium, Large and XL frames with 29" wheels. Every rider experiences our legendary XC ride quality in a svelte, fun and fast bike regardless of frame size or wheel size.

15.5 / SM	17.5 / MD	<b>27.5</b>		
15.5 / SM	17.5 / MD	19 / LG	21 / XL	<b>29</b>

**+20%**  
MORE RIGID

**+10%**  
MORE COMFORTABLE

### WORLD CUP GEOMETRY

Refinements of Alma's World Cup Geometry reflect the evolution of elite racing. A slacker head angle (69.3°/69.5°) provides stability on increasingly demanding tracks. A steeper seat angle and lower stack height increases handling precision and pedaling efficiency. Shorter (420/430mm) chainstays deliver maximum agility without instability.







**BOOST**

Alma becomes more precise and responsive with 420/430mm chainstays and the increased rigidity of a 12mm through-axle system. The Boost 148 standard widens rear axle spacing to 148mm which moves the chainline outboard by 3mm and increases the space available at the bottom bracket. 3mm doesn't sound like much, but it means that chainstays can be 10mm shorter while increasing tire clearance to allow 2.4" tires. All of it adds up to more durability, nimble handling and a bike that tracks better through rough terrain.

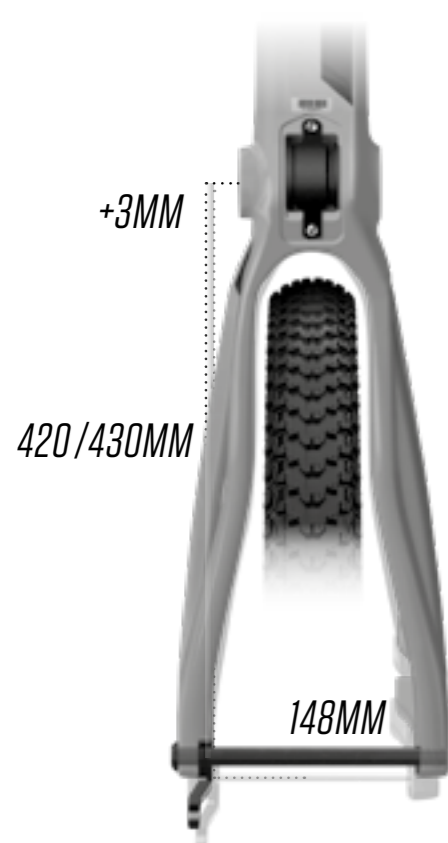

**SPIRIT FORK**

Spirit and Alma go hand in hand - a rigid fork isn't for everyone, but it might be perfect for you. When the conditions call for 575g of speed and razor-sharp handling, a carbon fork tuned specifically for your Alma isn't just "nice," it is essential to making Alma the best XC hardtail system available.

Compatibility with Boost and traditional spacing with room for 2.8" tires make Spirit a standout among competitors. Available in 29" & 27.5", Spirit is compatible with any tapered headtube hardtail and is available through the MyO program in hundreds of custom color combinations to match your trusty rig.

*MyO*

**DESIGN YOUR BIKE**

**01 CHOOSE A MODEL AND SELECT OR SUBSTITUTE YOUR FAVORITE COMPONENTS.**

**02 CREATE A CUSTOM PAINT SCHEME.**





**03 ADD YOUR NAME TO THE TOPE TUBE.**

[WWW.ORBEA.COM](http://www.orbea.com)

# ALMA OMR

SIZES	S – 27.5"	S – 29"	M – 27.5"	M – 29"	L – 29"	XL – 29"
1 - Seat Tube (C-T)	400	400	445	445	483	533
2 - Top Tube (EFF)	550	557	582	588	616	640
3 - Head Tube	95	90	105	95	105	120
4 - Chainstay	420	430	420	430	430	430
5 - BB Height	312	61	312	309	309	309
6 - BB Drop	43	309	43	61	61	61
7 - Wheelbase	1045	1061	1078	1092	1121	1146
8 - Head Angle	69.3°	69.3°	69.3°	69.5°	69.5°	69.5°
9 - Seat Angle	73.5°	73.5°	73.5°	73.5°	73.5°	73.5°
10 - Standover	716	715	735	735	741	802
11 - Reach	380	380	409	409	435	455
12 - Stack	573		583	602	611	625
13 - Fork Length	487,7	500,8	487,7	500,8	500,8	500,8

HEIGHT (cm)	HEIGHT (in)	SIZE
155-170	61.1"-66.9"	S – 27.5"
155-170	61.1"-66.9"	S-29"
165-180	65.0"-70.9"	M – 27.5"
165-180	65.0"-70.9"	M – 29"
178-190	70.1"-74.8"	L – 29"
185-198	72.8"-78.0"	XL – 29"

-  MyO  
**CM**
-  Black-Anthracite-Orange (Matt) **DT**
-  Anthracite-Black (Gloss)  
**FL / DR**
-  Bright red-Red-Blue (Matt)  
**FN / DU**
-  Mint-Black (Gloss)  
**DS / FM**

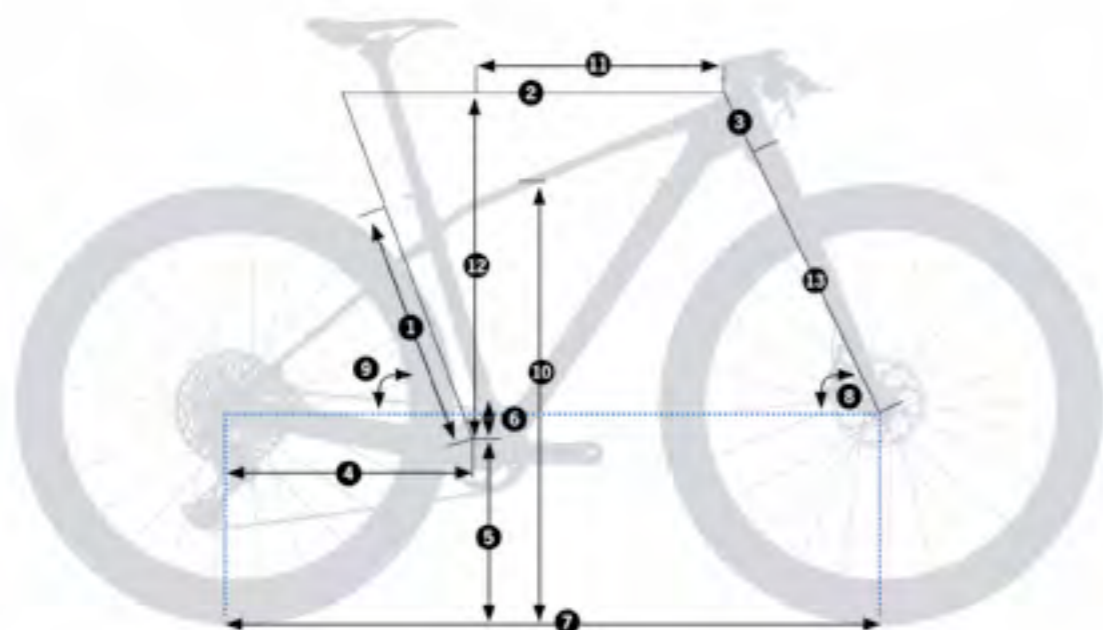

# ALMA M-LTD



Code	J243,J236		
Size	Crank	Stem	Handlebar
S-27	170	70	700
S-29	170	70	700
M-27	175	70	700
M-29	175	70	700
L-29	175	90	700
XL-29	175	110	700



<b>Frame</b>	Orbea Alma Carbon OMR 2017 Boost Taper PF DCR
<b>Fork</b>	Orbea Spirit Rigid Carbon 15x110 Fox 32 Float SC Factory 100 FIT4 Remote PTU QR15x110 Kashima
<b>Crankset</b>	SRAM XX1 Eagle Dub Gold Boost 34t Rotor QX1 DM Sram 32t Chainring (EXTRA) Rotor QX1 DM Sram 34t Chainring (EXTRA)
<b>Headset</b>	ACROS 1-1/8 - 1-1/2" Integrated
<b>Handlebar</b>	FSA K-Force Flat 700mm Di2 compatible
<b>Stem</b>	FSA K-Force OS-100 CSI
<b>Shifters</b>	SRAM XX1 Eagle Gold
<b>Brakes</b>	SRAM Ultimate Carbon Gold Hydraulic Disc



<b>Rear Derailleur</b>	Shimano XTR M9100 Hydraulic Disc SRAM XX1 Eagle Gold
<b>Chain</b>	SRAM XX1 Eagle 12-Speed Gold
<b>Wheels</b>	Mavic Crossmax Pro Carbon TL 6-Bolt
<b>Cassette</b>	SRAM XX1 XG-1299 Eagle 10-50t 12-Speed
<b>Tyres</b>	Maxxis Ikon 2.20" TLR 120 TPI 3C Exo
<b>Pedals</b>	N/A
<b>Seatpost</b>	FSA K-Force Light SB0 27,2x400mm Di2 compatible
<b>Saddle</b>	Selle Italia X-LR Kit Carbonio S

# ALMA M-TEAM



Code	J242,J235		
Size	Crank	Stem	Handlebar
S-27	170	70	700
S-29	170	70	700
M-27	175	70	700
M-29	175	70	700
L-29	175	90	700
XL-29	175	110	700



<b>Frame</b>	Orbea Alma Carbon OMR 2017 Boost Taper PF DCR
<b>Fork</b>	Orbea Spirit Rigid Carbon 15x110 Fox 32 Float SC Factory 100 FIT4 Remote-Adj Push-Unlock QR15x110 Kashima
<b>Crankset</b>	Shimano XTR M9100 34t
<b>Headset</b>	ACROS 1-1/8 - 1-1/2" Integrated
<b>Handlebar</b>	FSA K-Force Flat 700mm Di2 compatible
<b>Stem</b>	FSA K-Force OS-100 CSI
<b>Shifters</b>	Shimano XTR M9100
<b>Brakes</b>	Shimano XTR M9100 Hydraulic Disc
<b>Rear Derailleur</b>	Shimano XTR M9100 SGS Shadow Plus
<b>Chain</b>	Shimano CN-M9100-12



<b>Wheels</b>	DT XRC-1200 Spline TLR F-15/110mm R-12/148mm CL (Center Lock) ASL12 (Shimano Microspline 12s)
<b>Cassette</b>	Shimano XTR M9100 10-51t 12-Speed
<b>Tyres</b>	Maxxis Ikon 2.20" TLR 120 TPI 3C Exo
<b>Pedals</b>	N/A
<b>Seatpost</b>	FSA K-Force Light SB0 27,2x400mm Di2 compatible
<b>Saddle</b>	Selle Italia X-LR Ti Flow Selle Italia X-LR Kit Carbonio S

## ALMA M10



<b>Code</b>	J241,J234		
<b>Size</b>	<b>Crank</b>	<b>Stem</b>	<b>Handlebar</b>
S-27	170	70	700
S-29	170	70	700
M-27	175	70	700
M-29	175	70	700
L-29	175	90	700
XL-29	175	110	700



<b>Frame</b>	Orbea Alma Carbon OMR 2017 Boost Taper PF DCR
<b>Fork</b>	Fox 32 Float SC Factory 100 FIT4 Remote-Adj Push-Unlock QR15x110 Kashima Orbea Spirit Rigid Carbon 15x110
<b>Crankset</b>	SRAM X1 Eagle Dub Carbon Boost 34t Rotor QX1 DM Sram 32t Chainring (EXTRA) Rotor QX1 DM Sram 34t Chainring (EXTRA)
<b>Headset</b>	ACROS 1-1/8 - 1-1/2" Integrated
<b>Handlebar</b>	FSA SL-K Flat 700mm FSA K-Force Flat 700mm Kit (Bar+S-tem+Spost)
<b>Stem</b>	FSA SL-K
<b>Shifters</b>	SRAM X01 Eagle

<b>Brakes</b>	Shimano XT M8000 Hydraulic Disc SRAM Ultimate Carbon Gold Hydraulic Disc
<b>Rear Derailleur</b>	SRAM X01 Eagle Gold
<b>Chain</b>	SRAM GX Eagle 12-Speed
<b>Wheels</b>	Mavic Crossmax Elite TL 6-Bolt Mavic Crossmax Pro Carbon TL 6-Bolt
<b>Cassette</b>	SRAM GX XG-1275 Eagle 10-50t 12-Speed
<b>Tyres</b>	Maxxis Ikon 2.20" TLR 120 TPI 3C Exo
<b>Pedals</b>	N/A
<b>Seatpost</b>	FSA SL-K SBO 27,2x400mm Di2 compatible
<b>Saddle</b>	Selle Italia X-LR Ti Flow Selle Italia Lady Flow Selle Italia X-LR Kit Carbonio S

## ALMA M15



<b>Code</b>	J240,J233		
<b>Size</b>	<b>Crank</b>	<b>Stem</b>	<b>Handlebar</b>
S-27	170	70	710
S-29	170	70	710
M-27	175	70	710
M-29	175	70	710
L-29	175	90	710
XL-29	175	110	710



<b>Fork</b>	Fox 32 Float SC Factory 100 FIT4 Remote-Adj Push-Unlock QR15x110 Kashima Orbea Spirit Rigid Carbon 15x110
<b>Headset</b>	ACROS 1-1/8 - 1-1/2" Integrated
<b>Brakes</b>	Shimano XT M8000 Hydraulic Disc SRAM Ultimate Carbon Gold Hydraulic Disc
<b>Chain</b>	SRAM GX Eagle 12-Speed
<b>Seatpost</b>	Race Face Ride 27.2x375mm

## ALMA OMP

SIZES	S - 27.5"	S - 29"	M - 27.5"	M - 29"	L - 29"	XL - 29"
1 - Seat Tube (C-T)	400	400	445	445	483	533
2 - Top Tube (EFF)	550	557	582	588	616	640
3 - Head Tube	105	95	115	105	115	130
4 - Chainstay	425	436	425	436	436	436
5 - BB Height	312	309	312	309	309	309
6 - BB Drop	43	61	43	61	61	61
7 - Wheelbase	1045	1073	1078	1092	1121	1146
8 - Head Angle	69°	69°	69°	69°	69°	69°
9 - Seat Angle	44°	73.5°	44°	44°	44°	44°
10 - Standover	716	715	735	735	741	802
11 - Reach	380	380	409	409	435	455
12 - Stack	581	600	590	609	618	632
13 - Fork Length	487,7	500,8	487,7	500,8	500,8	500,8

HEIGHT (cm)	HEIGHT (in)	SIZE
155-170	61.1"-66.9"	S - 27.5"
155-170	61.1"-66.9"	S-29"
165-180	65.0"-70.9"	M - 27.5"
165-180	65.0"-70.9"	M - 29"
178-190	70.1"-74.8"	L - 29"
185-198	72.8"-78.0"	XL - 29"

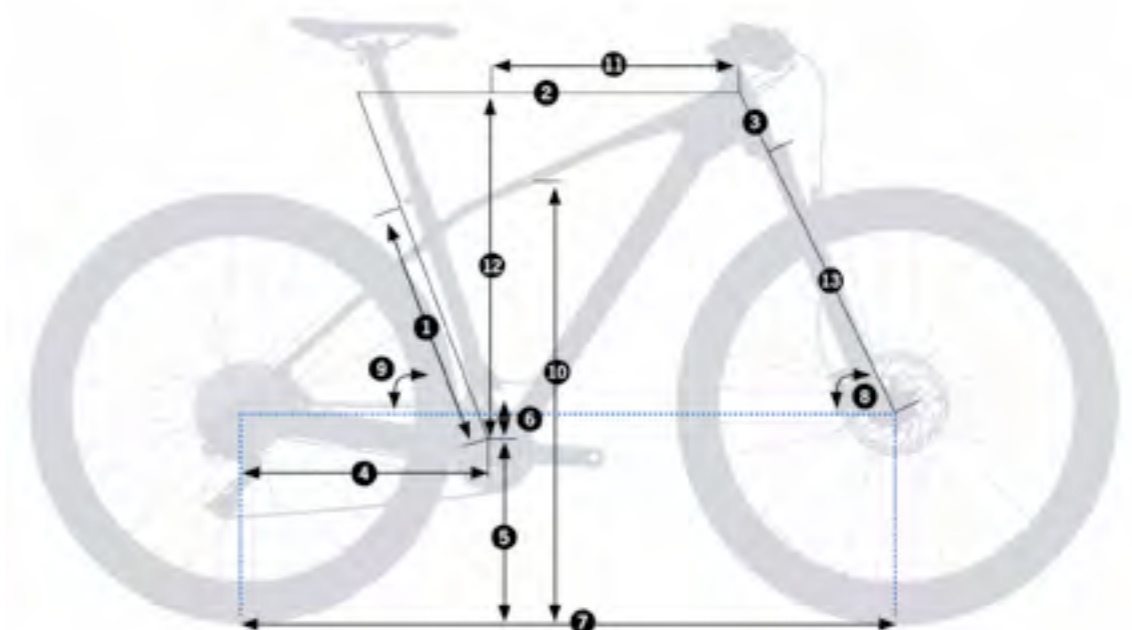
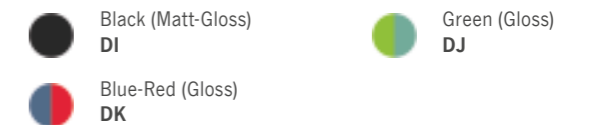

## ALMA M25

MyO<sub>2.0</sub>

Code	J239,J232		
Size	Crank	Stem	Handlebar
S-27	170	70	720
S-29	170	70	720
M-27	175	70	720
M-29	175	70	720
L-29	175	90	720
XL-29	175	110	720



<b>Frame</b>	Orbea Alma Carbon OMP 2018 Boost Press Fit Taper
<b>Fork</b>	Fox 32 Float SC Performance 100 Remote Push-Lock QR15x110 Fox 32 Float SC Factory 100 FIT4 Remote PTU QR15x110 Kashima
<b>Crankset</b>	SRAM Stylo CNC Eagle Dub Boost 34t Rotor QX1 DM Sram 32t Chainring (EXTRA) Rotor QX1 DM Sram 34t Chainring (EXTRA)
<b>Headset</b>	ACROS 1-1/8 - 1-1/2" Integrated
<b>Handlebar</b>	Orbea OC-II Flat 720mm FSA SL-K Flat 700mm Kit (Bar+Stem+S-post)
<b>Stem</b>	Race Face Ride

<b>Shifters</b>	SRAM GX Eagle
<b>Brakes</b>	Shimano MT501 BR500 Hydraulic Disc Shimano XT M8000 Hydraulic Disc
<b>Rear Derailleur</b>	SRAM X01 Eagle Gold
<b>Chain</b>	SRAM GX Eagle 12-Speed
<b>Wheels</b>	Mavic Crossmax TL 6-Bolt Mavic Crossmax Elite TL 6-Bolt
<b>Cassette</b>	SRAM GX XG-1275 Eagle 10-50t 12-Speed
<b>Tyres</b>	Maxxis Ikon 2.20" TLR 120 TPI 3C Exo
<b>Pedals</b>	N/A
<b>Seatpost</b>	Race Face Ride 27.2x375mm
<b>Saddle</b>	Selle Italia SL X-Cross Flow Selle Italia Lady Flow Selle Italia X-LR Ti Flow

## ALMA M30

MyO<sub>2.0</sub>

Code	J238,J231		
Size	Crank	Stem	Handlebar
S-27	170	70	720
S-29	170	70	720
M-27	175	70	720
M-29	175	70	720
L-29	175	90	720
XL-29	175	110	720



<b>Frame</b>	Orbea Alma Carbon OMP 2018 Boost Press Fit Taper
<b>Fork</b>	RockShox Reba RL 100 Air QR15x110 Boost Fox 32 Float SC Performance 100 PTL QR15x110
<b>Crankset</b>	SRAM Stylo CNC Eagle Dub Boost 34t Rotor QX1 DM Sram 32t Chainring (EXTRA) Rotor QX1 DM Sram 34t Chainring (EXTRA)
<b>Headset</b>	ACROS 1-1/8 - 1-1/2" Integrated
<b>Handlebar</b>	Orbea OC-II Flat 720mm FSA SL-K Flat 700mm Kit (Bar+Stem+S-post)
<b>Stem</b>	Race Face Ride

<b>Shifters</b>	SRAM NX Eagle
<b>Brakes</b>	Shimano MT501 BR500 Hydraulic Disc Shimano XT M8000 Hydraulic Disc
<b>Rear Derailleur</b>	SRAM NX Eagle
<b>Chain</b>	SRAM NX Eagle 12-Speed
<b>Wheels</b>	Mach1 Klíxx 23c Tubeless Ready Mavic Crossmax TL 6-Bolt (Maxxis Ikon TLR included)
<b>Cassette</b>	SRAM NX PG-1230 Eagle 11-50t 12-Speed
<b>Tyres</b>	Maxxis Ikon 2.20" FB 60 TPI Dual Maxxis Ikon 2.20" TLR 120 TPI 3C Exo
<b>Pedals</b>	N/A
<b>Seatpost</b>	Race Face Ride 27.2x375mm
<b>Saddle</b>	Selle Royal Seta Sport

Selle Italia SL X-Cross Flow
Selle Italia Lady Flow

## ALMA M50-REBA

MyO<sub>2.0</sub>

Code	J237,J230		
Size	Crank	Stem	Handlebar
S-27	170	70	720
S-29	170	70	720
M-27	175	70	720
M-29	175	70	720
L-29	175	90	720
XL-29	175	110	720



<b>Frame</b>	Orbea Alma Carbon OMP 2018 Boost Press Fit Taper
<b>Fork</b>	RockShox Reba RL 100 Air QR15x110 Boost Fox 32 Float SC Performance 100 PTL QR15x110
<b>Crankset</b>	Prowheel Claw-551-TT-Boost 26x36t Race Face Aeffect Cinch 32t (11-46T Cass)
<b>Headset</b>	ACROS 1-1/8 - 1-1/2" Integrated
<b>Handlebar</b>	Orbea OC-II Flat 720mm Race Face Ride Flat 710mm Kit (Bar+S-tem+Spost)
<b>Stem</b>	Orbea OC-II
<b>Shifters</b>	Shimano SLX M7000
<b>Brakes</b>	Shimano MT201 Hydraulic Disc

<b>Rear Derailleur</b>	Shimano MT501 BR500 Hydraulic Disc Shimano XT M8000 GS Shadow Plus Direct Mount
<b>Front Derailleur</b>	Shimano Deore M7020 31,8mm
<b>Chain</b>	Shimano HG601-11
<b>Wheels</b>	Mach1 Klíxx 23c Tubeless Ready Mavic Crossmax TL 6-Bolt (Maxxis Ikon TLR included)
<b>Cassette</b>	Sun Race 11-42t 11-Speed
<b>Tyres</b>	Maxxis Ikon 2.20" FB 60 TPI Dual Maxxis Ikon 2.20" TLR 120 TPI 3C Exo
<b>Pedals</b>	N/A
<b>Seatpost</b>	Orbea OC-II 27.2x400mm
<b>Saddle</b>	Selle Royal Seta Sport Selle Italia SL X-Cross Flow

Selle Italia Lady Flow
------------------------

## ALMA M50-EAGLE

MyO<sub>2.0</sub>

Code	J277,J276		
Size	Crank	Stem	Handlebar
S-27	170	70	720
S-29	170	70	720
M-27	175	70	720
M-29	175	70	720
L-29	175	90	720
XL-29	175	110	720



<b>Frame</b>	Orbea Alma Carbon OMP 2018 Boost Press Fit Taper
<b>Fork</b>	RockShox Recon TK 100 Air Remote Q15x110 Boost RockShox Reba RL 100 Air QR15x110 Boost
<b>Crankset</b>	SRAM Stylo CNC Eagle Dub Boost 34t Rotor QX1 DM Sram 32t Chainring (EXTRA) Rotor QX1 DM Sram 34t Chainring (EXTRA)
<b>Headset</b>	ACROS 1-1/8 - 1-1/2" Integrated
<b>Handlebar</b>	Orbea OC-II Flat 720mm Race Face Ride Flat 710mm Kit (Bar+S-tem+Spost)
<b>Stem</b>	Orbea OC-II



<b>Shifters</b>	SRAM NX Eagle
<b>Brakes</b>	Shimano MT201 Hydraulic Disc Shimano MT501 BR500 Hydraulic Disc
<b>Rear Derailleur</b>	SRAM NX Eagle
<b>Chain</b>	SRAM NX Eagle 12-Speed
<b>Wheels</b>	Mach1 Klíxx 23c Tubeless Ready Mavic Crossmax TL 6-Bolt (Maxxis Ikon TLR included)
<b>Cassette</b>	SRAM NX PG-1230 Eagle 11-50t 12-Speed (EXTRA)
<b>Tyres</b>	Maxxis Ikon 2.20" FB 60 TPI Dual Maxxis Ikon 2.20" TLR 120 TPI 3C Exo
<b>Pedals</b>	N/A
<b>Seatpost</b>	Orbea OC-II 27.2x400mm
<b>Saddle</b>	Selle Royal Seta Sport

Selle Italia SL X-Cross Flow
Selle Italia Lady Flow

# ALMA H

SIZES	S – 27.5"	S – 29"	M – 27.5"	M – 29"	L – 29"	XL – 29"
1 - Seat Tube (C-T)	400	400	445	445	483	533
2 - Top Tube (EFF)	550	557	582	588	616	640
3 - Head Tube	105	95	115	105	115	130
4 - Chainstay	425	436	425	436	436	436
5 - BB Height	312	309	312	309	309	309
6 - BB Drop	43	61	43	61	61	61
7 - Wheelbase	1045	1073	1078	1092	1121	1146
8 - Head Angle	69°	69°	69°	69°	69°	69°
9 - Seat Angle	73.5°	73.5°	73.5°	73.5°	73.5°	73.5°
10 - Standover	716	715	735	735	741	802
11 - Reach	380	380	409	409	435	455
12 - Stack	581	600	590	609	618	632
13 - Fork Length	487,7	500,8	487,7	500,8	500,8	500,8

HEIGHT (cm)	HEIGHT (in)	SIZE
155-170	61.1"-66.9"	S – 27.5"
155-170	61.1"-66.9"	S-29"
165-180	65.0"-70.9"	M – 27.5"
165-180	65.0"-70.9"	M – 29"
178-190	70.1"-74.8"	L – 29"
185-198	72.8"-78.0"	XL – 29"

-  Black (Gloss-Matt) **DE / DN**
-  Blue-Orange (Matt) **DZ / DQ**
-  Mint-Black (Gloss) **DP / DY**

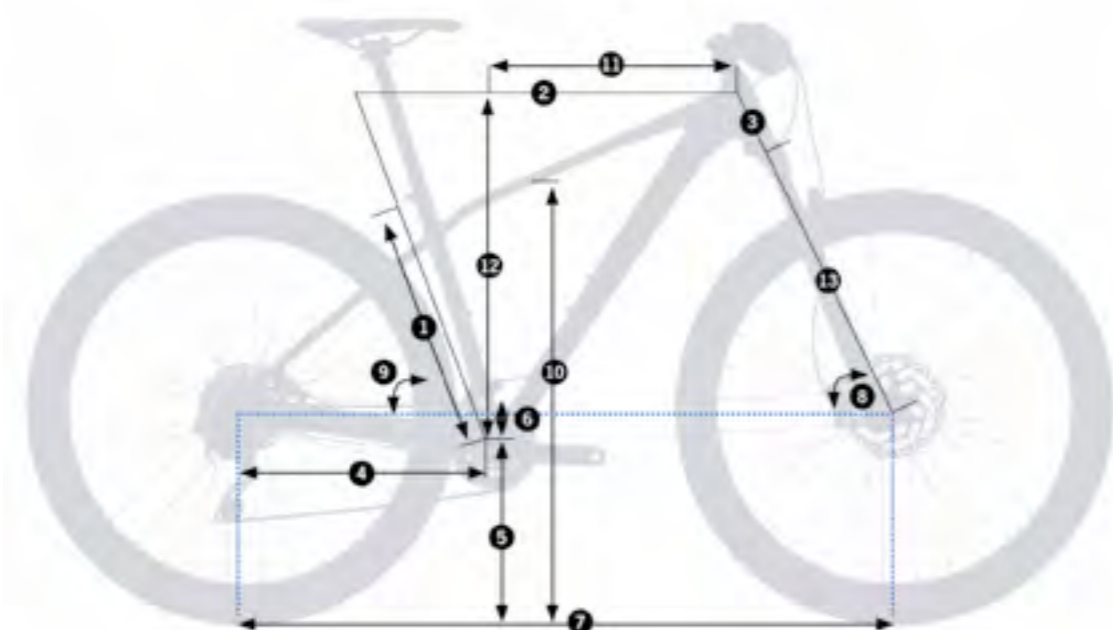

# ALMA H10

MyO<sub>2.0</sub>

Code	J229,J226		
Size	Crank	Stem	Handlebar
S-27	170	70	720
S-29	170	70	720
M-27	175	70	720
M-29	175	70	720
L-29	175	90	720
XL-29	175	110	720



<b>Frame</b>	Orbea Alma Hydro 2019 Boost Triple Butted 4X4 Taper PF Race
<b>Fork</b>	RockShox Reba RL 100 Air QR15x110 Boost Fox 32 Float SC Performance 100 PTL QR15x110
<b>Crankset</b>	SRAM Stylo CNC Eagle Dub Boost 34t Rotor QX1 DM Sram 32t Chainring (EXTRA) Rotor QX1 DM Sram 34t Chainring (EXTRA)
<b>Headset</b>	ACROS 1-1/8 - 1-1/2" Integrated
<b>Handlebar</b>	Orbea OC-II Flat 720mm Race Face Ride Flat 710mm Kit (Bar+S-tem+Spost)
<b>Stem</b>	Orbea OC-II



<b>Shifters</b>	SRAM NX Eagle
<b>Brakes</b>	Shimano MT501 BR500 Hydraulic Disc Shimano XT M8000 Hydraulic Disc
<b>Rear Derailleur</b>	SRAM NX Eagle
<b>Chain</b>	SRAM NX Eagle 12-Speed
<b>Wheels</b>	Mach1 Klixx 23c Tubeless Ready
<b>Cassette</b>	SRAM NX PG-1230 Eagle 11-50t 12-Speed
<b>Tyres</b>	Maxxis Ikon 2.20" FB 60 TPI Dual Maxxis Ikon 2.20" TLR 120 TPI 3C Exo
<b>Pedals</b>	N/A
<b>Seatpost</b>	Orbea OC-II 27.2x400mm Orbea Digit 27.2x400mm
<b>Saddle</b>	Selle Royal Seta Sport Selle Italia SL X-Cross Flow

Selle Italia Lady Flow

# ALMA H30-XT

MyO<sub>2.0</sub>

Code	J228,J225		
Size	Crank	Stem	Handlebar
S-27	170	70	720
S-29	170	70	720
M-27	175	70	720
M-29	175	70	720
L-29	175	90	720
XL-29	175	110	720



<b>Frame</b>	Orbea Alma Hydro 2019 Boost Triple Butted 4X4 Taper PF Race
<b>Fork</b>	RockShox Recon TK 100 Air Remote Q15x110 Boost RockShox Reba RL 100 Air QR15x110 Boost
<b>Crankset</b>	OC-Custom PW Claw-551-TT 26x36t Race Face Aeffect Cinch 32t (11-46T Cass)
<b>Headset</b>	FSA 1-1/8 - 1-1/2" Integrated
<b>Handlebar</b>	Orbea OC-II Flat 720mm Race Face Ride Flat 710mm Kit (Bar+S-tem+Spost)
<b>Stem</b>	Orbea OC-II
<b>Shifters</b>	Shimano SLX M7000
<b>Brakes</b>	Shimano MT201 Hydraulic Disc



<b>Brakes</b>	Shimano MT501 BR500 Hydraulic Disc
<b>Rear Derailleur</b>	Shimano XT M8000 GS Shadow Plus Direct Mount
<b>Front Derailleur</b>	Shimano SLX M7020
<b>Chain</b>	Shimano HG601-11
<b>Wheels</b>	Mach1 Klixx 23c Tubeless Ready
<b>Cassette</b>	Sun Race 11-42t 11-Speed
<b>Tyres</b>	Maxxis Ikon 2.20" FB 60 TPI Dual Maxxis Ikon 2.20" TLR 120 TPI 3C Exo
<b>Pedals</b>	N/A
<b>Seatpost</b>	Orbea OC-II 27.2x400mm Orbea Digit 27.2x400mm
<b>Saddle</b>	Selle Royal Seta Sport Selle Italia SL X-Cross Flow

Selle Italia Lady Flow

## ALMA H30-EAGLE *MyO<sub>2.0</sub>*

Code	J279,J278		
Size	Crank	Stem	Handlebar
S-27	170	70	720
S-29	170	70	720
M-27	175	70	720
M-29	175	70	720
L-29	175	90	720
XL-29	175	110	720



<b>Frame</b>	Orbea Alma Hydro 2019 Boost Triple Butted 4X4 Taper PF Race
<b>Fork</b>	RockShox Recon TK 100 Air Remote Q15x110 Boost RockShox Reba RL 100 Air QR15x110 Boost
<b>Crankset</b>	SRAM Stylo CNC Eagle Dub Boost 34t Rotor QX1 DM Sram 32t Chainring (EXTRA) Rotor QX1 DM Sram 34t Chainring (EXTRA)
<b>Headset</b>	FSA 1-1/8 - 1-1/2" Integrated
<b>Handlebar</b>	Orbea OC-II Flat 720mm Race Face Ride Flat 710mm Kit (Bar+S-tem+Spost)
<b>Stem</b>	Orbea OC-II



<b>Shifters</b>	SRAM NX Eagle
<b>Brakes</b>	Shimano MT201 Hydraulic Disc Shimano MT501 BR500 Hydraulic Disc
<b>Rear Derailleur</b>	SRAM NX Eagle
<b>Chain</b>	SRAM NX Eagle 12-Speed
<b>Wheels</b>	Mach1 Klixx 23c Tubeless Ready
<b>Cassette</b>	SRAM NX PG-1230 Eagle 11-50t 12-Speed
<b>Tyres</b>	Maxxis Ikon 2.20" FB 60 TPI Dual Maxxis Ikon 2.20" TLR 120 TPI 3C Exo
<b>Pedals</b>	N/A
<b>Seatpost</b>	Orbea OC-II 27.2x400mm Orbea Digit 27.2x400mm
<b>Saddle</b>	Selle Royal Seta Sport Selle Italia SL X-Cross Flow

Selle Italia Lady Flow

## ALMA H50 *MyO<sub>2.0</sub>*

Code	J227,J224		
Size	Crank	Stem	Handlebar
S-27	170	70	720
S-29	170	70	720
M-27	175	70	720
M-29	175	70	720
L-29	175	90	720
XL-29	175	110	720



<b>Frame</b>	Orbea Alma Hydro 2019 Boost Triple Butted 4X4 Taper PF Race
<b>Fork</b>	RockShox 30 Silver TK 100 Air Remote QR
<b>Crankset</b>	OC-Custom PW Claw-551-TT 26x36t Race Face Aeffect Cinch 32t (11-46T Cass)
<b>Headset</b>	FSA 1-1/8 - 1-1/2" Integrated
<b>Handlebar</b>	Orbea OC-II Flat 720mm Race Face Ride Flat 710mm Kit (Bar+S-tem+Spost)
<b>Stem</b>	Orbea OC-II
<b>Shifters</b>	Shimano SLX M7000
<b>Brakes</b>	Shimano MT201 Hydraulic Disc Shimano MT501 BR500 Hydraulic Disc
<b>Rear Derailleur</b>	Shimano SLX M7000 GS Shadow Plus Direct Mount



<b>Front Derailleur</b>	Shimano SLX M7020
<b>Chain</b>	Shimano HG601-11
<b>Wheels</b>	Mach1 Klixx 23c Tubeless Ready
<b>Cassette</b>	Sun Race 11-42t 11-Speed
<b>Tyres</b>	Maxxis Ikon 2.20" FB 60 TPI Dual Maxxis Ikon 2.20" TLR 120 TPI 3C Exo
<b>Pedals</b>	N/A
<b>Seatpost</b>	Orbea OC-II 27.2x400mm Orbea Digit 27.2x400mm
<b>Saddle</b>	Selle Royal Seta Sport Selle Italia SL X-Cross Flow Selle Italia Lady Flow



## VERY SERIOUS **FUN**

Technologically speaking, MX bikes are especially innovative. Below, we'll explain the technological concepts and details behind Orbea's MX line. They're real fun machines.

**MX**





## MX TECH



- 01 ORBEA TUBE SHAPING
- 02 INTERNAL CABLE ROUTING
- 03 DURABLE, SOLID, RELIABLE
- 04 COMFORT
- 05 COMPATIBILITY
- 06 HYDRAULIC BRAKES



### ORBEA TUBE SHAPING

The AL6061 frame tubing of the MX is carefully shaped and manipulated to put strength where it's needed without unnecessary weight.

### DURABLE, SOLID, RELIABLE

MX is loaded with features that help ensure longer life: Sealed headset and BB bearings, a replaceable derailleur hanger, painted and assembled in the EU, all with the Orbea Lifetime Warranty.

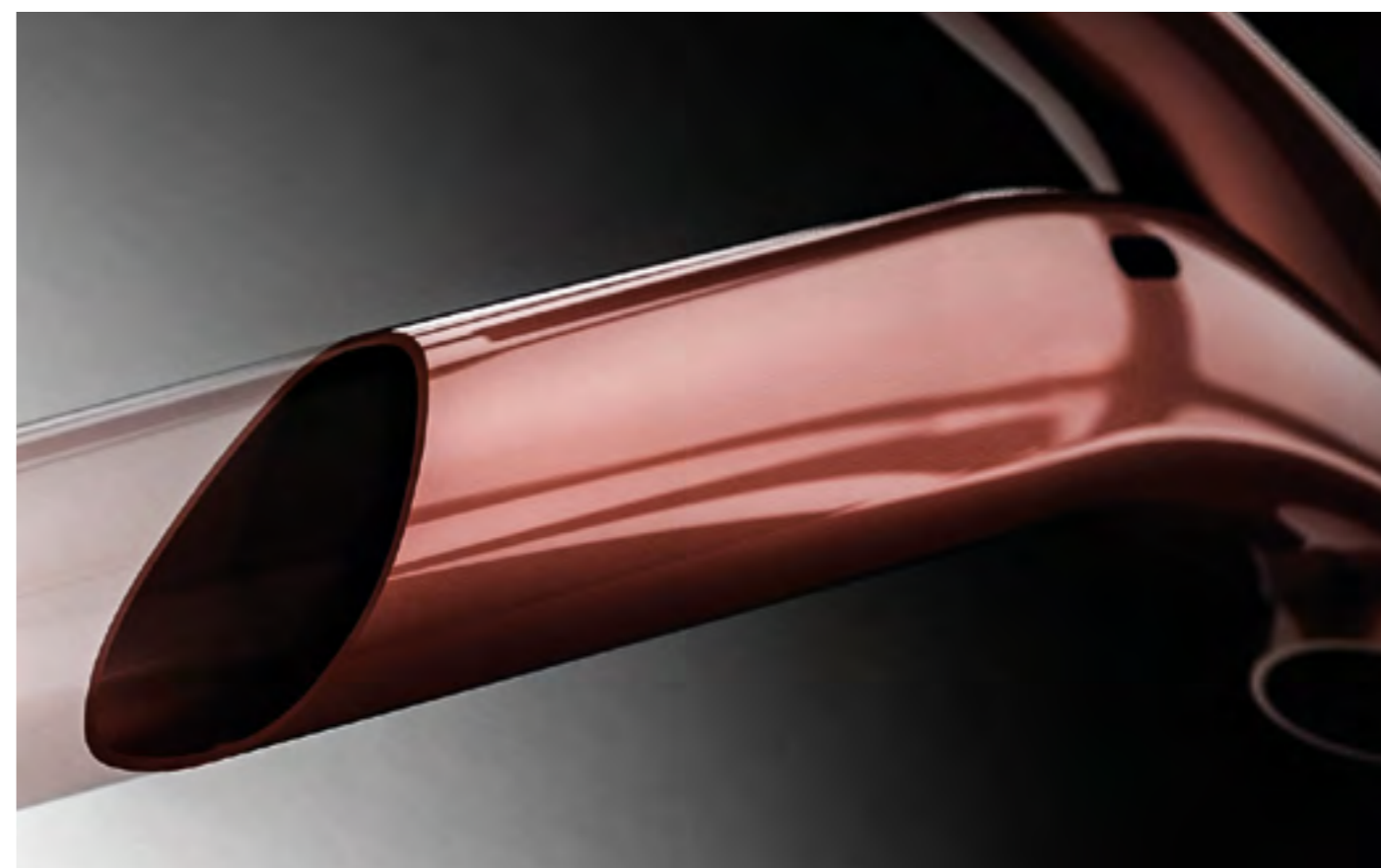

## COMFORT

The six sizes are available in different wheel sizes (SM, MD, LG in 27.5 and MD, LG, XL in 29) to offer the best blend of efficiency, comfort and fun for any rider. MX is optimized for lateral stiffness without losing vertical compliance, and 2.35 tires mounted on wide (23mm internal) rims deliver control and a smooth ride over all kinds of terrain.

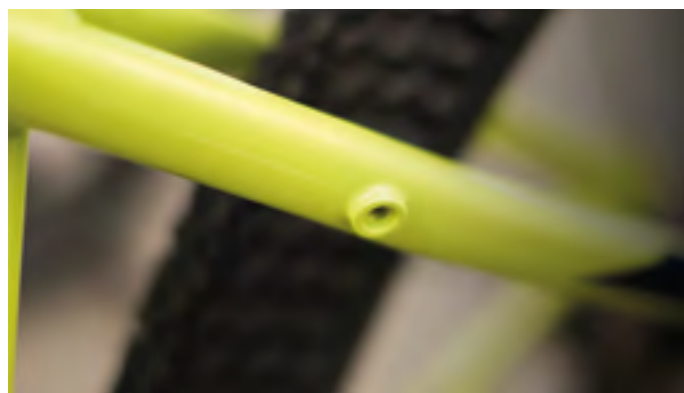

## COMPATIBILITY

MX is compatible with your riding style. The patented Orbea Digit quick-adjust seat post fits perfectly, and mounting points for racks make increasing carrying capacity a breeze.

## INTERNAL CABLE ROUTING

Internal Cable Routing not only gives a cleaner appearance, it takes advantage of full-length cable housing for great performance with lower maintenance.



## HYDRAULIC BRAKES

MX only uses hydraulic disc brake systems because of their power, reliability and low maintenance. Better lever feel and increased stopping power will make your rides safer and more fun.

# MX

SIZES	S - 27.5"	M - 27.5"	M - 29"	L - 27.5"	L - 29"	XL - 29"
1 - Seat Tube (C-T)	388	430	430	460	470	540
2 - Top Tube (EFF)	537	564	559	583	578	618
3 - Head Tube	102	108	104	118	115	138
4 - Chainstay	440	440	450	440	450	450
5 - BB Height	312,5	312,5	305	312,5	305	305
6 - BB Drop	45	45	65	45	65	65
7 - Wheelbase	1059	1075	1078	1098	1098	1139
8 - Head Angle	69°	70°	70°	70°	70°	70°
9 - Seat Angle	74°	74°	74°	74°	74°	74°
10 - Standover	790,5	815,67	823,17	834,59	837,09	881,73
11 - Reach	370	394	397	413	397	430
12 - Stack	583	593	623	602	633	655
13 - Fork Length	490	490	506	490	506	506

HEIGHT (cm)	HEIGHT (in)	SIZE
155-160	61.1"-63.0"	S- 27.5"
165-180	65.0"-70.9"	M- 27.5"
164-180	64.6"-70.9"	M- 29"
178-190	70.1"-74.8"	L- 27.5"
178-190	70.1"-74.8"	L- 29"
185-200	72.8"-78.7"	XL- 29"

- Silver-Black (Gloss-Matt) **DC**
- Black-Orange (Matt-Gloss) **R1**
- Black-Turquoise-Red (Matt) **R3**
- Pistachio-Black (Gloss) **R4**
- Red-Black (Gloss) **R5**

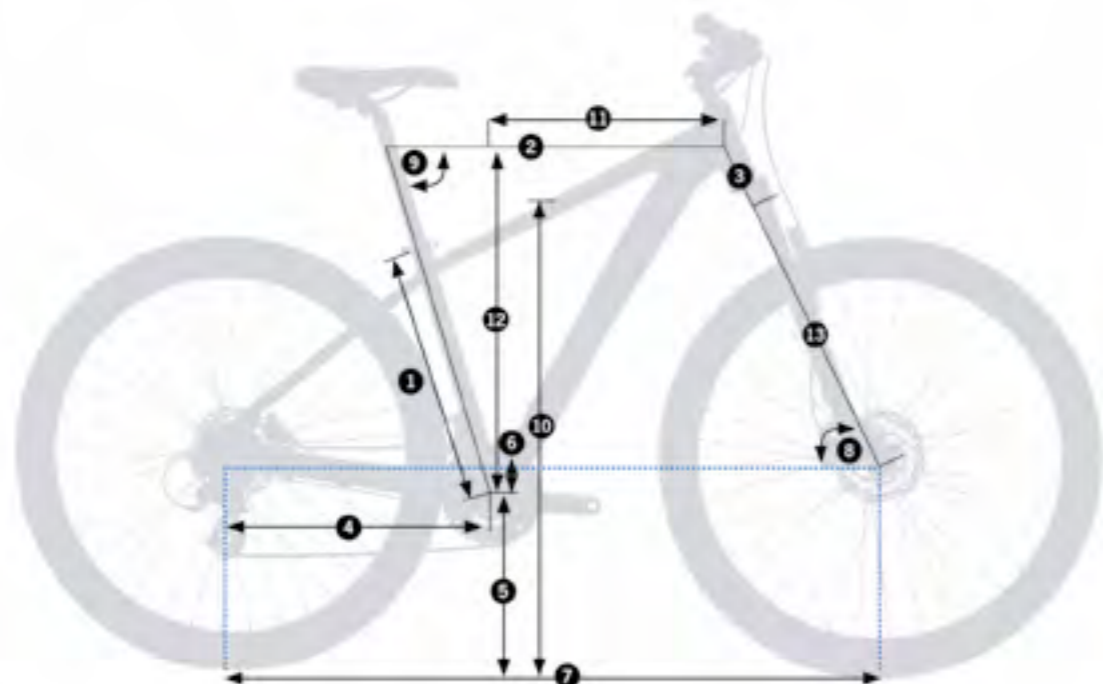

# MX 10

Code	J211,J205		
Size	Crank	Stem	Handlebar
S-27	170	70	720
M-27	170	70	720
M-29	170	70	720
L-27	175	70	720
L-29	175	70	720
XL-29	175	110	720



<b>Frame</b>	Orbea MX Alu only disc
<b>Fork</b>	RockShox 30 Silver TK 100 Air Remote QR
<b>Crankset</b>	Prowheel Zephyr-501-TT 22x36t
<b>Headset</b>	1-1/8" Semi-Integrated
<b>Handlebar</b>	Orbea OC-I Riser 720mm
<b>Stem</b>	Orbea OC-II
<b>Shifters</b>	Shimano Deore M6000
<b>Brakes</b>	Shimano MT201 Hydraulic Disc
<b>Rear Derailleur</b>	Shimano XT SGS Shadow Direct Mount
<b>Front Derailleur</b>	Shimano Deore M6025 31,8mm
<b>Chain</b>	Fsa Team Issue
<b>Wheels</b>	Orbea Black Rock 23c Disc
<b>Cassette</b>	Shimano HG50 11-36t 10-Speed
<b>Tyres</b>	Kenda K1153 2,35" 30TPI



<b>Pedals</b>	VPE-537 Black
<b>Seatpost</b>	Orbea OC-I 27.2x400mm
<b>Saddle</b>	Selle Royal 2062 HRN

# MX 20

Code	J210,J204		
Size	Crank	Stem	Handlebar
S-27	170	70	720
M-27	170	70	720
M-29	170	70	720
L-27	175	70	720
L-29	175	70	720
XL-29	175	110	720



<b>Frame</b>	Orbea MX Alu only disc
<b>Fork</b>	SR Suntour XCR RL-Coil 100mm QR
<b>Crankset</b>	Prowheel Zephyr-501-TT 22x36t
<b>Headset</b>	1-1/8" Semi-Integrated
<b>Handlebar</b>	Orbea OC-I Riser 720mm
<b>Stem</b>	Orbea OC-II
<b>Shifters</b>	Shimano Deore M6000
<b>Brakes</b>	Shimano MT201 Hydraulic Disc
<b>Rear Derailleur</b>	Shimano XT SGS Shadow Direct Mount
<b>Front Derailleur</b>	Shimano Deore M6025 31,8mm
<b>Chain</b>	Fsa Team Issue
<b>Wheels</b>	Orbea Black Rock 23c Disc
<b>Cassette</b>	Shimano HG50 11-36t 10-Speed
<b>Tyres</b>	Kenda K1153 2,35" 30TPI

<b>Pedals</b>	VPE-537 Black
<b>Seatpost</b>	Orbea OC-I 27.2x400mm
<b>Saddle</b>	Selle Royal 2062 HRN



## MX 30

<b>Code</b>	J209,J203		
<b>Size</b>	<b>Crank</b>	<b>Stem</b>	<b>Handlebar</b>
S-27	170	70	720
M-27	170	70	720
M-29	170	70	720
L-27	170	70	720
L-29	170	70	720
XL-29	170	110	720



<b>Frame</b>	Orbea MX Alu only disc
<b>Fork</b>	SR Suntour XCM RL-Coil 100mm QR
<b>Crankset</b>	Prowheel Marvel-951-TT 22x30x40t
<b>Headset</b>	1-1/8" Semi-Integrated
<b>Handlebar</b>	Orbea OC-I Riser 720mm
<b>Stem</b>	Orbea OC-II
<b>Shifters</b>	Shimano Deore M6000
<b>Brakes</b>	Shimano MT200 Hydraulic Disc
<b>Rear Derailleur</b>	Shimano Deore M6000 SGS Shadow Plus Direct Mount
<b>Front Derailleur</b>	Shimano Deore M611 31.8mm
<b>Chain</b>	Fsa Team Issue
<b>Wheels</b>	Orbea Black Rock 23c Disc
<b>Cassette</b>	Shimano HG50 11-36t 10-Speed

<b>Tyres</b>	Kenda K1153 2,35" 30TPI
<b>Pedals</b>	VPE-537 Black
<b>Seatpost</b>	Orbea OC-I 27.2x400mm
<b>Saddle</b>	Selle Royal 2062 HRN

## MX 40

<b>Code</b>	J208,J202		
<b>Size</b>	<b>Crank</b>	<b>Stem</b>	<b>Handlebar</b>
S-27	170	70	720
M-27	170	70	720
M-29	170	70	720
L-27	175	70	720
L-29	175	70	720
XL-29	175	110	720



<b>Frame</b>	Orbea MX Alu only disc
<b>Fork</b>	SR Suntour XCM RL-Coil 100mm QR
<b>Crankset</b>	Shimano MT100 22x30x40t
<b>Headset</b>	1-1/8" Semi-Integrated
<b>Handlebar</b>	Orbea OC-I Riser 720mm
<b>Stem</b>	Orbea OC-II
<b>Shifters</b>	Shimano Altus M2000
<b>Brakes</b>	Shimano MT200 Hydraulic Disc
<b>Rear Derailleur</b>	Shimano Altus M2000 SGS Shadow
<b>Front Derailleur</b>	Shimano Altus M2000
<b>Chain</b>	Shimano HG53 9-Speed
<b>Wheels</b>	Orbea Black Rock 23c Disc
<b>Cassette</b>	Shimano HG200 11-36 9-Speed
<b>Tyres</b>	Kenda K1153 2,35" 30TPI

<b>Pedals</b>	VPE-537 Black
<b>Seatpost</b>	Orbea OC-I 27.2x400mm
<b>Saddle</b>	Selle Royal 2062 HRN

## MX 50

<b>Code</b>	J207,J201		
<b>Size</b>	<b>Crank</b>	<b>Stem</b>	<b>Handlebar</b>
S-27	170	70	720
M-27	170	70	720
M-29	170	70	720
L-27	170	70	720
L-29	170	70	720
XL-29	170	70	720



<b>Frame</b>	Orbea MX Alu only disc
<b>Fork</b>	SR Suntour XCT 30 Coil 100mm QR
<b>Crankset</b>	Shimano TY301 24x34x42t
<b>Headset</b>	1-1/8" Semi-Integrated
<b>Handlebar</b>	Orbea OC Riser 720mm
<b>Stem</b>	Orbea OC
<b>Shifters</b>	Shimano M310
<b>Brakes</b>	Shimano MT200 Hydraulic Disc
<b>Rear Derailleur</b>	Shimano Altus M310
<b>Front Derailleur</b>	Shimano Altus M313 31.8mm
<b>Chain</b>	KMC X8
<b>Wheels</b>	Mach1 ER20 19c
<b>Cassette</b>	Shimano HG200 12-32t 8-Speed
<b>Tyres</b>	Kenda K1153 2,35" 22TPI

<b>Pedals</b>	VPE-537 Black
<b>Seatpost</b>	Orbea OC 27.2x400mm
<b>Saddle</b>	Selle Royal 2073

## MX 60

<b>Code</b>	J206,J200		
<b>Size</b>	<b>Crank</b>	<b>Stem</b>	<b>Handlebar</b>
S-27	170	70	720
M-27	170	70	720
M-29	170	70	720
L-27	170	70	720
L-29	170	70	720
XL-29	170	70	720



<b>Frame</b>	Orbea MX Alu only disc
<b>Fork</b>	SR Suntour XCE 28 Coil 100mm QR
<b>Crankset</b>	Shimano TY301 24x34x42t
<b>Headset</b>	1-1/8" Semi-Integrated
<b>Handlebar</b>	Orbea OC Riser 720mm
<b>Stem</b>	Orbea OC
<b>Shifters</b>	Shimano M310
<b>Brakes</b>	Shimano MT200 Hydraulic Disc
<b>Rear Derailleur</b>	Shimano TY300
<b>Front Derailleur</b>	Shimano Altus M313 31.8mm
<b>Chain</b>	Z7 GYBR
<b>Wheels</b>	Mach1 ER20 19c
<b>Cassette</b>	Shimano HG200 12-32t 7-Speed
<b>Tyres</b>	Kenda K1153 2,35" 22TPI

<b>Pedals</b>	VPE-537 Black
<b>Seatpost</b>	Orbea OC 27.2x400mm
<b>Saddle</b>	Selle Royal 2073

## MX ENTRANCE

SIZES	S - 27.5"	M - 27.5"	L - 29"
1 - Seat Tube (C-T)	409	445	450
2 - Top Tube (EFF)	550	574	569
3 - Head Tube	105	113	109
4 - Chainstay	440	440	450
5 - BB Height	300	300	305
6 - BB Drop	45	45	65
7 - Wheelbase	1067	1086	1088
8 - Head Angle	69.5°	70°	70°
9 - Seat Angle	74°	74°	74°
11 - Reach	382	403	389
12 - Stack	588	597	627
13 - Fork Length	490	490	506

HEIGHT (cm)	HEIGHT (in)	SIZE
160-170	63.0"-66.9"	S- 27.5"
170-180	66.9"-70.9"	M- 27.5"
180-190	70.9"-74.8"	L- 29"

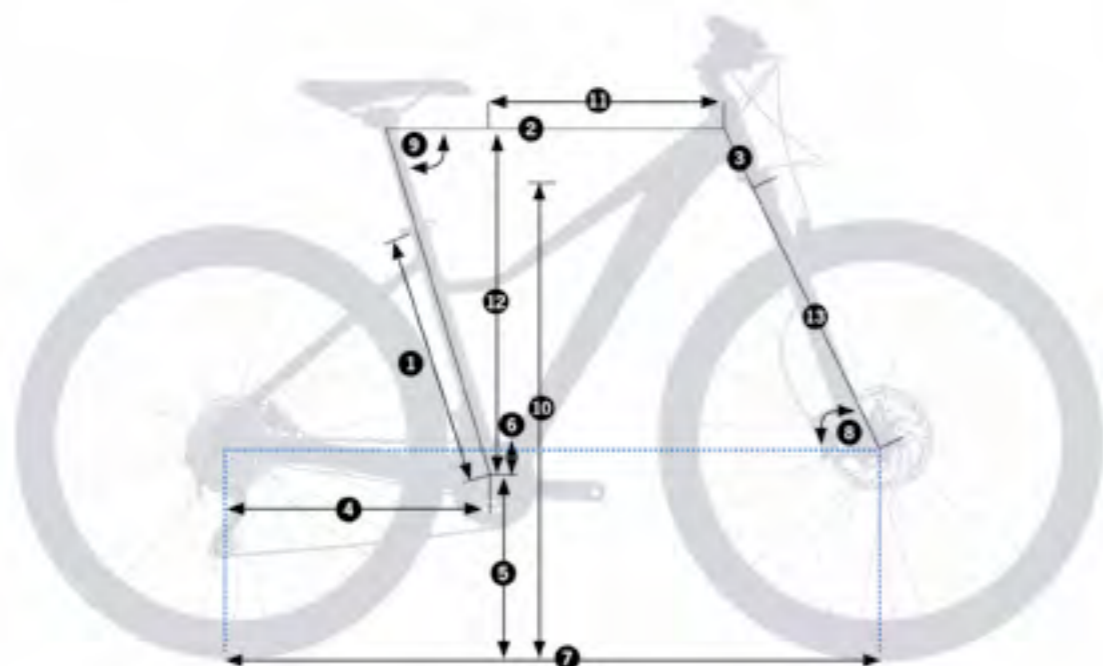

## MX ENT 10

Code	J223,J217		
Size	Crank	Stem	Handlebar
S-27	170	70	720
M-27	170	70	720
L-29	175	70	720



<b>Frame</b>	Orbea MX Entrance only disc
<b>Fork</b>	RockShox 30 Silver TK 100 Air Remote QR
<b>Crankset</b>	Prowheel Zephyr-501-TT 22x36t
<b>Headset</b>	1-1/8" Semi-Integrated
<b>Handlebar</b>	Orbea OC-I Riser 720mm
<b>Stem</b>	Orbea OC-II
<b>Shifters</b>	Shimano Deore M6000
<b>Brakes</b>	Shimano MT201 Hydraulic Disc
<b>Rear Derailleur</b>	Shimano XT SGS Shadow Direct Mount
<b>Front Derailleur</b>	Shimano Deore M6025 31,8mm
<b>Chain</b>	Fsa Team Issue
<b>Wheels</b>	Orbea Black Rock 23c Disc
<b>Cassette</b>	Shimano HG50 11-36t 10-Speed
<b>Tyres</b>	Kenda K1153 2,35" 30TPI



<b>Pedals</b>	VPE-537 Black
<b>Seatpost</b>	Orbea OC-I 27.2x400mm
<b>Saddle</b>	Selle Royal 2062 HRN

## MX ENT 20

Code	J222,J216		
Size	Crank	Stem	Handlebar
S-27	170	70	720
M-27	170	70	720
L-29	175	70	720



<b>Frame</b>	Orbea MX Entrance only disc
<b>Fork</b>	SR Suntour XCR RL-Coil 100mm QR
<b>Crankset</b>	Prowheel Zephyr-501-TT 22x36t
<b>Headset</b>	1-1/8" Semi-Integrated
<b>Handlebar</b>	Orbea OC-I Riser 720mm
<b>Stem</b>	Orbea OC-II
<b>Shifters</b>	Shimano Deore M6000
<b>Brakes</b>	Shimano MT201 Hydraulic Disc
<b>Rear Derailleur</b>	Shimano XT SGS Shadow Direct Mount
<b>Front Derailleur</b>	Shimano Deore M6025 31,8mm
<b>Chain</b>	Fsa Team Issue
<b>Wheels</b>	Orbea Black Rock 23c Disc
<b>Cassette</b>	Shimano HG50 11-36t 10-Speed
<b>Tyres</b>	Kenda K1153 2,35" 30TPI



<b>Pedals</b>	VPE-537 Black
<b>Seatpost</b>	Orbea OC-I 27.2x400mm
<b>Saddle</b>	Selle Royal 2062 HRN

## MX ENT 30

Code	J221,J215		
Size	Crank	Stem	Handlebar
S-27	170	70	720
M-27	170	70	720
L-29	170	70	720



<b>Frame</b>	Orbea MX Entrance only disc
<b>Fork</b>	SR Suntour XCM RL-Coil 100mm QR
<b>Crankset</b>	Prowheel Marvel-951-TT 22x30x40t
<b>Headset</b>	1-1/8" Semi-Integrated
<b>Handlebar</b>	Orbea OC-I Riser 720mm
<b>Stem</b>	Orbea OC-II
<b>Shifters</b>	Shimano Deore M6000
<b>Brakes</b>	Shimano MT200 Hydraulic Disc
<b>Rear Derailleur</b>	Shimano Deore M6000 SGS Shadow Plus Direct Mount
<b>Front Derailleur</b>	Shimano Deore M611 31.8mm
<b>Chain</b>	Fsa Team Issue
<b>Wheels</b>	Orbea Black Rock 23c Disc
<b>Cassette</b>	Shimano HG50 11-36t 10-Speed

<b>Tyres</b>	Kenda K1153 2,35" 30TPI
<b>Pedals</b>	VPE-537 Black
<b>Seatpost</b>	Orbea OC-I 27.2x400mm
<b>Saddle</b>	Selle Royal 2062 HRN

## MX ENT 40

Code	J220,J214		
Size	Crank	Stem	Handlebar
S-27	170	70	720
M-27	170	70	720
L-29	175	70	720



<b>Frame</b>	Orbea MX Entrance only disc
<b>Fork</b>	SR Suntour XCM RL-Coil 100mm QR
<b>Crankset</b>	Shimano MT100 22x30x40t
<b>Headset</b>	1-1/8" Semi-Integrated
<b>Handlebar</b>	Orbea OC-I Riser 720mm
<b>Stem</b>	Orbea OC-II
<b>Shifters</b>	Shimano Altus M2000
<b>Brakes</b>	Shimano MT200 Hydraulic Disc
<b>Rear Derailleur</b>	Shimano Altus M2000 SGS Shadow
<b>Front Derailleur</b>	Shimano Altus M2000
<b>Chain</b>	Shimano HG53 9-Speed
<b>Wheels</b>	Orbea Black Rock 23c Disc
<b>Cassette</b>	Shimano HG200 11-36 9-Speed
<b>Tyres</b>	Kenda K1153 2,35" 30TPI

<b>Pedals</b>	VPE-537 Black
<b>Seatpost</b>	Orbea OC-I 27.2x400mm
<b>Saddle</b>	Selle Royal 2062 HRN

## MX ENT 50

Code	J219,J213		
Size	Crank	Stem	Handlebar
S-27	170	70	720
M-27	170	70	720
L-29	170	70	720



<b>Frame</b>	Orbea MX Entrance only disc
<b>Fork</b>	SR Suntour XCT 30 Coil 100mm QR
<b>Crankset</b>	Shimano TY301 24x34x42t
<b>Headset</b>	1-1/8" Semi-Integrated
<b>Handlebar</b>	Orbea OC Riser 720mm
<b>Stem</b>	Orbea OC
<b>Shifters</b>	Shimano M310
<b>Brakes</b>	Shimano MT200 Hydraulic Disc
<b>Rear Derailleur</b>	Shimano Altus M310
<b>Front Derailleur</b>	Shimano Altus M313 31.8mm
<b>Chain</b>	KMC X8
<b>Wheels</b>	Mach1 ER20 19c
<b>Cassette</b>	Shimano HG200 12-32t 8-Speed
<b>Tyres</b>	Kenda K1153 2,35" 22TPI

<b>Pedals</b>	VPE-537 Black
<b>Seatpost</b>	Orbea OC 27.2x400mm
<b>Saddle</b>	Selle Royal 2073

## MX ENT 60

Code	J218,J212		
Size	Crank	Stem	Handlebar
S-27	170	70	720
M-27	170	70	720
L-29	170	70	720



<b>Frame</b>	Orbea MX Entrance only disc
<b>Fork</b>	SR Suntour XCE 28 Coil 100mm QR
<b>Crankset</b>	Shimano TY301 24x34x42t
<b>Headset</b>	1-1/8" Semi-Integrated
<b>Handlebar</b>	Orbea OC Riser 720mm
<b>Stem</b>	Orbea OC
<b>Shifters</b>	Shimano M310
<b>Brakes</b>	Shimano MT200 Hydraulic Disc
<b>Rear Derailleur</b>	Shimano TY300
<b>Front Derailleur</b>	Shimano Altus M313 31.8mm
<b>Chain</b>	Z7 GYBR
<b>Wheels</b>	Mach1 ER20 19c
<b>Cassette</b>	Shimano HG200 12-32t 7-Speed
<b>Tyres</b>	Kenda K1153 2,35" 22TPI

<b>Pedals</b>	VPE-537 Black
<b>Seatpost</b>	Orbea OC 27.2x400mm
<b>Saddle</b>	Selle Royal 2073



# URBAN

KATU  
NEW OPTIMA  
CARPE  
VECTOR



## UNIQUELY UNIVERSAL

The world is continually evolving. Our customs, spaces and needs have reached a turning point. Katu is a platform that is especially sensitive to the new way in which we move about the city, designed for both those who want to get started in urban cycling and those who are already very experienced or even professionals. Practicality, style, environmental friendliness and urban coexistence are the main pillars of this new product that we introduce to you in different electric and non-electric versions. Enjoy discovering everything about the Katu, from the general concept to how we've taken care of every last detail.

**KATU**





**URBAN ESSENCE**

- / Front and Rear Lights
- / Reflective Tires
- / Comfortable Saddle
- / Frame Lock\*
- / Kickstand

**KATU IS FOR EVERYONE**

- / One Size Fits All
- / Universal Product Range
- / Adjustable System
- / Eight Colors

**KATU IS SOLID AND DURABLE**

- / Full Sized Bike Ride Quality
- / Aluminium Frame
- / 20" Wheels
- / Orbea Lifetime Warranty



**KATU IS CAPABLE**

- / Front Basket Included
- / Rear Basket Optional
- / Child Seat Compatible

<<

# KATU

SIZES	U
1 - Seat Tube (C-T)	458
2 - Top Tube (EFF)	576
3 - Head Tube	250
4 - Chainstay	437
5 - BB Height	276
6 - BB Drop	26
7 - Wheelbase	1082
8 - Head Angle	68.7°
9 - Seat Angle	71.3°
10 - Standover	650
11 - Reach	402
12 - Stack	523
13 - Fork Length	350

- Magnetic Black (Matt) T1
- Supergreen (Matt) T2
- Bone White (Matt) T3
- Fresh Green (Matt) T4
- Nordic Blue (Matt) T5
- Etheric Silver (Matt) T6
- Bordeaux (Matt) T7
- Almost Red (Matt) T8

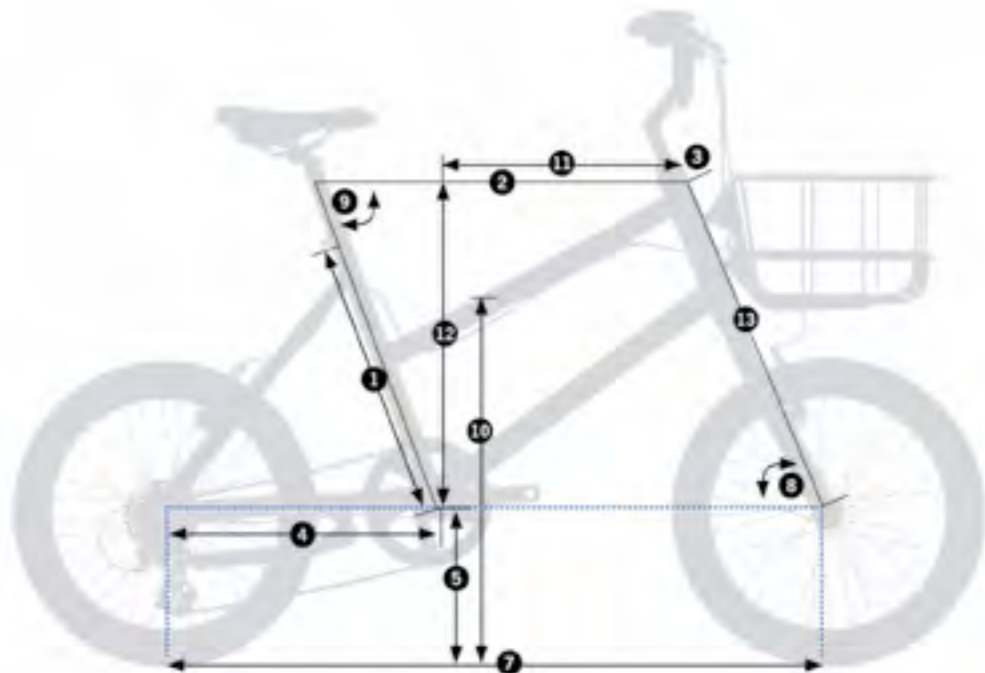

# KATU 20

Code	J419		
Size	Crank	Stem	Handlebar
20	170	150	660



<b>Frame</b>	KATU 20"
<b>Fork</b>	Orbea Katu
<b>Crankset</b>	Prowheel PRO-648 48t(170) Chainguard single
<b>Headset</b>	1-1/8" Semi-Integrated
<b>Handlebar</b>	Orbea City Riser Alu 660mm
<b>Stem</b>	Orbea Alu
<b>Shifters</b>	Shimano SL-C6000 Nexus 8-Speed
<b>Brakes</b>	Shimano MT200 Hydraulic Disc
<b>Chain</b>	KMC Single-Speed
<b>Wheels</b>	Orbea Web Disc
<b>Cassette</b>	Shimano Nexus 18t
<b>Tyres</b>	Kenda 841 20x2.25 Reflex
<b>Pedals</b>	VP-615 Black



<b>Seatpost</b>	Orbea OC 31.6x400mm
<b>Saddle</b>	Selle Royal Milo Plus DR
<b>Front basket</b>	Aluminium Front Basket
<b>Mudguard</b>	SKS 20" 60mm
<b>Front light</b>	Joss Spanninga Kendo XDAS Dinamo
<b>Rear light</b>	Spanninga Pixeo
<b>Dynamo</b>	Shimano DH-3D37-NT, 6V Dynamo 3.0W
<b>Quick stand</b>	Ursus Big Foot double central alloy

# KATU 30

Code	J418		
Size	Crank	Stem	Handlebar
30	170	150	660



<b>Frame</b>	KATU 30"
<b>Fork</b>	Orbea Katu
<b>Crankset</b>	Prowheel PRO-648 48t(170) Chainguard single
<b>Headset</b>	1-1/8" Semi-Integrated
<b>Handlebar</b>	Orbea City Riser Alu 660mm
<b>Stem</b>	Orbea Alu
<b>Shifters</b>	Sturmey Archer TSC50 5-Speed Twist
<b>Brakes</b>	Shimano MT200 Hydraulic Disc
<b>Chain</b>	KMC Single-Speed
<b>Wheels</b>	Orbea Web Disc
<b>Cassette</b>	Sturmey Archer CSIRW 18t
<b>Tyres</b>	Kenda 841 20x2,25" Reflective Logo
<b>Pedals</b>	VPE-537 Black



<b>Seatpost</b>	Orbea OC 31.6x400mm
<b>Saddle</b>	Selle Royal One 6007 DR
<b>Front basket</b>	Aluminium Front Basket
<b>Mudguard</b>	SKS 20" 60mm
<b>Front light</b>	Joss Spanninga Kendo XDAS Dinamo
<b>Rear light</b>	Spanninga Pixeo
<b>Dynamo</b>	Shimano DH-3D37-NT, 6V Dynamo 3.0W
<b>Quick stand</b>	Ursus Big Foot double central alloy

## KATU 40

Code	J417		
Size	Crank	Stem	Handlebar
40	170	150	660



Frame	KATU 20"
Fork	KATU 20"
Crankset	Prowheel PRO-648 48t(170) Chainguard single
Headset	1-1/8" Semi-Integrated
Handlebar	Orbea City Riser Alu 660mm
Stem	Orbea Alu
Shifters	Sturmey Archer TSC50 5-Speed Twist
Brake levers	Orbea Trekking Alu 4-finger
Brakes	Orbea V-Brake
Chain	KMC Single-Speed
Wheels	Orbea Scorpion DW
Cassette	Sturmey Archer CSIRW 18t
Hub	Safety Lock

Tyres	Kenda 841 20x2,25" Reflective Logo
Pedals	VPE-537 Black
Seatpost	Orbea OC 31.6x400mm
Saddle	Selle Royal One 6007 DR
Front basket	Aluminium Front Basket
Mudguard	SKS 20" 60mm
Front light	Joss Spanninga Galeo XB Battery
Rear light	PIXEO
Quick stand	Ursus Big Foot double central alloy

## KATU 50

Code	J416		
Size	Crank	Stem	Handlebar
50	170	150	660



Frame	KATU 20"
Fork	KATU 20"
Crankset	Prowheel PRO-648 48t(170) Chainguard single
Headset	1-1/8" Semi-Integrated
Handlebar	Orbea City Riser Alu 660mm
Stem	Orbea Alu
Shifters	Shimano SL-RS36-7R Tourney
Brake levers	Orbea Trekking Alu 4-finger
Brakes	Orbea V-Brake
Rear Derailleur	Shimano Altus M310
Chain	Z7 GYBR
Wheels	Orbea Scorpion DW
Cassette	Shimano HG200 12-32t 7-Speed

Hub	Safety Lock
Tyres	Kenda 841 20x2,25" Reflective Logo
Pedals	VPE-537 Black
Seatpost	Orbea OC 31.6x400mm
Saddle	Selle Royal One 6007 DR
Front basket	Aluminium Front Basket
Quick stand	Ursus Mooi adjust



## IT'S ALL ABOUT **BALANCE**

Optima is an apparently "normal" bicycle, but both the architecture and the ergonomics of the new Optima are innovative.

NEW **OPTIMA**



### VERSATILITY

#### COMFORTABLE

- / Easy Access
- / Balanced City Geometry
- / Comfortable Grips and Saddles
- / Weatherproof
- / Wide Gear Ratio
- / Lightweight Alloy Frame
- / Big Tires

#### URBAN ESSENCE

- / Lights, Front and Rear
- / Frame Lock\*
- / Fenders + Chainguard
- / Kickstand
- / Orbea Lifetime Warranty
- / Colorful Frames and Details

>>



# OPTIMA

SIZES	S	M	L
1 - Seat Tube (C-T)	405	450	500
2 - Top Tube (EFF)	625	648	693
3 - Head Tube	190	240	270
4 - Chainstay	510	510	510
5 - BB Height	272,5	272,5	272,5
6 - BB Drop	95	95	95
7 - Wheelbase	1163	1187	1233
8 - Head Angle	70°	70°	70°
9 - Seat Angle	72°	72°	72°
11 - Reach	397	405	440
12 - Stack	662	709	737
13 - Fork Length	433	433	433

HEIGHT (cm)	HEIGHT (in)	SIZE
150-165	59.1"-65.0"	S
165-180	65.0"-70.9"	M
180-200	70.9"-78.7"	L

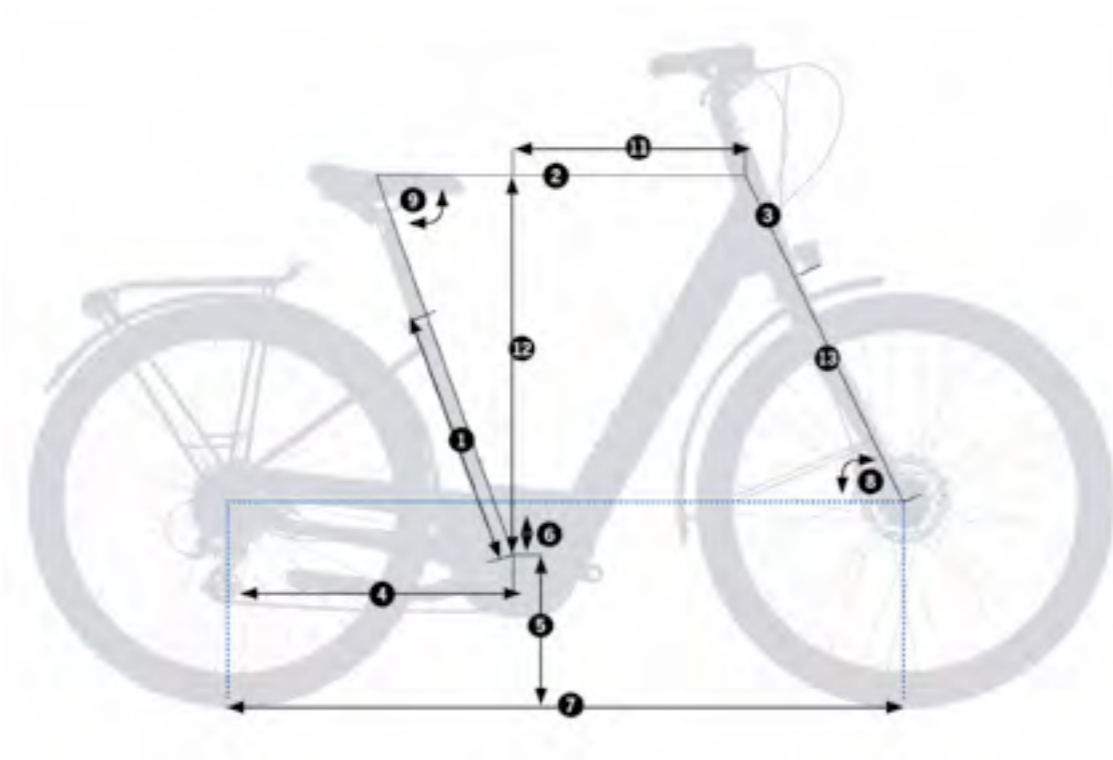

# OPTIMA A20

Code	J428		
Size	Crank	Stem	Handlebar
S	152	60	640
M	152	60	640
L	152	60	640



<b>Frame</b>	Orbea Optima Hydroformed Alloy
<b>Fork</b>	Optima 400mm Hi-Ten Post mount
<b>Crankset</b>	Prowheel PRA-105 42t
<b>Headset</b>	1-1/8" Semi-Integrated
<b>Handlebar</b>	Orbea City Riser Alu 640mm
<b>Stem</b>	Orbea TDS-D617
<b>Shifters</b>	Shimano M310
<b>Brakes</b>	Shimano MT200 Hydraulic Disc
<b>Rear Derailleur</b>	Shimano Altus M310
<b>Chain</b>	KMC X8
<b>Wheels</b>	Orbea Scorpion DW
<b>Cassette</b>	Shimano HG200 12-32t 8-Speed
<b>Tyres</b>	Kenda 1172 700x50c
<b>Pedals</b>	VP-856 Black



<b>Seatpost</b>	Orbea OC 31.6x400mm
<b>Saddle</b>	Selle Royal Milo Plus DR
<b>Rear carrier</b>	Orbea Optima hidden stays
<b>Mudguard</b>	Orbea SKS EDGE Alu C56R
<b>Front light</b>	Joss Spanninga Kendo XDAS Dinamo
<b>Rear light</b>	Joss Spanninga Lineo XDS Dinamo
<b>Dynamo</b>	Shimano DH-3D37-NT, 6V Dynamo 3.0W
<b>Chainguard</b>	Orbea Optima
<b>Quick stand</b>	Ursus Power single central adjustable

# OPTIMA A30

Code	J427		
Size	Crank	Stem	Handlebar
S	152	60	640
M	152	60	640
L	152	60	640



<b>Frame</b>	Orbea Optima Hydroformed Alloy
<b>Fork</b>	Optima 400mm Hi-Ten Post mount
<b>Crankset</b>	Prowheel PRA-105 42t
<b>Headset</b>	1-1/8" Semi-Integrated
<b>Handlebar</b>	Orbea City Riser Alu 640mm
<b>Stem</b>	Orbea TDS-D617
<b>Shifters</b>	Shimano M310
<b>Brake levers</b>	Orbea Trekking Alu 4-finger
<b>Brakes</b>	Shimano TX805 Mechanical Disc
<b>Rear Derailleur</b>	Shimano Altus M310
<b>Chain</b>	KMC X8
<b>Wheels</b>	Orbea Scorpion DW
<b>Cassette</b>	Shimano HG200 12-32t 8-Speed
<b>Tyres</b>	Kenda 1172 700x50c

<b>Pedals</b>	VP-856 Black
<b>Seatpost</b>	Orbea OC 31.6x400mm
<b>Saddle</b>	Selle Royal Milo Plus DR
<b>Rear carrier</b>	Orbea Optima hidden stays
<b>Mudguard</b>	Orbea SKS EDGE Alu C56R
<b>Chainguard</b>	Orbea Optima
<b>Quick stand</b>	Ursus Power single central adjustable





## **SEIZE** THE DAY, ANY DAY

You have a style, and you know what fits. Combine it in a certain way with the Carpe. These bikes are lightweight, versatile, and comfortable. There is beauty when you feel the handlebars, the smoothness of the gear change, or the harmony of its parts. You'll like your city and its streets even more while moving on two wheels. Nobody can stop you.

These are the bikes that give you the freedom you've been waiting for. Throw a leg over and enjoy.

**CARPE**



### CARPE IS FUN

/ Colorful Frames and Rims.

/ Balanced Sport Geometry

### CARPE IS QUALITY

/ Disc Only\*

/ Orbea Lifetime Warranty

/ High Quality Groupsets

/ Lightweight Alloy Frame and Fork





# CARPE

SIZES	XS	S	M	L	XL
1 - Seat Tube (C-T)	430	480	525	555	580
2 - Top Tube (EFF)	521	546	559	580	601
3 - Head Tube	109	127	150	170	200
4 - Chainstay	435	435	435	435	435
5 - BB Height	281	281	283	283	285
6 - BB Drop	70	70	68	68	66
7 - Wheelbase	1021	1037	1052	1063	1075
8 - Head Angle	71	71	71	71,5	72
9 - Seat Angle	75	74	74	73,5	73
10 - Standover	738	768	800	824	852
11 - Reach	378	388	395	405	410
12 - Stack	535	552	571	592	625
13 - Fork Length	400	400	400	400	400

HEIGHT (cm)	HEIGHT (in)	SIZE
150-160	59.1"-63.0"	XS-700
160-170	63.0"-66.9"	S-700
170-180	66.9"-70.9"	M-700
180-190	70.9"-74.8"	L-700
190-200	74.8"-78.7"	XL-700

-  Black (Matt) QK
-  White-Bright-Red (Gloss) QP
-  Blue Indigo-Turquesa (Matt-Gloss) QS
-  Bright Red-Black (Matt) QT

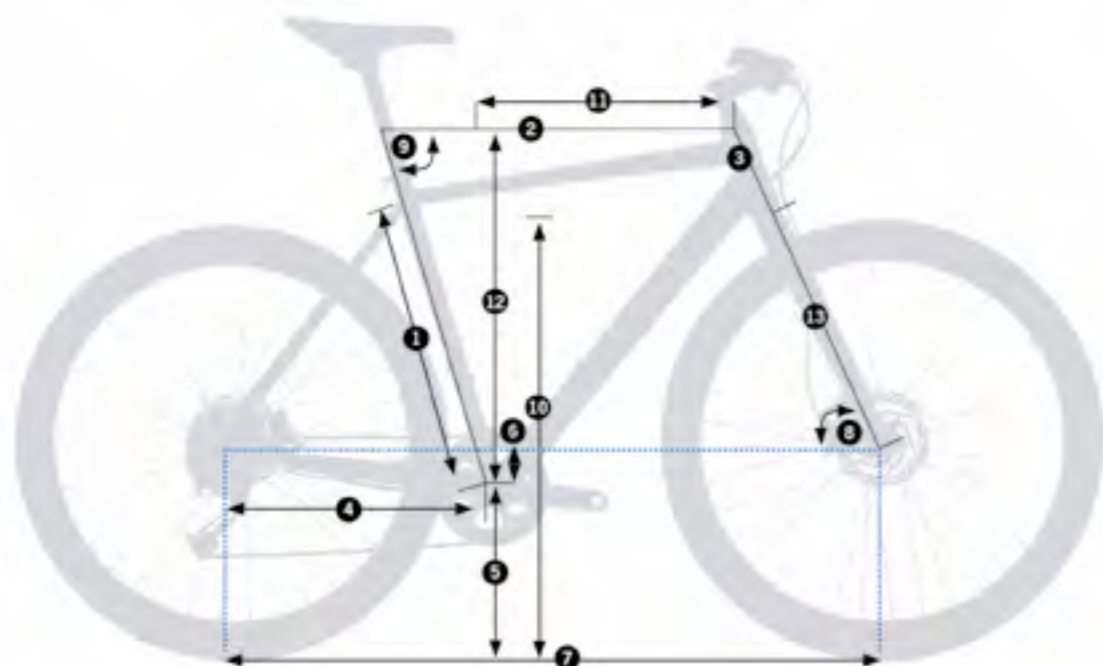

# CARPE 10

MyO<sub>2.0</sub>

Code	J423		
Size	Crank	Stem	Handlebar
XS	170	75	680
S	170	75	680
M	170	75	680
L	170	75	680
XL	170	75	680



<b>Frame</b>	Orbea Urban Speed, Aluminium 6000, Orbea Tube Shaping, Flat Mount Disc Brake, 135x9 QR, Carrier and Mudguard compatible, max 700x40C, Inner Cable routing.
<b>Fork</b>	Speed 400mm Carbon Flat mount
<b>Crankset</b>	Prowheel 42 Steel Custom logo
<b>Headset</b>	1-1/8" Semi-Integrated
<b>Handlebar</b>	Orbea AL320 Riser 680mm
<b>Stem</b>	Orbea TDS-C301
<b>Shifters</b>	Shimano XT M780
<b>Brakes</b>	Shimano MT201 Hydraulic Disc
<b>Rear Derailleur</b>	Shimano XT M781 Shadow
<b>Chain</b>	Fsa Team Issue
<b>Wheels</b>	Orbea Airline Corsa Disc 700X19c



<b>Cassette</b>	Shimano HG50 11-36t 10-Speed
<b>Tyres</b>	Kenda K1067 700x38C Reflective type+puncture protection
<b>Pedals</b>	VPE-538 Black
<b>Seatpost</b>	Orbea C255 27.2x300mm
<b>Saddle</b>	Velo VL-1221 Brooks Cambium C17 165mm Wide
<b>Mudguard</b>	Orbea SKS EDGE Alu C56R
<b>Front light</b>	Joss Spanninga Kendo XDAS Dinamo
<b>Rear light</b>	Joss Spanninga Lineo XDS Dinamo
<b>Dynamo</b>	Shimano DH-3D37-NT, 6V Dynamo 3.0W
<b>Quick stand</b>	Ursus Mooi 40mm rear adjustable

# CARPE 20

MyO<sub>2.0</sub>

Code	J422		
Size	Crank	Stem	Handlebar
XS	170	70	640
S	170	70	640
M	170	70	640
L	170	70	640
XL	170	70	640



<b>Frame</b>	Orbea Urban Speed, Aluminium 6000, Orbea Tube Shaping, Flat Mount Disc Brake, 135x9 QR, Carrier and Mudguard compatible, max 700x40C, Inner Cable routing.
<b>Fork</b>	Speed 400mm Carbon Flat mount
<b>Crankset</b>	Prowheel 42 Steel Custom logo
<b>Headset</b>	1-1/8" Semi-Integrated
<b>Handlebar</b>	Orbea OC-I Riser 640mm
<b>Stem</b>	Orbea OC-II
<b>Shifters</b>	Shimano Altus M2000
<b>Brakes</b>	Shimano MT201 Hydraulic Disc
<b>Rear Derailleur</b>	Shimano Altus M2000 SGS Shadow
<b>Chain</b>	Shimano HG53 9-Speed
<b>Wheels</b>	Orbea Airline Corsa Disc 700X19c



<b>Cassette</b>	Shimano HG200 11-36 9-Speed
<b>Hub</b>	Safety Lock
<b>Tyres</b>	Kenda K1067 700x38C Reflective type+puncture protection
<b>Pedals</b>	VPE-538 Black
<b>Seatpost</b>	Orbea OC-I 27.2x400mm
<b>Saddle</b>	Velo VL-1221 Brooks Cambium C17 165mm Wide
<b>Rear carrier</b>	
<b>Mudguard</b>	SKS Edge Alu + Side Bag Carrier SKS Edge Alu + Side Bag Carrier + Lights (F-Lineo/R-Kendo)
<b>Front light</b>	
<b>Rear light</b>	

<b>Quick stand</b>	Ursus Mooi 40mm rear adjustable
--------------------	---------------------------------

## CARPE 30

Code	J421		
<b>Size</b>	<b>Crank</b>	<b>Stem</b>	<b>Handlebar</b>
XS	170	70	640
S	170	70	640
M	170	70	640
L	170	70	640
XL	170	70	640



<b>Frame</b>	Orbea Urban Speed, Aluminium 6000, Orbea Tube Shaping, Flat Mount Disc Brake, 135x9 QR, Carrier and Mudguard compatible, max 700x40C, Inner Cable routing.
<b>Fork</b>	Speed 400mm Alloy Flat mount Speed 400mm Carbon Flat Mount
<b>Crankset</b>	Prowheel 42 Steel Custom logo
<b>Headset</b>	1-1/8" Semi-Integrated
<b>Handlebar</b>	Orbea OC-I Riser 640mm
<b>Stem</b>	Orbea OC-II
<b>Shifters</b>	Shimano M310
<b>Brakes</b>	Shimano MT200 Hydraulic Disc
<b>Rear Derailleur</b>	Shimano Altus M310
<b>Chain</b>	KMC X8

<b>Wheels</b>	Orbea Airline Corsa Disc 700X19c
<b>Cassette</b>	Shimano HG200 12-32t 8-Speed
<b>Tyres</b>	Kenda K1067 700x38C Reflective type+puncture protection
<b>Pedals</b>	VPE-538 Black
<b>Seatpost</b>	Orbea OC 27.2x400mm
<b>Saddle</b>	Velo VL-1221 Brooks Cambium C17 165mm Wide
<b>Rear carrier</b>	
<b>Mudguard</b>	SKS Edge Alu + Side Bag Carrier SKS Edge Alu + Side Bag Carrier + Lights (F-Lineo/R-Kendo)
<b>Front light</b>	
<b>Rear light</b>	

<b>Quick stand</b>	Ursus Mooi 40mm rear adjustable
--------------------	---------------------------------

## CARPE 40

Code	J420		
<b>Size</b>	<b>Crank</b>	<b>Stem</b>	<b>Handlebar</b>
XS	170	70	640
S	170	70	640
M	170	70	640
L	170	70	640
XL	170	70	640



<b>Frame</b>	Orbea Urban Speed, Aluminium 6000, Orbea Tube Shaping, Flat Mount Disc Brake, 135x9 QR, Carrier and Mudguard compatible, max 700x40C, Inner Cable routing.
<b>Fork</b>	Speed 400mm Steel Post mount Speed 400mm Alloy Flat Mount
<b>Crankset</b>	Prowheel 42 Steel Custom logo
<b>Headset</b>	1-1/8" Semi-Integrated
<b>Handlebar</b>	Orbea OC-I Riser 640mm
<b>Stem</b>	Orbea OC
<b>Shifters</b>	Shimano M310
<b>Brake levers</b>	Orbea Trekking Alu 4-finger
<b>Brakes</b>	Shimano TX805 Mechanical Disc
<b>Rear Derailleur</b>	Shimano TY300

<b>Chain</b>	Z7 GYBR
<b>Wheels</b>	Orbea Airline Corsa Disc 700X19c
<b>Cassette</b>	Shimano HG200 12-32t 7-Speed
<b>Tyres</b>	Kenda K1067 700x38C Reflective type+puncture protection
<b>Pedals</b>	VPE-538 Black
<b>Seatpost</b>	Orbea OC 27.2x400mm
<b>Saddle</b>	Velo VL-1221 Brooks Cambium C17 165mm Wide
<b>Rear carrier</b>	
<b>Mudguard</b>	SKS Edge Alu + Side Bag Carrier SKS Edge Alu + Side Bag Carrier + Lights (F-Lineo/R-Kendo)
<b>Front light</b>	

<b>Rear light</b>	
<b>Quick stand</b>	Ursus Mooi 40mm rear adjustable



## ONE BIKE MANY LIVES

Vector is at home in the city or on open roads winding through the hills. A blend of low weight and durability usually reserved for more expensive machines, Vector is the perfect tool for doing whatever you like - whether it's commuting from work or taking a few extra minutes for a detour in the park. Vector is Orbea's new multi-role bike that emphasizes versatility. A companion for every part of your life.

**VECTOR**



**VECTOR IS LIGHTWEIGHT**

- / Shimano Road Groupsets
- / Lightweight Alloy Frame and Fork
- / 28mm Tires\*
- / High Quality Wheels

**VECTOR IS DURABLE**

- / Orbea Lifetime Warranty
- / Shimano Hubs & Bearings
- / Internal Cable Routing



**VECTOR IS ADAPTABLE**

- / Balanced Sport Geometry
- / Adjustable Stem and Flat Bar\*
- / Mudguard & Rack Compatible

**VECTOR IS SAFE**

- / Highly Reflective
- / Disc Only
- / Puncture Resistant Tires\*
- / Wheel Security



# VECTOR

SIZES	XS	S	M	L	XL
1 - Seat Tube (C-T)	430	480	525	555	580
2 - Top Tube (EFF)	521	546	559	580	601
3 - Head Tube	109	127	150	170	200
4 - Chainstay	435	435	435	435	435
5 - BB Height	281	281	283	283	285
6 - BB Drop	70	70	68	68	66
7 - Wheelbase	1021	1037	1052	1063	1075
8 - Head Angle	71	71	71	71,5	72
9 - Seat Angle	75	74	74	73,5	73
10 - Standover	738	768	800	824	852
11 - Reach	378	388	395	405	410
12 - Stack	535	552	571	592	625
13 - Fork Length	400	400	400	400	400

HEIGHT (cm)	HEIGHT (in)	SIZE
150-160	59.1"-63.0"	XS-700
160-170	63.0"-66.9"	S-700
170-180	66.9"-70.9"	M-700
180-190	70.9"-74.8"	L-700
190-200	74.8"-78.7"	XL-700

-  Black (Matt-Gloss) **QC**
-  Green (Matt-Gloss) **QE**
-  Blue (Matt-Gloss) **QG**
-  Bright Red-Black (Matt-Gloss) **QI**

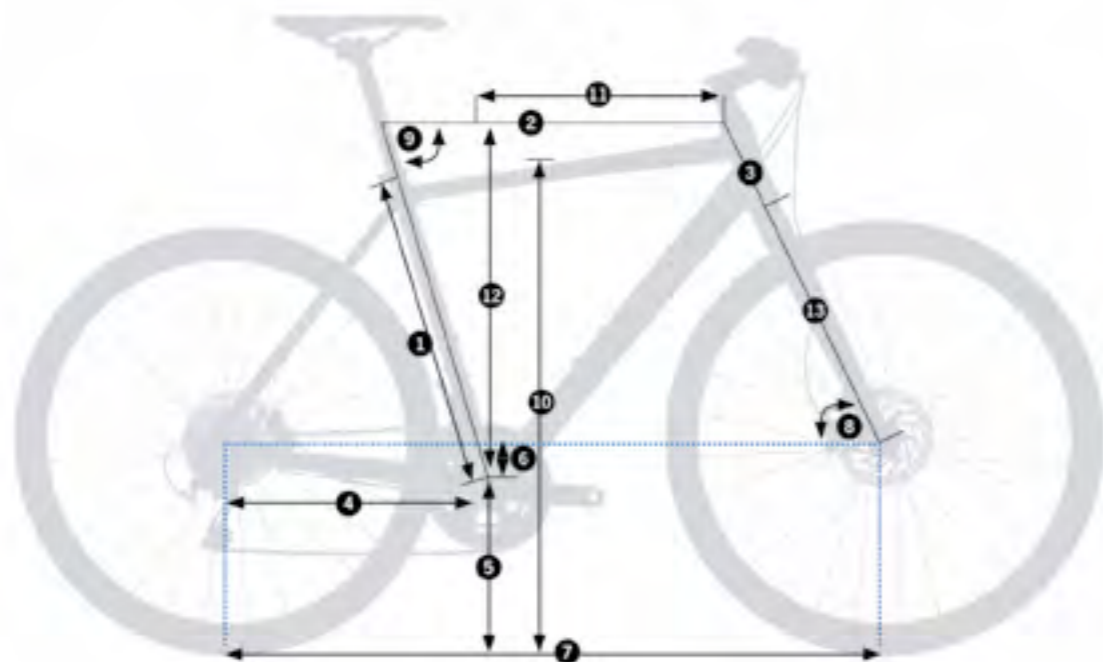

# VECTOR DROP LTD *MyO.com*

Code	J430		
Size	Crank	Stem	Handlebar
XS	170	75	420
S	170	75	420
M	170	75	420
L	172	75	420
XL	175	75	420



<b>Frame</b>	Orbea Urban Speed, Aluminium 6000, Orbea Tube Shaping, Flat Mount Disc Brake, 135x9 QR, Carrier and Mudguard compatible, max 700x40C, Inner Cable routing.
<b>Fork</b>	Speed 400mm Carbon Flat mount
<b>Crankset</b>	Shimano Tiagra 4700 34x50t
<b>Headset</b>	1-1/8" Semi-Integrated
<b>Handlebar</b>	Orbea OC-II Silver
<b>Handlebar Plugs</b>	Brooks Cambium
<b>Stem</b>	Orbea TDS-C301
<b>Shifters</b>	Shimano ST-RS405
<b>Brakes</b>	Shimano RS405 Hydraulic Disc
<b>Rear Derailleur</b>	Shimano Tiagra 4700 GS



<b>Front Derailleur</b>	Shimano Tiagra 4700
<b>Chain</b>	KMC X10
<b>Wheels</b>	Orbea Airline Corsa Disc 700x19c
<b>Cassette</b>	Shimano Tiagra HG-500 11-32t 10-Speed
<b>Hub</b>	Safety Lock
<b>Tyres</b>	Kenda K1098 700x32 Bronw Side Walls Reflective Tape
<b>Pedals</b>	N/A
<b>Seatpost</b>	Orbea C255 27.2x300mm
<b>Saddle</b>	Brooks Cambium C17 165mm wide
<b>Mudguard</b>	Orbea SKS EDGE Alu C56R
<b>Quick stand</b>	Ursus Mooi 40mm rear adjustable

# VECTOR DROP *MyO.com*

Code	J429		
Size	Crank	Stem	Handlebar
XS	170	100	420
S	170	100	420
M	170	100	420
L	172	100	420
XL	175	100	420



<b>Frame</b>	Orbea Urban Speed, Aluminium 6000, Orbea Tube Shaping, Flat Mount Disc Brake, 135x9 QR, Carrier and Mudguard compatible, max 700x40C, Inner Cable routing.
<b>Fork</b>	Speed 400mm Carbon Flat mount
<b>Crankset</b>	Shimano Tiagra 4700 34x50t
<b>Headset</b>	1-1/8" Semi-Integrated Aluminium Cup
<b>Handlebar</b>	Orbea OC-II
<b>Handlebar Plugs</b>	Bar Tape Brooks Cambium Black
<b>Stem</b>	Orbea OC-II
<b>Shifters</b>	Shimano ST-RS405
<b>Brakes</b>	Shimano RS405 Hydraulic Disc



<b>Rear Derailleur</b>	Shimano Tiagra 4700 GS
<b>Front Derailleur</b>	Shimano Tiagra 4700
<b>Chain</b>	KMC X10
<b>Wheels</b>	Orbea Airline Corsa Disc 700x19c
<b>Cassette</b>	Shimano Tiagra HG-500 11-32t 10-Speed
<b>Hub</b>	Safety Lock
<b>Tyres</b>	Kenda K1098 700x32 Reflective Tape Kenda K1098 700x28C Reflective type+puncture protection
<b>Pedals</b>	N/A
<b>Seatpost</b>	Orbea OC-I 27.2x400mm
<b>Saddle</b>	Selle Royal Seta RS
<b>Rear carrier</b>	SKS Edge Alu + Side Bag Carrier
<b>Mudguard</b>	

<b>Quick stand</b>	Ursus Mooi 40mm rear adjustable
--------------------	---------------------------------

## VECTOR 10

MyO<sub>2.0</sub>

Code	J426		
Size	Crank	Stem	Handlebar
XS	170	90	640
S	170	90	640
M	170	90	640
L	172	90	640
XL	175	90	640



<b>Frame</b>	Orbea Urban Speed, Aluminium 6000, Orbea Tube Shaping, Flat Mount Disc Brake, 135x9 QR, Carrier and Mudguard compatible, max 700x40C, Inner Cable routing,
<b>Fork</b>	Speed 400mm Carbon Flat mount
<b>Crankset</b>	Shimano Tiagra 4700 34x50t Shimano Tiagra 30x39x50t
<b>Headset</b>	1-1/8" Semi-Integrated Aluminium Cup
<b>Handlebar</b>	Orbea OC-I Riser 640mm
<b>Stem</b>	Orbea OC-II
<b>Shifters</b>	Shimano Tiagra 4700
<b>Brakes</b>	Shimano MT201 Hydraulic Disc
<b>Rear Derailleur</b>	Shimano Tiagra 4700 GS
<b>Front Derailleur</b>	Shimano Tiagra 4700

<b>Chain</b>	KMC X10
<b>Wheels</b>	Shimano RX-010 Disc CL Clincher
<b>Cassette</b>	Shimano Tiagra HG-500 11-34t 10-Speed
<b>Hub</b>	Safety Lock
<b>Tyres</b>	Kenda K1098 700x32 Reflective Tape Kenda K1098 700x28C Reflective type+puncture protection
<b>Pedals</b>	N/A
<b>Seatpost</b>	Orbea OC-I 27.2x400mm
<b>Saddle</b>	Selle Royal Seta RS
<b>Rear carrier</b>	
<b>Mudguard</b>	SKS Edge Alu + Side Bag Carrier
<b>Quick stand</b>	

Ursus Mooi 40mm rear adjustable

## VECTOR 20

MyO<sub>2.0</sub>

Code	J425		
Size	Crank	Stem	Handlebar
XS	170	90	640
S	170	90	640
M	170	90	640
L	170	90	640
XL	170	90	640



<b>Frame</b>	Orbea Urban Speed, Aluminium 6000, Orbea Tube Shaping, Flat Mount Disc Brake, 135x9 QR, Carrier and Mudguard compatible, max 700x40C, Inner Cable routing,
<b>Fork</b>	Speed 400mm Carbon Flat mount
<b>Crankset</b>	Prowheel 32x48 Steel Custom logo Shimano Sora 30x39x50
<b>Headset</b>	1-1/8" Semi-Integrated Aluminium Cup
<b>Handlebar</b>	Orbea OC-I Riser 640mm
<b>Stem</b>	Orbea OC-II
<b>Shifters</b>	Shimano Sora
<b>Brakes</b>	Shimano MT200 Hydraulic Disc
<b>Rear Derailleur</b>	Shimano Sora 3000GS
<b>Front Derailleur</b>	Shimano Sora 3000

<b>Chain</b>	Shimano HG53 9-Speed
<b>Wheels</b>	Orbea Airline Corsa Disc 700X19c
<b>Cassette</b>	Shimano HG400 11-34t 9-Speed
<b>Tyres</b>	Kenda K1098 700x32 Reflective Tape Kenda K1098 700x28C Reflective type+puncture protection
<b>Pedals</b>	N/A
<b>Seatpost</b>	Orbea OC-I 27.2x400mm
<b>Saddle</b>	Selle Royal Seta RS
<b>Rear carrier</b>	
<b>Mudguard</b>	SKS Edge Alu + Side Bag Carrier
<b>Quick stand</b>	Ursus Mooi 40mm rear adjustable

## VECTOR 30

MyO<sub>2.0</sub>

Code	J424		
Size	Crank	Stem	Handlebar
XS	170	90	640
S	170	90	640
M	170	90	640
L	170	90	640
XL	170	90	640



<b>Frame</b>	Orbea Urban Speed, Aluminium 6000, Orbea Tube Shaping, Flat Mount Disc Brake, 135x9 QR, Carrier and Mudguard compatible, max 700x40C, Inner Cable routing,
<b>Fork</b>	Speed 400mm Alloy Flat mount Speed 400mm Carbon Flat Mount
<b>Crankset</b>	Prowheel 32x48 Steel Custom logo Shimano Claris 30x39x50
<b>Headset</b>	1-1/8" Semi-Integrated Aluminium Cup
<b>Handlebar</b>	Orbea OC-I Riser 640mm
<b>Stem</b>	Orbea OC-II
<b>Shifters</b>	Shimano Claris SL-R2000-R
<b>Brake levers</b>	Shimano Claris BL-R2000
<b>Brakes</b>	Shimano TX805 Mechanical Disc

<b>Rear Derailleur</b>	Shimano Claris RD-R2000-GS
<b>Front Derailleur</b>	Shimano Claris FD-R2000-F
<b>Chain</b>	KMC X8
<b>Wheels</b>	Orbea Airline Corsa Disc 700X19c
<b>Cassette</b>	Shimano HG50 11-34t 8-Speed
<b>Tyres</b>	Kenda K1098 700x32 Reflective Tape Kenda K1098 700x28C Reflective type+puncture protection
<b>Pedals</b>	N/A
<b>Seatpost</b>	Orbea OC 27.2x400mm
<b>Saddle</b>	Selle Royal Seta RS
<b>Rear carrier</b>	
<b>Mudguard</b>	SKS Edge Alu + Side Bag Carrier

Quick stand

Ursus Mooi 40mm rear adjustable



# LEISURE

COMFORT



## **ALL-USE** WITH COMFORT AND CAPABILITY

If what you're looking for is a bike with a comfortable position for excursions and getting around the city, you'll love Orbea's Comfort model. Think about what you're going to do, and you'll know which frame you need!

**COMFORT**





### COMFORT IS SAFE

- / Reflective Tires
- / Front and Rear Lights\*
- / Frame Lock\*
- / Large Platform, Reflective Pedals with Excellent Grip

### COMFORT IS DURABLE

- / Internal Cable Routing
- / Orbea Lifetime Warranty

### COMFORT IS CAPABLE

- / Rack Compatible
- / Frame Lock Compatible
- / Kickstand Compatible
- / Child Seat Compatible



## COMFORT TOP BAR

SIZES	S	M	L	XL
1 - Seat Tube (C-T)	402	430	465	500
2 - Top Tube (EFF)	535	576	597	616
3 - Head Tube	125	120	130	145
4 - Chainstay	450	450	450	450
5 - BB Height	285	303	303	303
6 - BB Drop	65	65	65	65
7 - Wheelbase	1055	1077	1099	1119
8 - Head Angle	69.5°	70.5°	70.5°	70.5°
9 - Seat Angle	74°	74°	74°	74°
10 - Standover	764	813	833	885
11 - Reach	360	400	418	433
12 - Stack	612	614	623	637
13 - Fork Length	475	475	475	475

HEIGHT (cm)	HEIGHT (in)	SIZE
150-165	59.1"-65.0"	S
165-175	65.0"-68.9"	M
175-185	68.9"-72.8"	L
185-208	72.8"-81.9"	XL

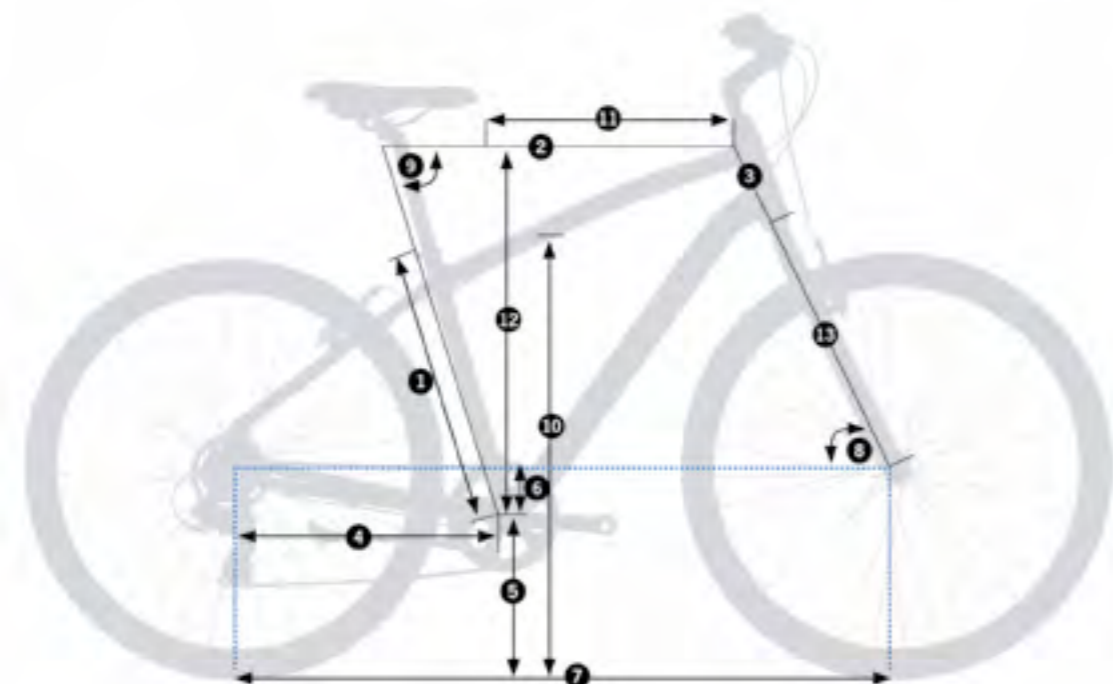

## COMFORT 10

Code	J406		
Size	Crank	Stem	Handlebar
S	170	90	660
M	170	90	660
L	170	90	660
XL	170	90	660



<b>Frame</b>	Comfort Top Bar
<b>Fork</b>	SR Suntour NEX E-25 63mm Disc
<b>Crankset</b>	Shimano M371 26x36x48t w/CG
<b>Headset</b>	1-1/8" Semi-Integrated
<b>Handlebar</b>	Orbea Comfort Riser Alu 660mm
<b>Stem</b>	Orbea Black Adjustable
<b>Shifters</b>	Shimano Deore M590
<b>Brakes</b>	Shimano MT200 Hydraulic Disc
<b>Rear Derailleur</b>	Shimano Deore M592 Shadow
<b>Front Derailleur</b>	Shimano Altus M370 31,8mm
<b>Chain</b>	Shimano HG53 9-Speed
<b>Wheels</b>	Mach1 ER20 19c
<b>Cassette</b>	Shimano HG200 11-36 9-Speed
<b>Tyres</b>	Kenda K935 1,65" Reflex



<b>Pedals</b>	VP-469 Black
<b>Seatpost</b>	Orbea 27.2x350mm w/Suspension
<b>Saddle</b>	Selle Royal Milo Plus HR
<b>Quick stand</b>	Ursus Mooi adjust

## COMFORT 20

Code	J404		
Size	Crank	Stem	Handlebar
S	170	150	640
M	170	150	640
L	170	150	640
XL	170	150	640



<b>Frame</b>	Comfort Top Bar
<b>Fork</b>	SR Suntour XCE 80mm V-Brake QR
<b>Crankset</b>	Shimano M371 26x36x48t w/CG
<b>Headset</b>	1-1/8" Semi-Integrated
<b>Handlebar</b>	Orbea City Riser Alu 640mm
<b>Stem</b>	Orbea Adjustable Alu
<b>Shifters</b>	Shimano STEF 65 4-finger
<b>Brakes</b>	Shimano T4000 V-Brake
<b>Rear Derailleur</b>	Shimano Altus M2000 SGS Shadow
<b>Front Derailleur</b>	Shimano Altus M370 31,8mm
<b>Chain</b>	Shimano HG53 9-Speed
<b>Wheels</b>	Orbea Scorpion DW
<b>Cassette</b>	Shimano HG200 11-36 9-Speed
<b>Tyres</b>	Kenda K935 1,65" Reflex



<b>Pedals</b>	VP-469 Black
<b>Seatpost</b>	Orbea OC-1 27.2x400mm
<b>Saddle</b>	Selle Royal Milo Plus HR
<b>Quick stand</b>	Ursus Mooi adjust

## COMFORT 30

Code	J402		
Size	Crank	Stem	Handlebar
S	170	150	640
M	170	150	640
L	170	150	640
XL	170	150	640



<b>Frame</b>	Comfort Top Bar
<b>Fork</b>	SR Suntour XCE 80mm V-Brake QR
<b>Crankset</b>	Shimano TY301 28x38x48t
<b>Headset</b>	1-1/8" Semi-Integrated
<b>Handlebar</b>	Orbea City Riser Alu 640mm
<b>Stem</b>	Orbea Adjustable Alu
<b>Brakes</b>	Orbea V-Brake
<b>Rear Derailleur</b>	Shimano TY300
<b>Front Derailleur</b>	Shimano TY510 31.8mm
<b>Chain</b>	Z7 GYBR
<b>Wheels</b>	Orbea Scorpion DW
<b>Cassette</b>	Shimano HG200 12-32t 7-Speed
<b>Tyres</b>	Kenda K935 700x42 Reflective Logo
<b>Pedals</b>	VPE-537 Black

<b>Seatpost</b>	Orbea OC 27.2x400mm
<b>Saddle</b>	Selle Royal Milo Plus HR
<b>Quick stand</b>	Ursus Mooi adjust

## COMFORT 40

Code	J400		
Size	Crank	Stem	Handlebar
S	170	150	640
M	170	150	640
L	170	150	640
XL	170	150	640



<b>Frame</b>	Comfort Top Bar
<b>Fork</b>	Orbea Hi-Ten V-Brake+Disc
<b>Crankset</b>	Pioneer Prowheel 42t
<b>Headset</b>	1-1/8" Semi-Integrated
<b>Handlebar</b>	Orbea City Riser Alu 640mm
<b>Stem</b>	Orbea Alu
<b>Shifters</b>	Shimano M310
<b>Brake levers</b>	Orbea Trekking Alu 4-finger
<b>Brakes</b>	Orbea V-Brake
<b>Rear Derailleur</b>	Shimano TY300
<b>Chain</b>	Z7 GYBR
<b>Wheels</b>	Orbea Scorpion DW
<b>Cassette</b>	Shimano TZ31 14-34t 7-Speed
<b>Tyres</b>	Kenda K935 700x42 Reflective Logo

<b>Pedals</b>	VPE-537 Black
<b>Seatpost</b>	Orbea OC 27.2x400mm
<b>Saddle</b>	Selle Royal One 6007 HR
<b>Quick stand</b>	Central alloy

## COMFORT 10 PACK

Code	J414		
Size	Crank	Stem	Handlebar
S	170	90	660
M	170	90	660
L	170	90	660
XL	170	90	660



<b>Frame</b>	Comfort Top Bar
<b>Fork</b>	SR Suntour NEX E-25 63mm Disc
<b>Crankset</b>	Shimano M371 26x36x48t w/CG
<b>Headset</b>	1-1/8" Semi-Integrated
<b>Handlebar</b>	Orbea Comfort Riser Alu 660mm
<b>Stem</b>	Orbea Black Adjustable
<b>Shifters</b>	Shimano Deore M590
<b>Brakes</b>	Shimano MT200 Hydraulic Disc
<b>Rear Derailleur</b>	Shimano Deore M592 Shadow
<b>Front Derailleur</b>	Shimano Altus M370 31.8mm
<b>Chain</b>	Shimano HG53 9-Speed
<b>Wheels</b>	Mach1 ER20 19c
<b>Cassette</b>	Shimano HG200 11-36 9-Speed
<b>Tyres</b>	Kenda K935 1,65" Reflex

<b>Pedals</b>	VP-469 Black
<b>Seatpost</b>	Orbea 27.2x350mm w/Suspension
<b>Saddle</b>	Selle Royal Milo Plus HR
<b>Rear carrier</b>	PORTABULTOS DE ACERO PARA RUEDAS DE 26 Y 28 NEGRO
<b>Mudguard</b>	SKS 28"
<b>Front light</b>	Joss Spanninga Kendo XDAS Dinamo
<b>Rear light</b>	Joss Spanninga Lineo XDS Dinamo
<b>Dynamo</b>	Shimano DH-3D37-NT, 6V Dynamo 3.0W
<b>Lock</b>	Abus Pro Shield Plus frame lock
<b>Quick stand</b>	Ursus Mooi adjust

## COMFORT 20 PACK

Code	J412		
Size	Crank	Stem	Handlebar
S	170	150	640
M	170	150	640
L	170	150	640
XL	170	150	640



<b>Frame</b>	Comfort Top Bar
<b>Fork</b>	SR Suntour XCE 80mm V-Brake QR
<b>Crankset</b>	Shimano M371 26x36x48t w/CG
<b>Headset</b>	1-1/8" Semi-Integrated
<b>Handlebar</b>	Orbea City Riser Alu 640mm
<b>Stem</b>	Orbea Adjustable Alu
<b>Shifters</b>	Shimano STEF 65 4-finger
<b>Brakes</b>	Shimano T4000 V-Brake
<b>Rear Derailleur</b>	Shimano Altus M2000 SGS Shadow
<b>Front Derailleur</b>	Shimano Altus M370 31.8mm
<b>Chain</b>	Shimano HG53 9-Speed
<b>Wheels</b>	Orbea Scorpion DW
<b>Cassette</b>	Shimano HG200 11-36 9-Speed
<b>Tyres</b>	Kenda K935 1,65" Reflex

<b>Pedals</b>	VP-469 Black
<b>Seatpost</b>	Orbea OC-1 27.2x400mm
<b>Saddle</b>	Selle Royal Milo Plus HR
<b>Rear carrier</b>	PORTABULTOS DE ACERO PARA RUEDAS DE 26 Y 28 NEGRO
<b>Mudguard</b>	SKS 28"
<b>Front light</b>	Joss Spanninga Kendo XDAS Dinamo
<b>Rear light</b>	Joss Spanninga Lineo XDS Dinamo
<b>Dynamo</b>	Shimano C3000 Dynamo
<b>Quick stand</b>	Ursus Mooi adjust

## COMFORT 30 PACK

Code	J410		
Size	Crank	Stem	Handlebar
S	170	150	640
M	170	150	640
L	170	150	640
XL	170	150	640



<b>Frame</b>	Comfort Top Bar
<b>Fork</b>	SR Suntour XCE 80mm V-Brake QR
<b>Crankset</b>	Shimano TY301 28x38x48t
<b>Headset</b>	1-1/8" Semi-Integrated
<b>Handlebar</b>	Orbea City Riser Alu 640mm
<b>Stem</b>	Orbea Adjustable Alu
<b>Brakes</b>	Orbea V-Brake
<b>Rear Derailleur</b>	Shimano TY300
<b>Front Derailleur</b>	Shimano TY510 31.8mm
<b>Chain</b>	Z7 GYBR
<b>Wheels</b>	Orbea Scorpion DW
<b>Cassette</b>	Shimano HG200 12-32t 7-Speed
<b>Tyres</b>	Kenda K935 700x42 Reflective Logo
<b>Pedals</b>	VPE-537 Black

<b>Seatpost</b>	Orbea OC 27.2x400mm
<b>Saddle</b>	Selle Royal Milo Plus HR
<b>Rear carrier</b>	PORTABULTOS DE ACERO PARA RUEDAS DE 26 Y 28 NEGRO
<b>Mudguard</b>	Orbea SKS 28" Black
<b>Front light</b>	Joss Spanninga Kendo XDAS Dinamo
<b>Rear light</b>	Basta Riff
<b>Dynamo</b>	Shimano C3000 Dynamo
<b>Quick stand</b>	Ursus Mooi adjust

## COMFORT 40 PACK

Code	J408		
Size	Crank	Stem	Handlebar
S	170	150	640
M	170	150	640
L	170	150	640
XL	170	150	640



<b>Frame</b>	Comfort Top Bar
<b>Fork</b>	Orbea Hi-Ten V-Brake+Disc
<b>Crankset</b>	Pioneer Prowheel 42t
<b>Headset</b>	1-1/8" Semi-Integrated
<b>Handlebar</b>	Orbea City Riser Alu 640mm
<b>Stem</b>	Orbea Alu
<b>Shifters</b>	Shimano M310
<b>Brake levers</b>	Orbea Trekking Alu 4-finger
<b>Brakes</b>	Orbea V-Brake
<b>Rear Derailleur</b>	Shimano TY300
<b>Chain</b>	Z7 GYBR
<b>Wheels</b>	Orbea Scorpion DW
<b>Cassette</b>	Shimano TZ31 14-34t 7-Speed
<b>Tyres</b>	Kenda K935 700x42 Reflective Logo

<b>Pedals</b>	VPE-537 Black
<b>Seatpost</b>	Orbea OC 27.2x400mm
<b>Saddle</b>	Selle Royal One 6007 HR
<b>Rear carrier</b>	PORTABULTOS DE ACERO PARA RUEDAS DE 26 Y 28 NEGRO
<b>Mudguard</b>	Orbea SKS 28" Black
<b>Front light</b>	Joss Spanninga Galeo XB Battery
<b>Rear light</b>	Basta Riff
<b>Quick stand</b>	Central alloy

## COMFORT MID BAR

SIZES	S	M	L	XL
1 - Seat Tube (C-T)	402	430	465	500
2 - Top Tube (EFF)	535	569	585	605
3 - Head Tube	125	130	140	150
4 - Chainstay	450	450	450	450
5 - BB Height	285	303	303	303
6 - BB Drop	65	65	65	65
7 - Wheelbase	1055	1071	1087	1109
8 - Head Angle	70.5°	70.5°	70.5°	70.5°
9 - Seat Angle	74°	74°	74°	74°
10 - Standover	679	695	703	724
11 - Reach	360	390	403	418
12 - Stack	612	624	633	652
13 - Fork Length	475	475	475	475

HEIGHT (cm)	HEIGHT (in)	SIZE
150-165	59.1"-65.0"	S
165-175	65.0"-68.9"	M
175-185	68.9"-72.8"	L
185-208	72.8"-81.9"	XL

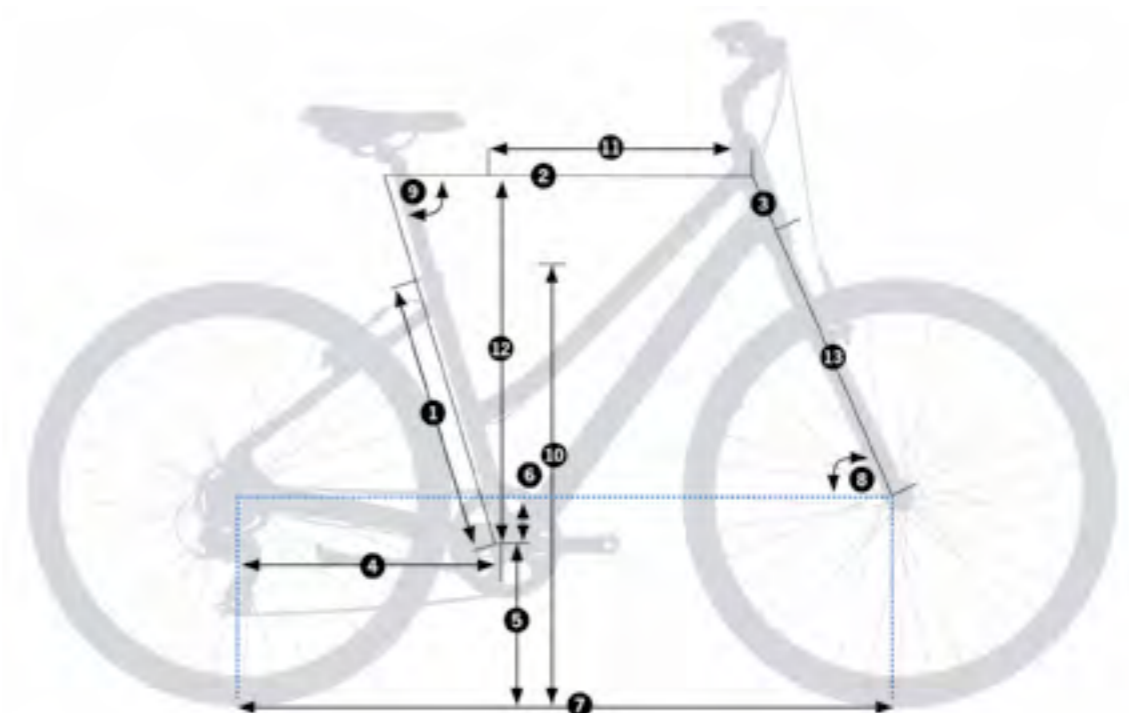
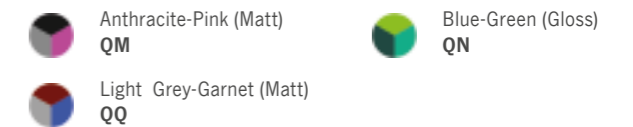

## COMFORT 12

Code	J407		
Size	Crank	Stem	Handlebar
S	170	90	660
M	170	90	660
L	170	90	660
XL	170	90	660



<b>Frame</b>	Comfort Mid Bar
<b>Fork</b>	SR Suntour NEX E-25 63mm Disc
<b>Crankset</b>	Shimano M371 26x36x48t w/CG
<b>Headset</b>	1-1/8" Semi-Integrated
<b>Handlebar</b>	Orbea Comfort Riser Alu 660mm
<b>Stem</b>	Orbea Black Adjustable
<b>Shifters</b>	Shimano Deore M590
<b>Brakes</b>	Shimano MT200 Hydraulic Disc
<b>Rear Derailleur</b>	Shimano Deore M592 Shadow
<b>Front Derailleur</b>	Shimano Altus M370 31,8mm
<b>Chain</b>	Shimano HG53 9-Speed
<b>Wheels</b>	Mach1 ER20 19c
<b>Cassette</b>	Shimano HG200 11-36 9-Speed
<b>Tyres</b>	Kenda K935 1,65" Reflex

<b>Pedals</b>	VP-469 Black
<b>Seatpost</b>	Orbea 27.2x350mm w/Suspension
<b>Saddle</b>	Selle Royal Milo Plus DR
<b>Quick stand</b>	Ursus Mooi adjust

## COMFORT 22

Code	J405		
Size	Crank	Stem	Handlebar
S	170	150	640
M	170	150	640
L	170	150	640
XL	170	150	640



<b>Frame</b>	Comfort Mid Bar
<b>Fork</b>	SR Suntour XCE 80mm V-Brake QR
<b>Crankset</b>	Shimano M371 26x36x48t w/CG
<b>Headset</b>	1-1/8" Semi-Integrated
<b>Handlebar</b>	Orbea City Riser Alu 640mm
<b>Stem</b>	Orbea Adjustable Alu
<b>Shifters</b>	Shimano STEF 65 4-finger
<b>Brakes</b>	Shimano T4000 V-Brake
<b>Rear Derailleur</b>	Shimano Altus M2000 SGS Shadow
<b>Front Derailleur</b>	Shimano Altus M370 31,8mm
<b>Chain</b>	Shimano HG53 9-Speed
<b>Wheels</b>	Orbea Scorpion DW
<b>Cassette</b>	Shimano HG200 11-36 9-Speed
<b>Tyres</b>	Kenda K935 1,65" Reflex

<b>Pedals</b>	VP-469 Black
<b>Seatpost</b>	Orbea OC-1 27.2x400mm
<b>Saddle</b>	Selle Royal Milo Plus DR
<b>Quick stand</b>	Ursus Mooi adjust

## COMFORT 32

Code	J403		
Size	Crank	Stem	Handlebar
S	170	150	640
M	170	150	640
L	170	150	640
XL	170	150	640



<b>Frame</b>	Comfort Mid Bar
<b>Fork</b>	SR Suntour XCE 80mm V-Brake QR
<b>Crankset</b>	Shimano TY301 28x38x48t
<b>Headset</b>	1-1/8" Semi-Integrated
<b>Handlebar</b>	Orbea City Riser Alu 640mm
<b>Stem</b>	Orbea Adjustable Alu
<b>Brakes</b>	Orbea V-Brake
<b>Rear Derailleur</b>	Shimano TY300
<b>Front Derailleur</b>	Shimano TY510 31.8mm
<b>Chain</b>	Z7 GYBR
<b>Wheels</b>	Orbea Scorpion DW
<b>Cassette</b>	Shimano HG200 12-32t 7-Speed
<b>Tyres</b>	Kenda K935 700x42 Reflective Logo
<b>Pedals</b>	VPE-537 Black

<b>Seatpost</b>	Orbea OC 27.2x400mm
<b>Saddle</b>	Selle Royal Milo Plus DR
<b>Quick stand</b>	Ursus Mooi adjust

## COMFORT 42

Code	J401		
Size	Crank	Stem	Handlebar
S	170	150	640
M	170	150	640
L	170	150	640
XL	170	150	640



<b>Frame</b>	Comfort Mid Bar
<b>Fork</b>	Orbea Hi-Ten V-Brake+Disc
<b>Crankset</b>	Pioneer Prowheel 42t
<b>Headset</b>	1-1/8" Semi-Integrated
<b>Handlebar</b>	Orbea City Riser Alu 640mm
<b>Stem</b>	Orbea Alu
<b>Shifters</b>	Shimano M310
<b>Brake levers</b>	Orbea Trekking Alu 4-finger
<b>Brakes</b>	Orbea V-Brake
<b>Rear Derailleur</b>	Shimano TY300
<b>Chain</b>	Z7 GYBR
<b>Wheels</b>	Orbea Scorpion DW
<b>Cassette</b>	Shimano TZ31 14-34t 7-Speed
<b>Tyres</b>	Kenda K935 700x42 Reflective Logo

<b>Pedals</b>	VPE-537 Black
<b>Seatpost</b>	Orbea OC 27.2x400mm
<b>Saddle</b>	Selle Royal One 6007 DR
<b>Quick stand</b>	Central alloy

## COMFORT 12 PACK

Code	J415		
Size	Crank	Stem	Handlebar
S	170	90	660
M	170	90	660
L	170	90	660
XL	170	90	660



<b>Frame</b>	Comfort Mid Bar
<b>Fork</b>	SR Suntour NEX E-25 63mm Disc
<b>Crankset</b>	Shimano M371 26x36x48t w/CG
<b>Headset</b>	1-1/8" Semi-Integrated
<b>Handlebar</b>	Orbea Comfort Riser Alu 660mm
<b>Stem</b>	Orbea Black Adjustable
<b>Shifters</b>	Shimano Deore M590
<b>Brakes</b>	Shimano MT200 Hydraulic Disc
<b>Rear Derailleur</b>	Shimano Deore M592 Shadow
<b>Front Derailleur</b>	Shimano Altus M370 31,8mm
<b>Chain</b>	Shimano HG53 9-Speed
<b>Wheels</b>	Mach1 ER20 19c
<b>Cassette</b>	Shimano HG200 11-36 9-Speed
<b>Tyres</b>	Kenda K935 1,65" Reflex

<b>Pedals</b>	VP-469 Black
<b>Seatpost</b>	Orbea 27.2x350mm w/Suspension
<b>Saddle</b>	Selle Royal Milo Plus DR
<b>Rear carrier</b>	PORTABULTOS DE ACERO PARA RUEDAS DE 26 Y 28 NEGRO
<b>Mudguard</b>	SKS 28"
<b>Front light</b>	Joss Spanninga Kendo XDAS Dinamo
<b>Rear light</b>	Joss Spanninga Lineo XDS Dinamo
<b>Dynamo</b>	Shimano DH-3D37-NT, 6V Dynamo 3.0W
<b>Lock</b>	Abus Pro Shield Plus frame lock
<b>Quick stand</b>	Ursus Mooi adjust

## COMFORT 22 PACK

Code	J413		
Size	Crank	Stem	Handlebar
S	170	150	640
M	170	150	640
L	170	150	640
XL	170	150	640



<b>Frame</b>	Comfort Mid Bar
<b>Fork</b>	SR Suntour XCE 80mm V-Brake QR
<b>Crankset</b>	Shimano M371 26x36x48t w/CG
<b>Headset</b>	1-1/8" Semi-Integrated
<b>Handlebar</b>	Orbea City Riser Alu 640mm
<b>Stem</b>	Orbea Adjustable Alu
<b>Shifters</b>	Shimano STEF 65 4-finger
<b>Brakes</b>	Shimano T4000 V-Brake
<b>Rear Derailleur</b>	Shimano Altus M2000 SGS Shadow
<b>Front Derailleur</b>	Shimano Altus M370 31,8mm
<b>Chain</b>	Shimano HG53 9-Speed
<b>Wheels</b>	Orbea Scorpion DW
<b>Cassette</b>	Shimano HG200 11-36 9-Speed
<b>Tyres</b>	Kenda K935 1,65" Reflex

<b>Pedals</b>	VP-469 Black
<b>Seatpost</b>	Orbea OC-1 27.2x400mm
<b>Saddle</b>	Selle Royal Milo Plus DR
<b>Rear carrier</b>	PORTABULTOS DE ACERO PARA RUEDAS DE 26 Y 28 NEGRO
<b>Mudguard</b>	SKS 28"
<b>Front light</b>	Joss Spanninga Kendo XDAS Dinamo
<b>Rear light</b>	Joss Spanninga Lineo XDS Dinamo
<b>Dynamo</b>	Shimano C3000 Dynamo
<b>Quick stand</b>	Ursus Mooi adjust

## COMFORT 32 PACK

Code	J411		
Size	Crank	Stem	Handlebar
S	170	150	640
M	170	150	640
L	170	150	640
XL	170	150	640



<b>Frame</b>	Comfort Mid Bar
<b>Fork</b>	SR Suntour XCE 80mm V-Brake QR
<b>Crankset</b>	Shimano TY301 28x38x48t
<b>Headset</b>	1-1/8" Semi-Integrated
<b>Handlebar</b>	Orbea City Riser Alu 640mm
<b>Stem</b>	Orbea Adjustable Alu
<b>Brakes</b>	Orbea V-Brake
<b>Rear Derailleur</b>	Shimano TY300
<b>Front Derailleur</b>	Shimano TY510 31.8mm
<b>Chain</b>	Z7 GYBR
<b>Wheels</b>	Orbea Scorpion DW
<b>Cassette</b>	Shimano HG200 12-32t 7-Speed
<b>Tyres</b>	Kenda K935 700x42 Reflective Logo
<b>Pedals</b>	VPE-537 Black

<b>Seatpost</b>	Orbea OC 27.2x400mm
<b>Saddle</b>	Selle Royal Milo Plus DR
<b>Rear carrier</b>	PORTABULTOS DE ACERO PARA RUEDAS DE 26 Y 28 NEGRO
<b>Mudguard</b>	Orbea SKS 28" Black
<b>Front light</b>	Joss Spanninga Kendo XDAS Dinamo
<b>Rear light</b>	Basta Riff
<b>Dynamo</b>	Shimano C3000 Dynamo
<b>Quick stand</b>	Ursus Mooi adjust

## COMFORT 42 PACK

Code	J409		
Size	Crank	Stem	Handlebar
S	170	150	640
M	170	150	640
L	170	150	640
XL	170	150	640



<b>Frame</b>	Comfort Mid Bar
<b>Fork</b>	Orbea Hi-Ten V-Brake+Disc
<b>Crankset</b>	Pioneer Prowheel 42t
<b>Headset</b>	1-1/8" Semi-Integrated
<b>Handlebar</b>	Orbea City Riser Alu 640mm
<b>Stem</b>	Orbea Alu
<b>Shifters</b>	Shimano M310
<b>Brake levers</b>	Orbea Trekking Alu 4-finger
<b>Brakes</b>	Orbea V-Brake
<b>Rear Derailleur</b>	Shimano TY300
<b>Chain</b>	Z7 GYBR
<b>Wheels</b>	Orbea Scorpion DW
<b>Cassette</b>	Shimano TZ31 14-34t 7-Speed
<b>Tyres</b>	Kenda K935 700x42 Reflective Logo

<b>Pedals</b>	VPE-537 Black
<b>Seatpost</b>	Orbea OC 27.2x400mm
<b>Saddle</b>	Selle Royal One 6007 DR
<b>Rear carrier</b>	PORTABULTOS DE ACERO PARA RUEDAS DE 26 Y 28 NEGRO
<b>Mudguard</b>	Orbea SKS 28" Black
<b>Front light</b>	Joss Spanninga Galeo XB Battery
<b>Rear light</b>	Basta Riff
<b>Quick stand</b>	Central alloy



**KIDS**

**GROW  
MX**



## THEY LOVE **VEHICLES** MORE THAN TOYS

Sometimes, objects go further. This is the case with Grow. It is a bike, but it also means feeling free, getting a nice breeze on your face while riding your first bike, going out on your bicycle for the first time (genuine adventure trips), feeling independent on your first vehicle ever, and many other experiences and sensations produced by the object itself.

**GROW**





**GROW IS A SYSTEM BASED  
IN A LEARNING PROCESS**

/ STEP 1 - Dynamic Balance and Handling

/ STEP 2 - Pedaling and Braking

**GROW IS LIGHTWEIGHT  
AND DURABLE**

/ Full Alloy Components

/ High Quality Components  
(Grow is a bike, not a toy)

/ Components Adapted for Children

**GROW SYSTEM**

/ The Bike Grows with Your Child

## GROW 0

SIZES	GROW 0
1 - Seat Tube (C-T)	153
3 - Head Tube	92
7 - Wheelbase	610
8 - Head Angle	70°
11 - Reach	266
12 - Stack	423
13 - Fork Length	195

HEIGHT (cm)	HEIGHT (in)	SIZE
85-105	33.5"-41.3"	GROW 0

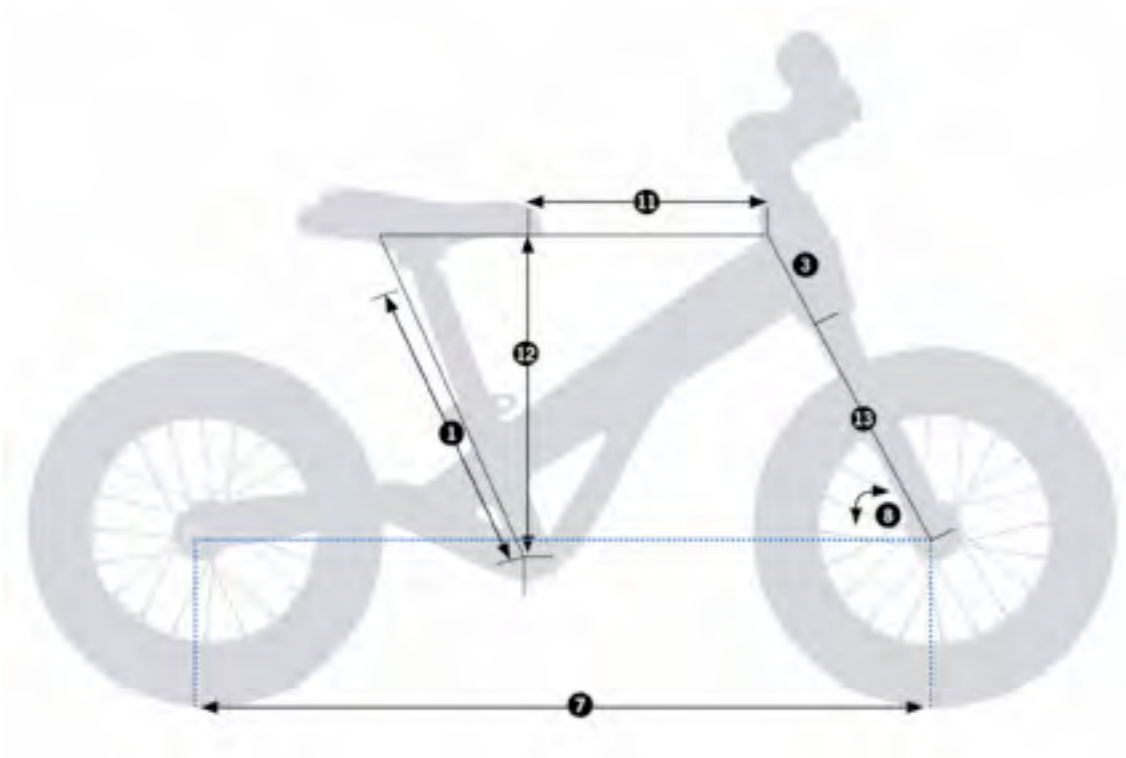

## GROW 1

SIZES	GROW 1
1 - Seat Tube (C-T)	202
3 - Head Tube	85
5 - BB Height	192
7 - Wheelbase	757 (+50)
8 - Head Angle	72.9°
11 - Reach	365 (+50)
12 - Stack	531
13 - Fork Length	274,5

HEIGHT (cm)	HEIGHT (in)	SIZE
95-115	37.4"-45.3"	GROW 1

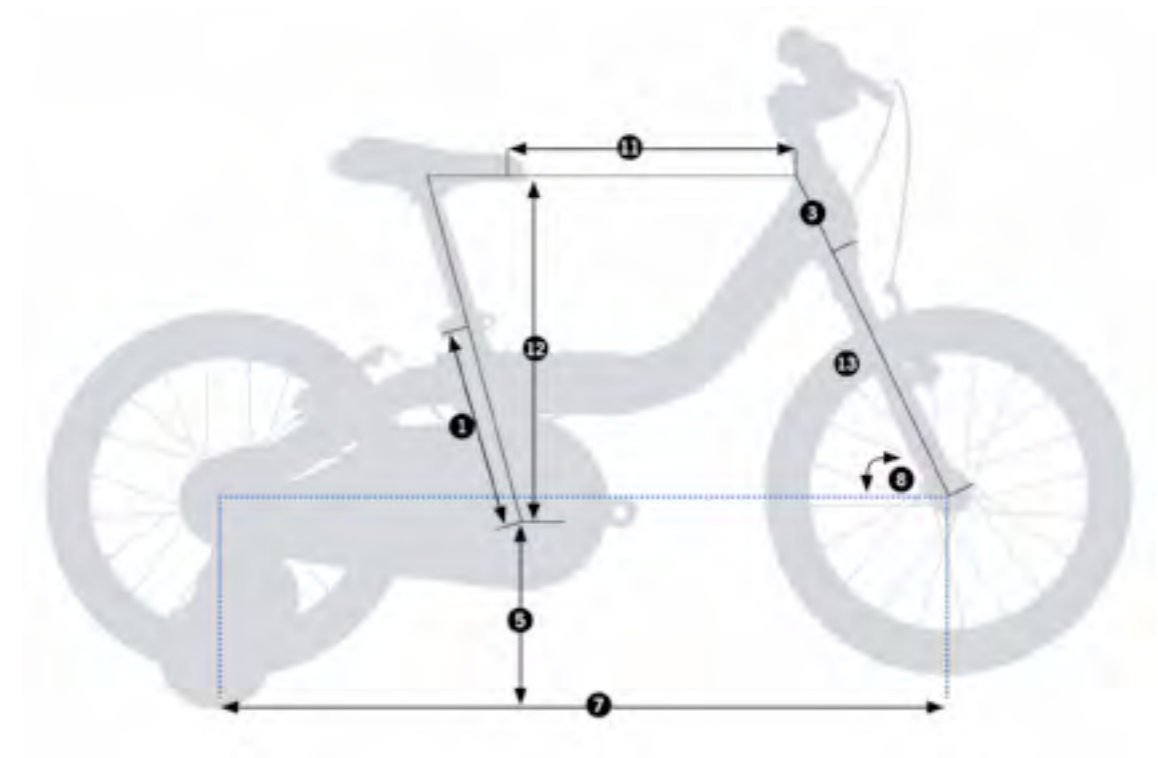

## GROW 2

SIZES	GROW 2
1 - Seat Tube (C-T)	261
3 - Head Tube	95
5 - BB Height	220
7 - Wheelbase	835 (+50)
8 - Head Angle	70.6°
11 - Reach	377 (+50)
12 - Stack	645
13 - Fork Length	335

HEIGHT (cm)	HEIGHT (in)	SIZE
110-135	43.3-53.1"	GROW 2

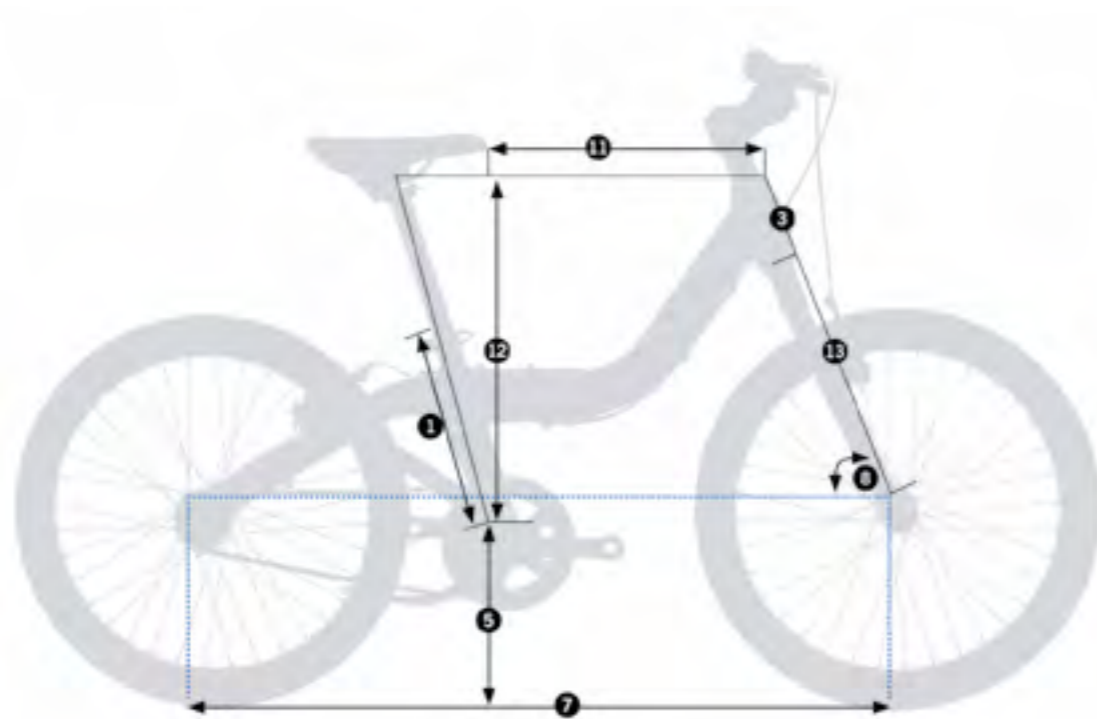

## GROW 0

Code	J001		
Size	Crank	Stem	Handlebar
16		70	400



<b>Frame</b>	Orbea Grow 12"
<b>Fork</b>	Orbea Hi-Ten 12"
<b>Headset</b>	1-1/8" Semi-Integrated
<b>Handlebar</b>	Orbea Alu Riser
<b>Stem</b>	Orbea Kid
<b>Wheels</b>	Orbea Alu 12"
<b>Tyres</b>	Kenda 841 12-1/2*2-1/4 Reflective Logo
<b>Seatpost</b>	Orbea Kid
<b>Saddle</b>	Velo 5086



## GROW 1

Code	J002		
Size	Crank	Stem	Handlebar
16	102	50	460



<b>Frame</b>	Orbea Grow 16"
<b>Fork</b>	Orbea Hi-Ten 16"
<b>Crankset</b>	Alloy 36t (102)
<b>Headset</b>	1-1/8" Semi-Integrated
<b>Handlebar</b>	Orbea Alu Riser
<b>Stem</b>	Orbea Kid
<b>Brake levers</b>	Alu V-Brake
<b>Brakes</b>	Alu V-Brake
<b>Chain</b>	KMC Single-Speed
<b>Wheels</b>	Orbea Alu 16"
<b>Cassette</b>	Orbea 18t
<b>Tyres</b>	Kenda 879 16x1,75" Reflective Logo
<b>Pedals</b>	Resine BMX
<b>Seatpost</b>	Orbea Kid

<b>Saddle</b>	Velo 5086
<b>Chainguard</b>	Orbea Chainguard



## GROW 2 1V

Code	J004		
Size	Crank	Stem	Handlebar
16	127	70	540



Frame	Orbea Grow 20"
Fork	Orbea Hi-Ten 20"
Crankset	Alloy 36t (127)
Headset	1-1/8" Semi-Integrated
Handlebar	Orbea Alu Riser
Stem	Orbea Kid
Brake levers	Alu V-Brake
Brakes	Alu V-Brake
Chain	KMC Single-Speed
Wheels	Orbea Alu 20"
Cassette	Orbea 18t
Tyres	Kenda 879 20x1,75" Reflective Logo
Pedals	Resine BMX
Seatpost	Orbea OC 27.2x250mm



Saddle	Velo 7087
--------	-----------

## GROW 2 7V

Code	J005		
Size	Crank	Stem	Handlebar
16	127	70	540



Frame	Orbea Grow 20"
Fork	Orbea Hi-Ten 20"
Crankset	Alloy 36t (127)
Headset	1-1/8" Semi-Integrated
Handlebar	Orbea Alu Riser
Stem	Orbea Kid
Shifters	Shimano M310
Brake levers	Orbea
Brakes	Alu V-Brake
Rear Derailleur	Shimano Altus M310
Chain	Z7 GYBR
Wheels	Orbea Alu 20"
Cassette	Shimano TZ31 14-34t 7-Speed
Tyres	Kenda 879 20x1,75" Reflective Logo



Pedals	Resine BMX
Seatpost	Orbea OC 27.2x250mm
Saddle	Velo 7087



## ANYONE CAN FEEL THE DIFFERENCE

We know the feeling... we all want our kids to fall in love with the freedom and joy of cycling. We want to ride with a smiling face next to us rather than watch our mini-friends struggle with an oversized, heavy, low-quality toy. With Orbea's MX Kids lineup, finding a real machine like yours that is scaled down for small riders becomes a reality. MX Kids bikes are among the lightest on the market and make use of smaller brake levers, saddles and pedals because comfort, control and fun aren't only for adults. Multiple wheel sizes, many configurations and, most importantly, a few color options make MX Kids the best catalyst for a growing passion. Nurturing a love of riding requires an investment and your child understands the significance of riding a bike just like yours. And with frames designed to last a lifetime, Your MX Kids bike will be ready for more kids whenever you are. But don't rush, enjoy your MX Kids bike together as long as you can before the moment slips away.

**MX**



**MINIPRO GEOMETRY**

- / Short Chainstays
- / Sloping Top Tube
- / Easy Handling
- / 1X Single Chainring

**MX IS LIGHTWEIGHT AND DURABLE**









- / Full Alloy Components
- / Components Adapted for Children



**MX KIDS**

SIZES	16	20	24
1 - Seat Tube (C-T)	207	257	329
2 - Top Tube (EFF)	385,3	445	519
3 - Head Tube	90	95	90
4 - Chainstay	311	343	387
5 - BB Height	192	237	272
6 - BB Drop	8	16	30
7 - Wheelbase	744	830	939
8 - Head Angle	71°	72°	66°
9 - Seat Angle	73.2°	73°	72°
10 - Standover	442	533	660
11 - Reach	288	320	353
12 - Stack	323	425	500
13 - Fork Length	255	345	420

HEIGHT (cm)	HEIGHT (in)	SIZE
100-115	31.5"-45.3"	16
115-135	45.3"-53.1"	20
135-155	53.1"-61.1"	24
>155	>61.1"	26

-  Yellow (Matt) **K8**
-  Turquoise (Matt) **K9**
-  Blue-Orange **KE**
-  Black-Pistachio (Matt) **KF**
-  Red-White (Gloss) **NF**
-  Black-Orange **KA**
-  Green-Yellow (Matt) **KD**
-  triangles (Gloss) **KB**

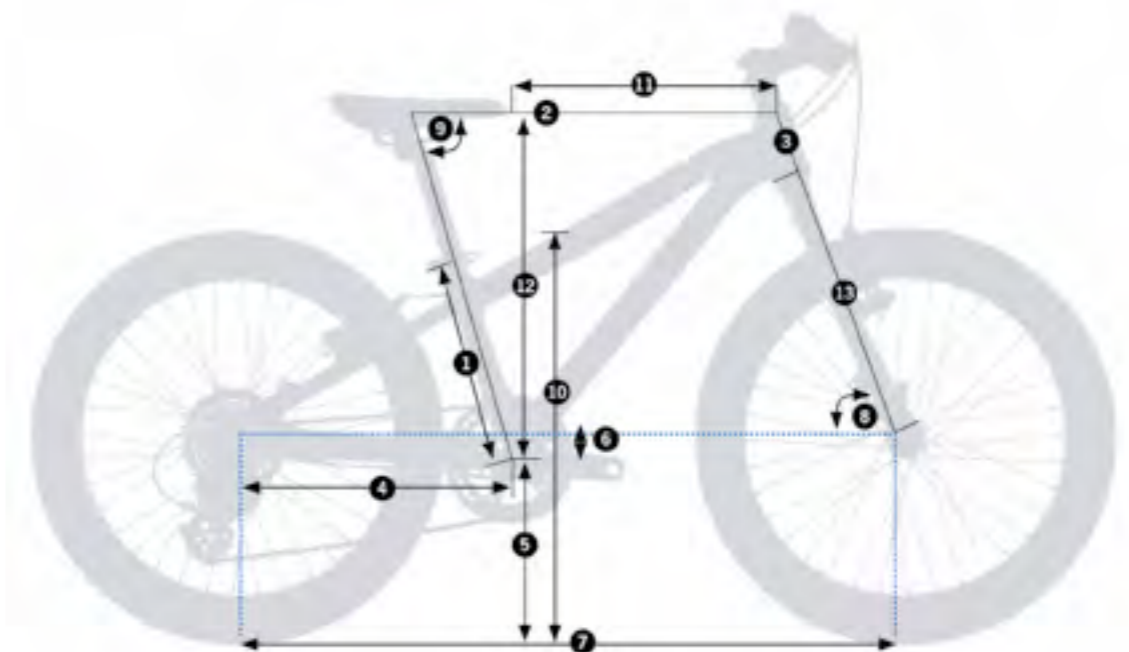

## MX 16

Code	J007		
Size	Crank	Stem	Handlebar
16	102	50	460



<b>Frame</b>	Orbea MX 16 Alu
<b>Fork</b>	Orbea Hi-Ten 16"
<b>Crankset</b>	Alloy 36t (102)
<b>Headset</b>	1-1/8" Semi-Integrated
<b>Handlebar</b>	Orbea Alu Riser
<b>Stem</b>	Orbea Kid
<b>Brake levers</b>	Alu V-Brake
<b>Brakes</b>	Alu V-Brake
<b>Chain</b>	KMC Single-Speed
<b>Wheels</b>	Orbea Alu 16"
<b>Cassette</b>	Orbea 18t
<b>Tyres</b>	Kenda 879 16x1,75" Reflective Logo
<b>Pedals</b>	Resine BMX
<b>Seatpost</b>	Orbea Kid

<b>Saddle</b>	Velo 5086
<b>Chainguard</b>	Sunny Wheel

## MX 20 DIRT

Code	J008		
Size	Crank	Stem	Handlebar
20	127	60	540



<b>Frame</b>	Orbea MX 20 Alu
<b>Fork</b>	Orbea Hi-Ten 20"
<b>Crankset</b>	Alloy 36t (127)
<b>Headset</b>	1-1/8" Semi-Integrated
<b>Handlebar</b>	Orbea Riser 540mm
<b>Stem</b>	Orbea Alu
<b>Shifters</b>	Shimano M310
<b>Brake levers</b>	Orbea
<b>Brakes</b>	Alu V-Brake
<b>Rear Derailleur</b>	Shimano Altus M310
<b>Chain</b>	Z7 GYBR
<b>Wheels</b>	Orbea Alu 20"
<b>Cassette</b>	Shimano TZ31 14-34t 7-Speed
<b>Tyres</b>	Kenda 922 20x2.00

<b>Pedals</b>	Resine BMX
<b>Seatpost</b>	Orbea OC 27.2x250mm
<b>Saddle</b>	Velo 7087

## MX 20 XC

Code	J009		
Size	Crank	Stem	Handlebar
20	127	70	540



<b>Frame</b>	Orbea MX 20 Alu
<b>Fork</b>	SR Suntour M3010 40mm V-Brake QR
<b>Crankset</b>	Alloy 36t (127)
<b>Headset</b>	1-1/8" Semi-Integrated
<b>Handlebar</b>	Orbea OC-I Riser 540mm
<b>Stem</b>	Orbea OC-II
<b>Shifters</b>	Shimano M310
<b>Brake levers</b>	Orbea
<b>Brakes</b>	Alu V-Brake
<b>Rear Derailleur</b>	Shimano Altus M310
<b>Chain</b>	Z7 GYBR
<b>Wheels</b>	Orbea Alu 20"
<b>Cassette</b>	Shimano TZ31 14-34t 7-Speed
<b>Tyres</b>	Kenda 922 20x2.00

<b>Pedals</b>	Resine BMX
<b>Seatpost</b>	Orbea OC 27.2x250mm
<b>Saddle</b>	Velo 7087

## MX 20 TEAM

Code	J011		
Size	Crank	Stem	Handlebar
20	127	70	540



<b>Frame</b>	Orbea MX 20 Alu
<b>Fork</b>	Orbea Alu 20"
<b>Crankset</b>	Alloy 34t (127)
<b>Headset</b>	1-1/8" Semi-Integrated
<b>Handlebar</b>	Orbea OC-I Riser 540mm
<b>Stem</b>	Orbea OC-II
<b>Shifters</b>	Shimano M310
<b>Brake levers</b>	Orbea
<b>Brakes</b>	Alu V-Brake
<b>Rear Derailleur</b>	Shimano Altus M310
<b>Chain</b>	Shimano HG53 9-Speed
<b>Wheels</b>	Orbea Alu 20"
<b>Cassette</b>	Shimano HG31 11-34t 8-Speed
<b>Tyres</b>	Kenda 1047 20x2,10" 60TPI Wire DTC

<b>Pedals</b>	Resine BMX
<b>Seatpost</b>	Orbea OC 27.2x250mm
<b>Saddle</b>	Velo 7087

## MX 20 TEAM DISC

Code	J013		
Size	Crank	Stem	Handlebar
20	127	70	540



<b>Frame</b>	Orbea MX 20 Alu only disc
<b>Fork</b>	Orbea Alu 20" only disc
<b>Crankset</b>	Alloy 34t (127)
<b>Headset</b>	1-1/8" Semi-Integrated
<b>Handlebar</b>	Orbea OC-I Riser 540mm
<b>Stem</b>	Orbea OC-II
<b>Shifters</b>	Shimano Altus M2000
<b>Brakes</b>	Shimano MT400 Hydraulic Disc
<b>Rear Derailleur</b>	Shimano Altus M2000 SGS Shadow
<b>Chain</b>	Shimano HG53 9-Speed
<b>Wheels</b>	Mach1 Klixx 23c Tubeless Ready
<b>Cassette</b>	Shimano HG200 11-36 9-Speed
<b>Tyres</b>	Kenda 1047 20x2,10" 60TPI Wire DTC
<b>Pedals</b>	Resine BMX

<b>Seatpost</b>	Orbea OC-I 27.2x250mm
<b>Saddle</b>	Velo 7087

## MX 20 PARK

Code	J014		
Size	Crank	Stem	Handlebar
20	127	60	540



<b>Frame</b>	Orbea MX 20 Alu
<b>Fork</b>	Orbea Hi-Ten 20"
<b>Crankset</b>	Alloy 36t (127)
<b>Headset</b>	1-1/8" Semi-Integrated
<b>Handlebar</b>	Orbea Riser 540mm
<b>Stem</b>	Orbea Alu
<b>Shifters</b>	Shimano M310
<b>Brake levers</b>	Orbea
<b>Brakes</b>	Alu V-Brake
<b>Rear Derailleur</b>	Shimano Altus M310
<b>Chain</b>	Z7 GYBR
<b>Wheels</b>	Orbea Alu 20"
<b>Cassette</b>	Shimano TZ31 14-34t 7-Speed
<b>Tyres</b>	Kenda 841 20x1.75 reflective tape

<b>Pedals</b>	Resine BMX
<b>Seatpost</b>	Orbea OC 27.2x250mm
<b>Saddle</b>	Velo 7087
<b>Mudguard</b>	SKS 20"
<b>Front light</b>	Joss Spanninga Galeo XB Battery
<b>Rear light</b>	PIXEO
<b>Quick stand</b>	Ursus 71 single centrall alloy



## MX 20 SPEED

Code	J015		
Size	Crank	Stem	Handlebar
20	127	60	540



<b>Frame</b>	Orbea MX 20 Alu
<b>Fork</b>	Orbea Hi-Ten 20"
<b>Crankset</b>	Alloy 36t (127)
<b>Headset</b>	1-1/8" Semi-Integrated
<b>Handlebar</b>	Orbea Riser 540mm
<b>Stem</b>	Orbea Alu
<b>Shifters</b>	Shimano M310
<b>Brake levers</b>	Orbea
<b>Brakes</b>	Alu V-Brake
<b>Rear Derailleur</b>	Shimano Altus M310
<b>Chain</b>	Z7 GYBR
<b>Wheels</b>	Orbea Alu 20"
<b>Cassette</b>	Shimano TZ31 14-34t 7-Speed
<b>Tyres</b>	Kenda 841 20x1.75 reflective tape

<b>Pedals</b>	Resine BMX
<b>Seatpost</b>	Orbea OC 27.2x250mm
<b>Saddle</b>	Velo 7087
<b>Quick stand</b>	Ursus 71 single centrall alloy



## MX 24 DIRT

Code	J016		
Size	Crank	Stem	Handlebar
24	152	60	540



<b>Frame</b>	Orbea MX 24 Alu
<b>Fork</b>	Orbea Hi-Ten 24"
<b>Crankset</b>	Alloy 36t (152)
<b>Headset</b>	1-1/8" Semi-Integrated
<b>Handlebar</b>	Orbea Riser 540mm
<b>Stem</b>	Orbea Alu
<b>Shifters</b>	Shimano M310
<b>Brake levers</b>	Orbea
<b>Brakes</b>	Alu V-Brake
<b>Rear Derailleur</b>	Shimano Altus M310
<b>Chain</b>	Z7 GYBR
<b>Wheels</b>	Orbea Alu 24"
<b>Cassette</b>	Shimano TZ31 14-34t 7-Speed
<b>Tyres</b>	Kenda 922 24x1.95

<b>Pedals</b>	Resine BMX
<b>Seatpost</b>	Orbea OC-I 27.2x300mm
<b>Saddle</b>	Velo 5061





## MX 24 XC

Code	J017		
Size	Crank	Stem	Handlebar
24	152	70	560



<b>Frame</b>	Orbea MX 24 Alu
<b>Fork</b>	SR Suntour M3010 40mm V-Brake QR
<b>Crankset</b>	Alloy 36t (152)
<b>Headset</b>	1-1/8" Semi-Integrated
<b>Handlebar</b>	Orbea OC-I Riser 560mm
<b>Stem</b>	Orbea OC-II
<b>Shifters</b>	Shimano M310
<b>Brake levers</b>	Orbea
<b>Brakes</b>	Alu V-Brake
<b>Rear Derailleur</b>	Shimano Altus M310
<b>Chain</b>	KMC X8
<b>Wheels</b>	Orbea Alu 24"
<b>Cassette</b>	Shimano HG31 11-34t 8-Speed
<b>Tyres</b>	Kenda 922 24x1.95

<b>Pedals</b>	Resine BMX
<b>Seatpost</b>	Orbea OC-I 27.2x300mm
<b>Saddle</b>	Velo 5061

## MX 24 TEAM

Code	J019		
Size	Crank	Stem	Handlebar
24	152	70	560



<b>Frame</b>	Orbea MX 24 Alu
<b>Fork</b>	Orbea Alu 24"
<b>Crankset</b>	Alloy 32t (152)
<b>Headset</b>	1-1/8" Semi-Integrated
<b>Handlebar</b>	Orbea OC-I Riser 560mm
<b>Stem</b>	Orbea OC-II
<b>Shifters</b>	Shimano Altus M2000
<b>Brake levers</b>	Orbea
<b>Brakes</b>	Alu V-Brake
<b>Rear Derailleur</b>	Shimano Altus M2000 SGS Shadow
<b>Chain</b>	Shimano HG53 9-Speed
<b>Wheels</b>	Orbea Alu 24"
<b>Cassette</b>	Shimano HG200 11-36 9-Speed
<b>Tyres</b>	Kenda 1047 24x2,10" 60TPI Wire DTC

<b>Pedals</b>	Resine BMX
<b>Seatpost</b>	Orbea OC-I 27.2x300mm
<b>Saddle</b>	Velo 5061

## MX 24 TEAM DISC

Code	J021		
Size	Crank	Stem	Handlebar
24	152	70	560



<b>Frame</b>	Orbea MX 24 Alu only disc
<b>Fork</b>	Orbea Alu 24" only disc
<b>Crankset</b>	Alloy 32t (152)
<b>Headset</b>	1-1/8" Semi-Integrated
<b>Handlebar</b>	Orbea OC-I Riser 560mm
<b>Stem</b>	Orbea OC-II
<b>Shifters</b>	Shimano Deore M6000
<b>Brakes</b>	Shimano MT400 Hydraulic Disc
<b>Rear Derailleur</b>	Shimano Deore M6000 GS Shadow Plus
<b>Chain</b>	Fsa Team Issue
<b>Wheels</b>	Mach1 Klixx 23c Tubeless Ready
<b>Cassette</b>	Shimano HG50 11-36t 10-Speed
<b>Tyres</b>	Kenda 1047 24x2,10" 60TPI Wire DTC
<b>Pedals</b>	Resine BMX

<b>Seatpost</b>	Orbea OC-I 27.2x300mm
<b>Saddle</b>	Velo 5061

## MX 24 TRAIL

Code	J022		
Size	Crank	Stem	Handlebar
24	152	70	560



<b>Frame</b>	Orbea MX 24 Alu only disc
<b>Fork</b>	SR Suntour XCR LO Air spring 63mm QR
<b>Crankset</b>	Alloy 32t (152)
<b>Headset</b>	1-1/8" Semi-Integrated
<b>Handlebar</b>	Orbea OC-I Riser 560mm
<b>Stem</b>	Orbea OC-II
<b>Shifters</b>	Shimano Deore M6000
<b>Brakes</b>	Shimano MT400 Hydraulic Disc
<b>Rear Derailleur</b>	Shimano Deore M6000 GS Shadow Plus
<b>Chain</b>	Fsa Team Issue
<b>Wheels</b>	Mach1 Klixx 23c Tubeless Ready
<b>Cassette</b>	Sun Race 11-42t 10-Speed
<b>Tyres</b>	Kenda 1047 24x2,10" 60TPI Wire DTC
<b>Pedals</b>	Resine BMX

<b>Seatpost</b>	Orbea OC-I 27.2x300mm
<b>Saddle</b>	Velo 5061

## MX 24 PARK

Code	J023		
Size	Crank	Stem	Handlebar
24	152	60	540



<b>Frame</b>	Orbea MX 24 Alu
<b>Fork</b>	Orbea Hi-Ten 24"
<b>Crankset</b>	Alloy 36t (152)
<b>Headset</b>	1-1/8" Semi-Integrated
<b>Handlebar</b>	Orbea Riser 540mm
<b>Stem</b>	Orbea Alu
<b>Shifters</b>	Shimano M310
<b>Brake levers</b>	Orbea
<b>Brakes</b>	Alu V-Brake
<b>Rear Derailleur</b>	Shimano Altus M310
<b>Chain</b>	Z7 GYBR
<b>Wheels</b>	Orbea Alu 24"
<b>Cassette</b>	Shimano TZ31 14-34t 7-Speed
<b>Tyres</b>	Kenda 841 24x1.75 reflective tape

<b>Pedals</b>	Resine BMX
<b>Seatpost</b>	Orbea OC-1 27.2x300mm
<b>Saddle</b>	Velo 5061
<b>Mudguard</b>	SKS 24"
<b>Front light</b>	Joss Spanninga Galeo XB Battery
<b>Rear light</b>	PIXEO
<b>Quick stand</b>	Ursus 71 single centrall alloy

## MX 24 SPEED

Code	J024		
Size	Crank	Stem	Handlebar
24	152	60	540



<b>Frame</b>	Orbea MX 24 Alu
<b>Fork</b>	Orbea Hi-Ten 24"
<b>Crankset</b>	Alloy 36t (152)
<b>Headset</b>	1-1/8" Semi-Integrated
<b>Handlebar</b>	Orbea Riser 540mm
<b>Stem</b>	Orbea Alu
<b>Shifters</b>	Shimano M310
<b>Brake levers</b>	Orbea
<b>Brakes</b>	Alu V-Brake
<b>Rear Derailleur</b>	Shimano Altus M310
<b>Chain</b>	Z7 GYBR
<b>Wheels</b>	Orbea Alu 24"
<b>Cassette</b>	Shimano TZ31 14-34t 7-Speed
<b>Tyres</b>	Kenda 841 24x1.75 reflective tape

<b>Pedals</b>	Resine BMX
<b>Seatpost</b>	Orbea OC-1 27.2x300mm
<b>Saddle</b>	Velo 5061
<b>Quick stand</b>	Ursus 71 single centrall alloy

## MX XS

SIZES	XS – 27.5"
1 - Seat Tube (C-T)	360
2 - Top Tube (EFF)	521
3 - Head Tube	95
4 - Chainstay	440
5 - BB Height	297
6 - BB Drop	53
7 - Wheelbase	1050
8 - Head Angle	68.5°
9 - Seat Angle	74.5°
10 - Standover	730
11 - Reach	360
12 - Stack	582
13 - Fork Length	490

HEIGHT (cm)	HEIGHT (in)	SIZE
145-160	57.1-63.0"	XS – 27.5"

- 

Black-Orange (Matt-Gloss)  
R1
- 

Black-Turquoise-Red (Matt)  
R3
- 

Pistachio-Black (Gloss)  
R4
- 

Red-Black (Gloss)  
R5

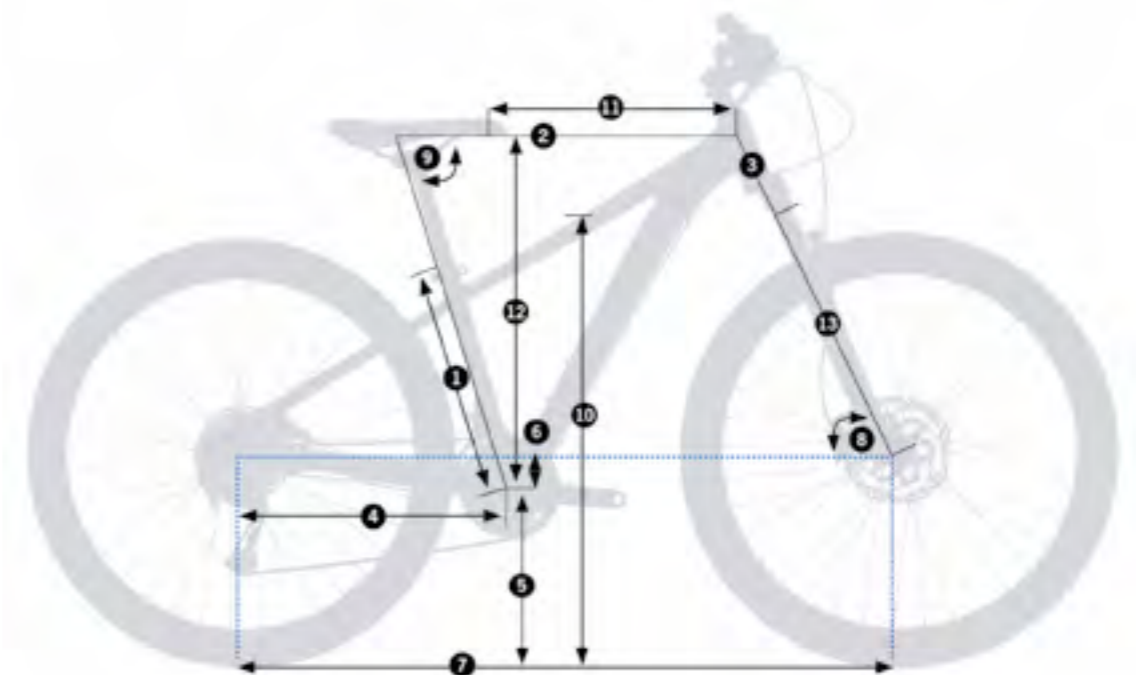

## MX 27 XS 40

Code	J027		
Size	Crank	Stem	Handlebar
27	170	70	720



<b>Frame</b>	Orbea MX Alu only disc
<b>Fork</b>	SR Suntour XCM RL-Coil 100mm QR
<b>Crankset</b>	Shimano MT100 22x30x40t
<b>Headset</b>	1-1/8" Semi-Integrated
<b>Handlebar</b>	Orbea OC-I Riser 720mm
<b>Stem</b>	Orbea OC-II
<b>Shifters</b>	Shimano Altus M2000
<b>Brakes</b>	Shimano MT200 Hydraulic Disc
<b>Rear Derailleur</b>	Shimano Altus M2000 SGS Shadow
<b>Front Derailleur</b>	Shimano Altus M2000 31,8mm
<b>Chain</b>	Shimano HG53 9-Speed
<b>Wheels</b>	Orbea Black Rock 23c Disc
<b>Cassette</b>	Shimano HG200 11-36 9-Speed
<b>Tyres</b>	Kenda K1153 2,35" 30TPI

<b>Pedals</b>	VPE-537 Black
<b>Seatpost</b>	Orbea OC-I 27.2x400mm
<b>Saddle</b>	Selle Royal 2062 HRN

## MX 27 XS 50

Code	J026		
Size	Crank	Stem	Handlebar
27	170	70	720



<b>Frame</b>	Orbea MX Alu only disc
<b>Fork</b>	SR Suntour XCT 30 Coil 100mm QR
<b>Crankset</b>	Shimano TY301 24x34x42t
<b>Headset</b>	1-1/8" Semi-Integrated
<b>Handlebar</b>	Orbea OC Riser 720mm
<b>Stem</b>	Orbea OC
<b>Shifters</b>	Shimano M310
<b>Brakes</b>	Shimano MT200 Hydraulic Disc
<b>Rear Derailleur</b>	Shimano Altus M310
<b>Front Derailleur</b>	Shimano Altus M313 31,8mm
<b>Chain</b>	KMC X8
<b>Wheels</b>	Mach1 ER20 19c
<b>Cassette</b>	Shimano HG200 12-32t 8-Speed
<b>Tyres</b>	Kenda K1153 2,35" 22TPI

<b>Pedals</b>	VPE-537 Black
<b>Seatpost</b>	Orbea OC 27.2x400mm
<b>Saddle</b>	Selle Royal 2073

## MX 27 XS 60

Code	J025		
Size	Crank	Stem	Handlebar
27	170	70	720



<b>Frame</b>	Orbea MX Alu only disc
<b>Fork</b>	SR Suntour XCE 28 Coil 100mm QR
<b>Crankset</b>	Shimano TY301 24x34x42t
<b>Headset</b>	1-1/8" Semi-Integrated
<b>Handlebar</b>	Orbea OC Riser 720mm
<b>Stem</b>	Orbea OC
<b>Shifters</b>	Shimano M310
<b>Brakes</b>	Shimano MT200 Hydraulic Disc
<b>Rear Derailleur</b>	Shimano TY300
<b>Front Derailleur</b>	Shimano Altus M313 31,8mm
<b>Chain</b>	Z7 GYBR
<b>Wheels</b>	Mach1 ER20 19c
<b>Cassette</b>	Shimano HG200 12-32t 7-Speed
<b>Tyres</b>	Kenda K1153 2,35" 22TPI

<b>Pedals</b>	VPE-537 Black
<b>Seatpost</b>	Orbea OC 27.2x400mm
<b>Saddle</b>	Selle Royal 2073

## MX ENTRANCE XS

SIZES	XS – 27.5"
1 - Seat Tube (C-T)	364
2 - Top Tube (EFF)	520
3 - Head Tube	96.5
4 - Chainstay	440
5 - BB Height	285
6 - BB Drop	60
7 - Wheelbase	1041
8 - Head Angle	68,5°
9 - Seat Angle	74°
11 - Reach	351
12 - Stack	590
13 - Fork Length	490

HEIGHT (cm)	HEIGHT (in)	SIZE
145-160	57.1-63.0"	XS – 27.5"



Black-Bright Red (Matt-Gloss)  
DV



Turquoise-Purple (Matt)  
DW

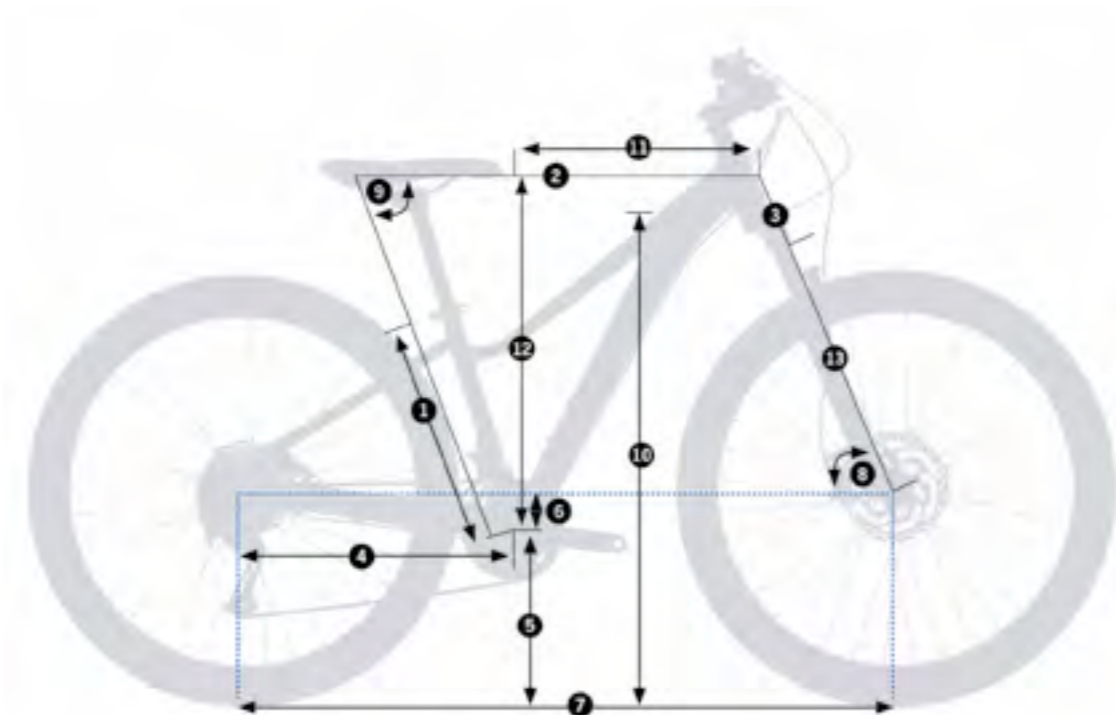

## MX 27 XS ENT 40

Code	J033		
Size	Crank	Stem	Handlebar
XS	170	70	720



Frame	Orbea MX Entrance only disc
Frame	
Fork	SR Suntour XCM RL-Coil 100mm QR
Crankset	Shimano MT100 22x30x40t
Headset	1-1/8" Semi-Integrated
Handlebar	Orbea OC-I Riser 720mm
Stem	Orbea OC-II
Shifters	Shimano Altus M2000
Brakes	Shimano MT200 Hydraulic Disc
Rear Derailleur	Shimano Altus M2000 SGS Shadow
Front Derailleur	Shimano Altus M2000 31,8mm
Chain	Shimano HG53 9-Speed
Wheels	Orbea Black Rock 23c Disc
Cassette	Shimano HG200 11-36 9-Speed



Tyres	Kenda K1153 2,35" 30TPI
Pedals	VPE-537 Black
Seatpost	Orbea OC-I 27,2x400mm
Saddle	Selle Royal 2062 HRN

## MX 27 XS ENT 50

Code	J032		
Size	Crank	Stem	Handlebar
XS	170	70	720



Frame	Orbea MX Entrance only disc
Frame	
Fork	SR Suntour XCT 30 Coil 100mm QR
Crankset	Shimano TY301 24x34x42t
Headset	1-1/8" Semi-Integrated
Handlebar	Orbea OC Riser 720mm
Stem	Orbea OC
Shifters	Shimano M310
Brakes	Shimano MT200 Hydraulic Disc
Rear Derailleur	Shimano Altus M310
Front Derailleur	Shimano Altus M313 31,8mm
Chain	KMC X8
Wheels	Mach1 ER20 19c
Cassette	Shimano HG200 12-32t 8-Speed



Tyres	Kenda K1153 2,35" 22TPI
Pedals	VPE-537 Black
Seatpost	Orbea OC 27,2x400mm
Saddle	Selle Royal 2073

## MX 27 XS ENT 60

<b>Code</b>	J031		
<b>Size</b>	<b>Crank</b>	<b>Stem</b>	<b>Handlebar</b>
XS	170	70	720



<b>Frame</b>	Orbea MX Entrance only disc
<b>Frame</b>	Orbea MX Alu Entrance only disc
<b>Fork</b>	SR Suntour XCE 28 Coil 100mm QR
<b>Crankset</b>	Shimano TY301 24x34x42t
<b>Headset</b>	1-1/8" Semi-Integrated
<b>Handlebar</b>	Orbea OC Riser 720mm
<b>Stem</b>	Orbea OC
<b>Shifters</b>	Shimano M310
<b>Brakes</b>	Shimano MT200 Hydraulic Disc
<b>Rear Derailleur</b>	Shimano TY300
<b>Front Derailleur</b>	Shimano Altus M313 31,8mm
<b>Chain</b>	Z7 GYBR
<b>Wheels</b>	Mach1 ER20 19c
<b>Cassette</b>	Shimano HG200 12-32t 7-Speed

<b>Tyres</b>	Kenda K1153 2,35" 22TPI
<b>Pedals</b>	VPE-537 Black
<b>Seatpost</b>	Orbea OC 27.2x400mm
<b>Saddle</b>	Selle Royal 2073

# ELECTRIC BIKES

ROAD  
MTB  
URBAN

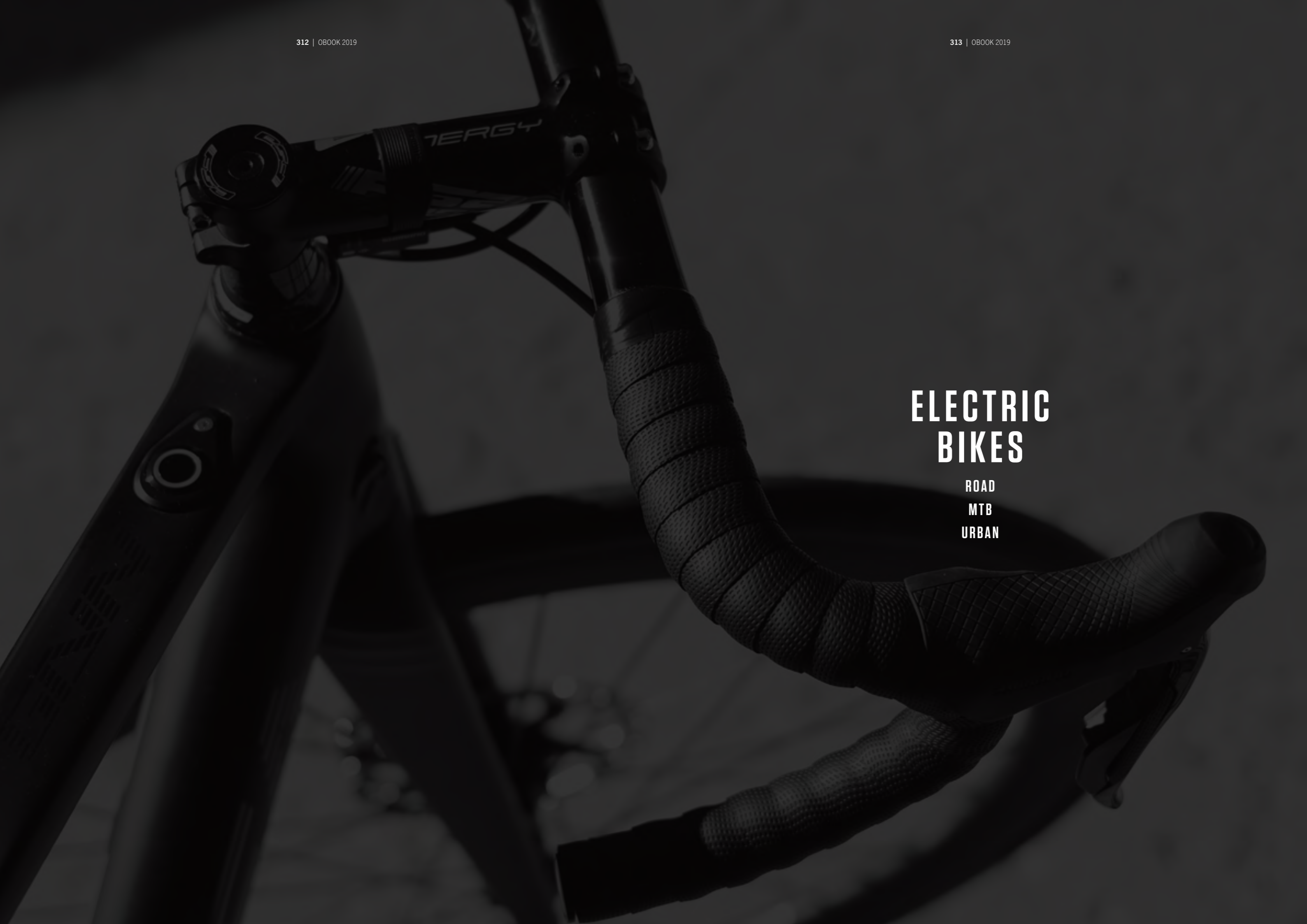



# ROAD

GAIN ROAD  
GAIN ALL ROAD



## ENHANCE YOUR RIDE

Gain was designed to enhance your ride, not dominate it. The Enough Power and Enough Energy concepts result in an exceptionally lightweight, sportive and rideable bike – a machine that heeds the call of the open road. Gain embraces your sweat and hard work and works in unison with your efforts to tick off the kilometers. System interfaces are modern, integrated and sleek. There are no bulky components to reduce the riding experience, distractions have been minimized so it's just you, Gain and the hours ahead.

**GAIN ROAD**





“THE LIGHTEST HYBRID,  
EVEN LIGHTER.

11,3KG



## GAIN ROAD TECH



01 MODE BUTTON

02 C.A.N. INTEGRATION

03 BATTERY

04 MOTOR

05 PAS SENSOR

### MODE BUTTON

Save space on your handlebar for a GPS if you wish, or ride without clutter. Gain's control center is an attractive and discreet button on the top tube. With the simple iWoc ONE interface you can power the system on or off, check motor assist level and view the remaining battery charge. Colored LED lighting puts all the information you need right at your fingertips.



### INTERNAL BATTERY

The battery is one of the most noticeable components of an eBike system, so every step has been taken to find the lightest, smallest and most discreet unit. Gain's Enough Energy concept provides you enough battery power, not more. It eliminates the need for a bulky, high-output battery that needs to be removed from the bike.

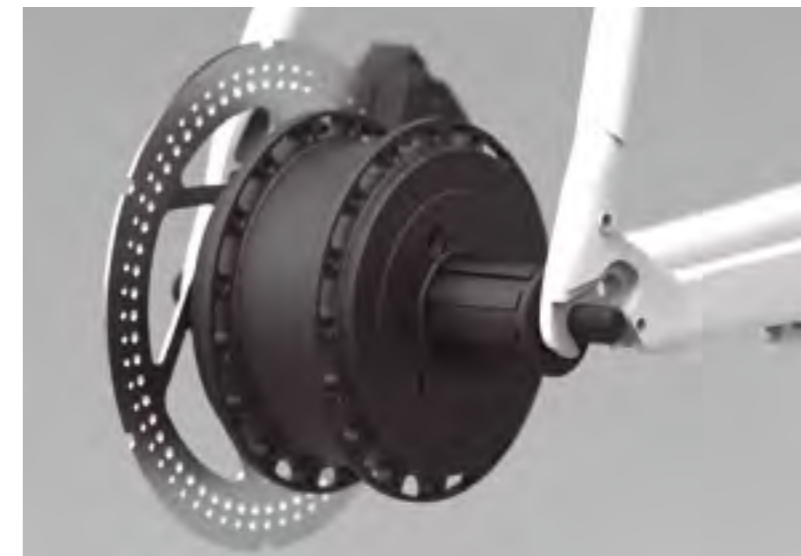

### DRIVE SYSTEM

The heart of Gain, the rear hub motor is the key to Gain's Enough Power concept. The sophisticated drive system provides enough smooth and reliable assistance at levels designed to enhance your ride, not dominate it. And since the motor is at the hub, you'll experience drag-free pedaling when Gain is not providing a push.



### C.A.N. INTEGRATION

Gain doesn't require a multitude of wires, ports or accessories. The CAN (Controller Area Network) bus port provides a single interface for charging, system diagnosis or attaching the external backup battery.



### SENSOR P.A.S.

Gain's smooth and balanced assist requires an advanced sensor. Blending perfectly with our effort to create a sleek and discrete system, the cassette lock ring holds 20 magnets that are detected by the integrated dropout sensor. The system monitors your pedaling input and adjusts power accordingly.

### APP

A smartphone and smartwatch compatible app enables deeper control of the iWoc system used by Gain. Ride tracking, activity and GPS route uploading and other functions are available from your mobile device, making Gain an even more valuable tool.



### VERSATILE

The new carbon frame includes the same integration features other Orbea carbon frames have, plus the complexity of also fully integrating the motor power cable and the P.A.S. sensor.





### MAVIC

In order to bring the best quality built, we've team up with Mavic and brought their bestsellers into the Gain family; the Aksium Elite and Cosmic Carbon wheels.



# AWARD WINNER

“THE ORBEA GAIN IS TRULY A REVOLUTION”.  
GRAN FONDO (GERMANY)

“THE FUTURE OF THE BICICLES?”  
BYCICLING

Myo

# DESIGN YOUR BIKE

- 01 CHOOSE A MODEL AND SELECT OR SUBSTITUTE YOUR FAVORITE COMPONENTS.
- 02 CREATE A CUSTOM PAINT SCHEME.
- 03 ADD YOUR NAME TO THE TOPE TUBE.

[WWW.ORBEA.COM](http://WWW.ORBEA.COM)

GAIN ALL ROAD



GAIN ALL ROAD TECH



- 01 MODE BUTTON
- 02 C.A.N. INTEGRATION
- 03 BATTERY
- 04 MOTOR
- 05 PAS SENSOR
- 06 VERSATILE

# GAIN CARBON

SIZES	XS	S	M	L	XL
1 - Seat Tube (C-T)	470	510	540	555	570
2 - Top Tube (EFF)	517,9	528	549,5	568,8	591
3 - Head Tube	98,7	115	130	142	155
4 - Chainstay	435	435	435	435	435
5 - BB Height	272	272	272	272	272
6 - BB Drop	67	67	67	67	67
7 - Wheelbase	1005,6	1016	1024,5	1034,9	1051,4
8 - Head Angle	69,5	69,5	71	71,9	72,5
9 - Seat Angle	72,4	72,4	72,4	72,4	72,4
10 - Standover	715				
11 - Reach	355	360,2	375,4	390	407,6
12 - Stack	515	530,2	550,1	565	579,5
13 - Fork Length	395	395	395	395	395

HEIGHT (cm)	HEIGHT (in)	SIZE
150-160	59.1"-63.0"	XS
160-170	63.0"-66.9"	S
170-180	66.9"-70.9"	M
180-190	70.9"-74.8"	L
190-200	74.8"-78.7"	XL

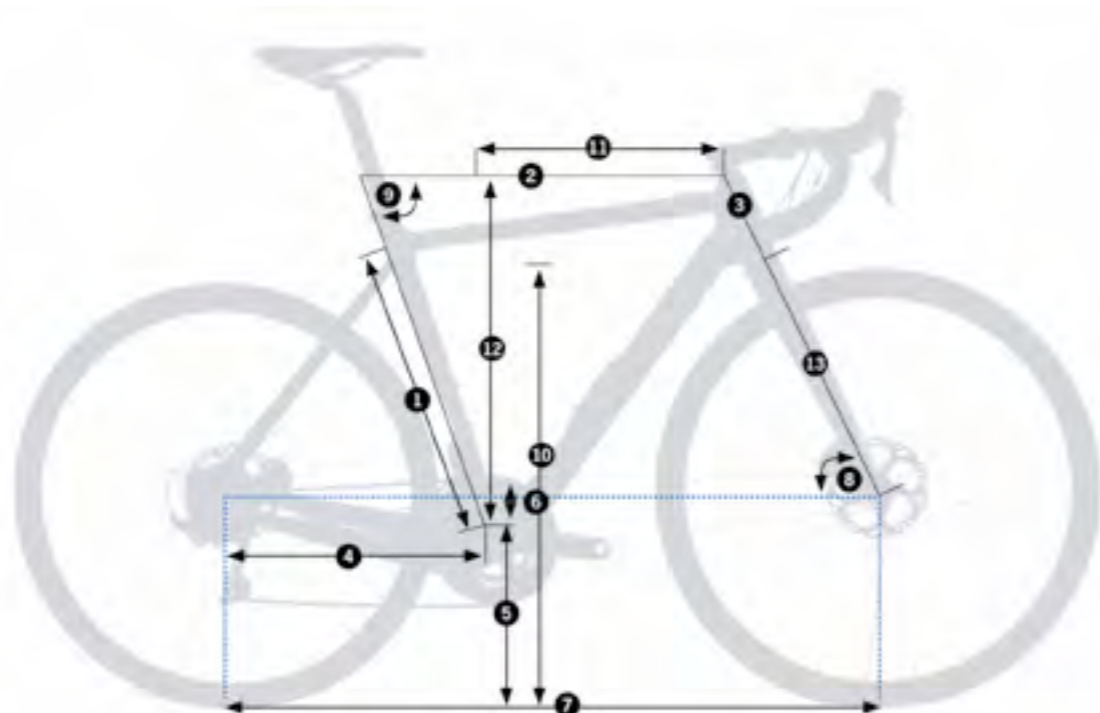

# GAIN M10

Code	J365		
Size	Crank	Stem	Handlebar
XS	170	90	400
S	170	100	420
M	170	100	420
L	172	110	440
XL	175	120	440



<b>Frame</b>	Orbea Gain Carbon
<b>Fork</b>	Gain Carbon Flat mount
<b>Crankset</b>	Shimano Dura-Ace 9100 34x50t
<b>Headset</b>	FSA 1-1/8 - 1-1/2" Integrated Carbon Cup ACB Bearings
<b>Handlebar</b>	FSA K-Force Compact
<b>Handlebar Plugs</b>	Black Anti-Slippery/Shock Proof Bar Tape
<b>Stem</b>	FSA OS-99 CSI
<b>Shifters</b>	Shimano R9120
<b>Brakes</b>	Shimano R9170 Hydraulic Disc
<b>Rear Derailleur</b>	Shimano Dura-Ace 9100
<b>Front Derailleur</b>	Shimano Dura-Ace 9100
<b>Chain</b>	Shimano HG901-11



<b>Wheels</b>	Mavic Cosmic Pro Carbon Disc UST
<b>Cassette</b>	Shimano Dura-Ace 9100 11-30t 11-Speed Shimano Dura-Ace R9100 11-28t 11-Speed
<b>Pedals</b>	N/A
<b>Seatpost</b>	FSA K-Force SB25 31.6x350mm Di2 compatible
<b>Saddle</b>	Prologo Nago Evo Space Tirox size 141mm Prologo Kappa Space STN size 147mm
<b>Motor</b>	Ebikemotion X35
<b>Battery</b>	Ebikemotion 36V/6.9A
<b>Remote 1</b>	Ebikemotion iWoc ONE

# GAIN M201

Code	J364		
Size	Crank	Stem	Handlebar
XS	170	90	380
S	170	100	420
M	170	100	420
L	172	110	440
XL	175	120	440



<b>Frame</b>	Orbea Gain Carbon
<b>Fork</b>	Gain Carbon Flat mount
<b>Crankset</b>	Shimano Ultegra R8000 34x50t
<b>Headset</b>	FSA 1-1/8 - 1-1/2" Integrated Carbon Cup ACB Bearings
<b>Handlebar</b>	FSA Energy Compact FSA K-Force Compact
<b>Handlebar Plugs</b>	Black Anti-Slippery/Shock Proof Bar Tape
<b>Stem</b>	FSA Energy FSA OS-99 CSI
<b>Shifters</b>	Shimano ST-8070
<b>Brakes</b>	Shimano R8070 Hydraulic Disc
<b>Rear Derailleur</b>	Shimano Ultegra Di2 R8050 GS



<b>Front Derailleur</b>	Shimano Ultegra Di2 R8050
<b>Chain</b>	KMC e11 Turbo Silver
<b>Wheels</b>	Mavic Aksium Elite Disc UST Mavic Cosmic Pro Carbon UST + Yksion Pro UST 28
<b>Cassette</b>	Shimano Ultegra R8000 11-32t 11-Speed Shimano Ultegra R8000 11-28t 11-Speed
<b>Tyres</b>	Mavic Yksion Pro 700x28 UST Hutchinson Fusion 5 All Season TLR 700x25
<b>Pedals</b>	N/A
<b>Seatpost</b>	FSA K-Force SB25 31.6x350mm Di2 compatible
<b>Saddle</b>	Prologo Kappa Space STN size 147mm Prologo Nago Evo Space Tirox size 141mm

<b>Motor</b>	Ebikemotion X35
<b>Battery</b>	Ebikemotion 36V/6.9A
<b>Remote 1</b>	Ebikemotion iWoc ONE

## GAIN M20



Code	J363		
Size	Crank	Stem	Handlebar
XS	170	90	380
S	170	100	420
M	170	100	420
L	172	110	440
XL	175	120	440



<b>Frame</b>	Orbea Gain Carbon
<b>Fork</b>	Gain Carbon Flat mount
<b>Crankset</b>	Shimano Ultegra R8000 34x50t
<b>Headset</b>	FSA 1-1/8 - 1-1/2" Integrated Carbon Cup ACB Bearings
<b>Handlebar</b>	FSA Energy Compact FSA K-Force Compact
<b>Handlebar Plugs</b>	Black Anti-Slippery/Shock Proof Bar Tape
<b>Stem</b>	FSA Energy FSA OS-99 CSI
<b>Shifters</b>	Shimano ST-8020
<b>Brakes</b>	Shimano R8070 Hydraulic Disc
<b>Rear Derailleur</b>	Shimano Ultegra R8000 GS

<b>Front Derailleur</b>	Shimano Ultegra R8000
<b>Chain</b>	KMC e11 Turbo Silver
<b>Wheels</b>	Mavic Aksium Elite Disc UST Mavic Cosmic Pro Carbon UST + Yksion Pro UST 28
<b>Cassette</b>	Shimano Ultegra R8000 11-32t 11-Speed Shimano Ultegra R8000 11-28t 11-Speed
<b>Tyres</b>	Mavic Yksion Pro 700x28 UST Hutchinson Fusion 5 All Season TLR 700x25
<b>Pedals</b>	N/A
<b>Seatpost</b>	Orbea OC-III Carbon 31.6x350mm FSA K-Force SB25 31.6x350mm Di2 compatible
<b>Saddle</b>	Prologo Kappa Space STN size 147mm

	Prologo Nago Evo Space Tirox size 141mm
<b>Motor</b>	Ebikemotion X35
<b>Battery</b>	Ebikemotion 36V/6.9A
<b>Remote 1</b>	Ebikemotion iWoc ONE

## GAIN M30



Code	J362		
Size	Crank	Stem	Handlebar
XS	170	90	380
S	170	100	420
M	170	100	420
L	172	110	440
XL	175	110	440



<b>Frame</b>	Orbea Gain Carbon
<b>Fork</b>	Gain Carbon Flat mount
<b>Crankset</b>	Shimano 105 R7000 34x50t
<b>Headset</b>	FSA 1-1/8 - 1-1/2" Integrated Carbon Cup ACB Bearings
<b>Handlebar</b>	FSA Gossamer Compact FSA Energy Compact
<b>Handlebar Plugs</b>	Black Anti-Slippery/Shock Proof Bar Tape
<b>Stem</b>	Orbea OC-III FSA Energy
<b>Shifters</b>	Shimano ST-7020
<b>Brakes</b>	Shimano R7070 Hydraulic Disc
<b>Rear Derailleur</b>	Shimano 105 R7000 GS

<b>Front Derailleur</b>	Shimano 105 R7000
<b>Chain</b>	KMC e11 Turbo Silver
<b>Wheels</b>	Mavic Aksium Elite Disc UST Mavic Cosmic Pro Carbon UST + Yksion Pro UST 28
<b>Cassette</b>	Shimano 105 R7000 11-32t 11-Speed
<b>Tyres</b>	Mavic Yksion Pro 700x28 UST Hutchinson Fusion 5 All Season TLR 700x25
<b>Pedals</b>	N/A
<b>Seatpost</b>	Orbea OC-III Carbon 31.6x350mm
<b>Saddle</b>	Prologo Kappa Space STN size 147mm Prologo Nago Evo Space Tirox size 141mm
<b>Motor</b>	Ebikemotion X35
<b>Battery</b>	Ebikemotion 36V/6.9A

<b>Remote1</b>	Ebikemotion iWoc ONE
----------------	----------------------

## GAIN M21



Code	J366		
Size	Crank	Stem	Handlebar
XS	170	90	400
S	170	100	420
M	170	100	420
L	172	110	440
XL	175	120	440



<b>Frame</b>	Orbea Gain Carbon
<b>Fork</b>	Gain Carbon Flat mount
<b>Headset</b>	FSA 1-1/8 - 1-1/2" Integrated Carbon Cup ACB Bearings
<b>Handlebar</b>	FSA Energy Compact FSA K-Force Compact
<b>Handlebar Plugs</b>	Black Anti-Slippery/Shock Proof Bar Tape
<b>Stem</b>	FSA Energy FSA OS-99 CSI
<b>Shifters</b>	SRAM Force
<b>Brakes</b>	SRAM Force Hydraulic
<b>Rear Derailleur</b>	SRAM Force 1
<b>Chain</b>	KMC e11 Turbo Silver

<b>Wheels</b>	Mavic Aksium Elite Disc UST Mavic Cosmic Pro Carbon UST + Gravel UST 40
<b>Cassette</b>	SRAM Force PG-1170 11-36t 11-Speed
<b>Tyres</b>	Mavic Gravel 700x40 UST Hutchinson Fusion 5 All Season TLR 700x25 Hutchinson Fusion 5 All Season TLR 700x28
<b>Pedals</b>	N/A
<b>Seatpost</b>	Orbea OC-III Carbon 31.6x350mm FSA K-Force SB25 31.6x350mm Di2 compatible
<b>Saddle</b>	Prologo Kappa Space STN size 147mm Prologo Nago Evo Space Tirox size 141mm

<b>Motor</b>	Ebikemotion X35
<b>Battery</b>	Ebikemotion 36V/6.9A
<b>Remote 1</b>	Ebikemotion iWoc ONE

# GAIN H

SIZES	XS	S	M	L	XL
1 - Seat Tube (C-T)	460	510	555	585	610
2 - Top Tube (EFF)	526	544	560	572	595
3 - Head Tube	109	126	150	176	203
4 - Chainstay	430	430	430	430	430
5 - BB Height	70	70	68	68	66
6 - BB Drop	281	281	283	283	285
7 - Wheelbase	1016	1022	1037	1051	1067
8 - Head Angle	71	72	72	72	72,3
9 - Seat Angle	74,5	74	74	74	73,5
11 - Reach	378	387	395	402	410
12 - Stack	535	555	575	600	625
13 - Fork Length	400	400	400	400	400

HEIGHT (cm)	HEIGHT (in)	SIZE
<160	<63.0"	XS
160-170	63.0"-66.9"	S
170-180	66.9"-70.9"	M
180-190	70.9"-74.8"	L
>190	>74.8"	XL

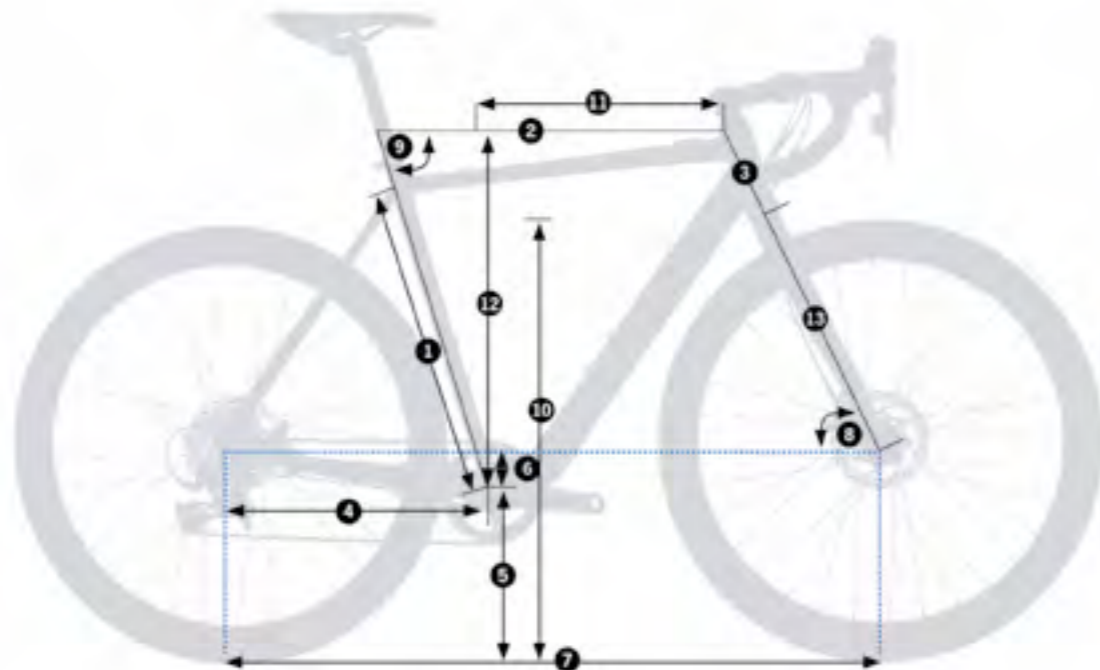
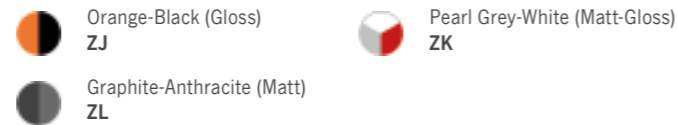

# GAIN D20



Code	J359		
Size	Crank	Stem	Handlebar
XS	170	90	400
S	170	100	420
M	170	100	420
L	172	110	440
XL	175	120	440



<b>Frame</b>	Orbea Gain
<b>Fork</b>	Speed 400mm Carbon Flat mount
<b>Crankset</b>	Shimano Ultegra R8000 34x50t
<b>Headset</b>	1-1/8" Semi-Integrated
<b>Handlebar</b>	FSA Energy Compact FSA K-Force Compact
<b>Handlebar Plugs</b>	Black Anti-Slippery/Shock Proof Bar Tape
<b>Stem</b>	FSA Energy FSA OS-99 CSI
<b>Shifters</b>	Shimano ST-8020
<b>Brakes</b>	Shimano R8070 Hydraulic Disc
<b>Rear Derailleur</b>	Shimano Ultegra R8000 GS
<b>Front Derailleur</b>	Shimano Ultegra R8000



<b>Chain</b>	KMC e11 Turbo Silver
<b>Wheels</b>	Ready GR Mavic Cosmic Pro Carbon UST + Yksion Pro UST 28
<b>Cassette</b>	Shimano Ultegra R8000 11-32t 11-Speed
<b>Tyres</b>	Hutchinson Fusion 5 All Season TLR 700x28 Hutchinson Fusion 5 All Season TLR 700x25
<b>Pedals</b>	N/A
<b>Seatpost</b>	FSA SL-K SB20 27.2x350mm Di2 compatible FSA K-Force SB25 27.2x350mm Di2 compatible
<b>Saddle</b>	Prologo Kappa Space STN size 147mm
<b>Motor</b>	Ebikemotion X35

<b>Battery</b>	Ebikemotion 36V/6.9A
<b>Remote 1</b>	Ebikemotion iWoc ONE

# GAIN D30



Code	J358		
Size	Crank	Stem	Handlebar
XS	170	90	400
S	170	100	420
M	170	100	420
L	172	110	440
XL	175	120	440



<b>Frame</b>	Orbea Gain
<b>Fork</b>	Speed 400mm Carbon Flat mount
<b>Crankset</b>	Shimano 105 R7000 34x50t
<b>Headset</b>	1-1/8" Semi-Integrated
<b>Handlebar</b>	FSA Gossamer Compact FSA Energy Compact
<b>Handlebar Plugs</b>	Black Anti-Slippery/Shock Proof Bar Tape
<b>Stem</b>	Orbea OC-III FSA Energy
<b>Shifters</b>	Shimano ST-7020
<b>Brakes</b>	Shimano R7070 Hydraulic Disc
<b>Rear Derailleur</b>	Shimano 105 R7000 GS
<b>Front Derailleur</b>	Shimano 105 R7000



<b>Chain</b>	KMC e11 Turbo Silver
<b>Wheels</b>	Ready GR Mavic Cosmic Pro Carbon UST + Yksion Pro UST 28
<b>Cassette</b>	Shimano 105 R7000 11-32t 11-Speed
<b>Tyres</b>	Hutchinson Fusion 5 All Season TLR 700x28 Hutchinson Fusion 5 All Season TLR 700x25
<b>Pedals</b>	N/A
<b>Seatpost</b>	FSA SL-K SB20 27.2x350mm Di2 compatible
<b>Saddle</b>	Prologo Kappa Space STN size 147mm
<b>Motor</b>	Ebikemotion X35
<b>Battery</b>	Ebikemotion 36V/6.9A

<b>Remote 1</b>	Ebikemotion iWoc ONE
-----------------	----------------------



## GAIN D40

MyO<sub>2.0</sub>

Code	J357		
Size	Crank	Stem	Handlebar
XS	170	90	400
S	170	100	420
M	170	100	420
L	172	110	440
XL	175	120	440



<b>Frame</b>	Orbea Gain
<b>Fork</b>	Speed 400mm Carbon Flat mount
<b>Crankset</b>	Shimano Tiagra 4700 34x50t
<b>Headset</b>	1-1/8" Semi-Integrated
<b>Handlebar</b>	FSA Omega Compact
	FSA Energy Compact
<b>Handlebar Plugs</b>	Black Anti-Slippery/Shock Proof Bar Tape
<b>Stem</b>	Orbea OC-II
	FSA Energy
<b>Shifters</b>	Shimano ST-RS405
<b>Brakes</b>	Shimano RS405 Hydraulic Disc
<b>Rear Derailleur</b>	Shimano Tiagra 4700 GS
<b>Front Derailleur</b>	Shimano Tiagra 4700

<b>Chain</b>	KMC e10 Turbo Silver
<b>Wheels</b>	Ready GR
<b>Cassette</b>	Shimano Tiagra HG-500 11-32t 10-Speed
<b>Tyres</b>	Hutchinson Fusion 5 All Season TLR 700x28
	Hutchinson Fusion 5 All Season TLR 700x25
<b>Pedals</b>	N/A
<b>Seatpost</b>	Orbea OC-III Carbon 27.2x350mm
	FSA SL-K SB20 27.2x350mm Di2 compatible
<b>Saddle</b>	Prologo Kappa Space STN size 147mm
<b>Motor</b>	Ebikemotion X35
<b>Battery</b>	Ebikemotion 36V/6.9A
<b>Remote 1</b>	Ebikemotion iWoc ONE

## GAIN D50

MyO<sub>2.0</sub>

Code	J356		
Size	Crank	Stem	Handlebar
XS	170	90	400
S	170	100	420
M	170	100	420
L	170	110	440
XL	170	120	440



<b>Frame</b>	Orbea Gain
<b>Fork</b>	Speed 400mm Carbon Flat mount
<b>Crankset</b>	Shimano Claris R2000 34x50t
<b>Headset</b>	1-1/8" Semi-Integrated
<b>Handlebar</b>	Orbea OC-II
	FSA Energy Compact
<b>Handlebar Plugs</b>	Bar Tape
	Black Anti-Slippery/Shock Proof Bar Tape
<b>Stem</b>	Orbea OC-II
	FSA Energy
<b>Shifters</b>	Shimano Claris ST-R2000
<b>Brakes</b>	Shimano BR-RS305 Mechanical Disc
<b>Rear Derailleur</b>	Shimano Claris RD-R2000-GS

<b>Front Derailleur</b>	Shimano Claris FD-R2000-F
<b>Chain</b>	KMC X8
<b>Wheels</b>	Ready GR
<b>Cassette</b>	Shimano HG50 11-32t 8-Speed
<b>Tyres</b>	Hutchinson Fusion 5 All Season TLR 700x28
	Hutchinson Fusion 5 All Season TLR 700x25
<b>Pedals</b>	N/A
<b>Seatpost</b>	Orbea OC-I 27.2x350mm
	FSA SL-K SB20 27.2x350mm Di2 compatible
<b>Saddle</b>	Selle Royal Seta RS
	Prologo Kappa Space STN size 147mm
<b>Motor</b>	Ebikemotion X35

<b>Battery</b>	Ebikemotion 36V/6.9A
<b>Remote 1</b>	Ebikemotion iWoc ONE

## GAIN D21

MyO<sub>2.0</sub>

Code	J361		
Size	Crank	Stem	Handlebar
XS	170	90	400
S	170	100	420
M	170	100	420
L	172	110	440
XL	175	120	440



<b>Frame</b>	Orbea Gain
<b>Fork</b>	Speed 400mm Carbon Flat mount
<b>Headset</b>	1-1/8" Semi-Integrated
<b>Handlebar</b>	FSA Energy Compact
	FSA K-Force Compact
<b>Handlebar Plugs</b>	Black Anti-Slippery/Shock Proof Bar Tape
<b>Stem</b>	FSA Energy
	FSA OS-99 CSI
<b>Shifters</b>	SRAM Force
<b>Brakes</b>	SRAM Force Hydraulic
<b>Rear Derailleur</b>	SRAM Force 1
<b>Chain</b>	KMC e11 Turbo Silver
<b>Wheels</b>	Ready GR

	Mavic Cosmic Pro Carbon UST + Gravel UST 40
<b>Cassette</b>	SRAM Force PG-1170 11-36t 11-Speed
<b>Tyres</b>	Schwalbe G-ONE Allround, 40-622, Black, Folding
	Hutchinson Fusion 5 All Season TLR 700x28
<b>Pedals</b>	N/A
<b>Seatpost</b>	FSA SL-K SB20 27.2x350mm Di2 compatible
	FSA K-Force SB25 27.2x350mm Di2 compatible
<b>Saddle</b>	Prologo Kappa Space STN size 147mm
<b>Motor</b>	Ebikemotion X35
<b>Battery</b>	Ebikemotion 36V/6.9A
<b>Remote 1</b>	Ebikemotion iWoc ONE

## GAIN D31

MyO<sub>2.0</sub>

Code	J360		
Size	Crank	Stem	Handlebar
XS	170	90	400
S	170	100	420
M	170	100	420
L	172	110	440
XL	175	120	440



<b>Frame</b>	Orbea Gain
<b>Fork</b>	Speed 400mm Carbon Flat mount
<b>Crankset</b>	SRAM Rival 40t
<b>Headset</b>	1-1/8" Semi-Integrated
<b>Handlebar</b>	FSA Gossamer Compact
<b>Handlebar Plugs</b>	Black Anti-Slippery/Shock Proof Bar Tape
<b>Stem</b>	Orbea OC-III
<b>Shifters</b>	SRAM Rival
<b>Brakes</b>	SRAM Rival Hydraulic
<b>Rear Derailleur</b>	SRAM Rival 1 X-Horizon
<b>Chain</b>	KMC e11 Turbo Silver
<b>Wheels</b>	Ready GR
<b>Cassette</b>	SRAM Rival PG-1130 11-36t 11-Speed

<b>Tyres</b>	Schwalbe G-ONE Allround, 40-622, Black, Folding
	Hutchinson Fusion 5 All Season TLR 700x28
<b>Pedals</b>	N/A
<b>Seatpost</b>	FSA SL-K SB20 27.2x350mm Di2 compatible
<b>Saddle</b>	Prologo Kappa Space STN size 147mm
<b>Motor</b>	Ebikemotion X35
<b>Battery</b>	Ebikemotion 36V/6.9A
<b>Remote 1</b>	Ebikemotion iWoc ONE



# MTB

WILD FS / WILD HT  
KERAM MTB



## TAKE BACK YOUR WILD

It's time to get moving. Load up your pack for an afternoon ride and start pedaling. Whatever obstacles exist between you and the trails and your Special Places, it's time to remove those impediments. Reclaim access and discover new adventures the way you like – aboard a fun and capable machine that enhances your skills while it extends your range. Conquer steep climbs and push the limits of traction and good judgment on the way back down. Enjoy clever design and sophisticated suspension kinematics, or simply focus on the trail. Wild FS revitalizes your riding and helps you chart new destinations. Take back control – Take back your Wild.

**WILD FS / WILD HT**



“**SCORE: 9/10**

BTT FRANCE

“**ORBEA'S NEW EBIKE IS FUN, EFFECTIVE, MANAGEABLE AND HAS A HUGE RANGE OF USE”.**

MTB PRO

## WILD FS TECH



01 HYDEOUT TECHNOLOGY

02 ADVANCED DYNAMICS

03 MOTOR

04 DISPLAY

05 EMTB COMPONENTS



## HIDEOUT TECHNOLOGY

Pay attention to the battery used by the ebike you choose. Opt for the least bulky one with the same capacity (500 Wh).

Besides being easy to remove, replace and transport, look for a battery with proven reliability that is not set to be replaced by a new generation in the near future.

/ Integrated battery fits smoothly with the frame shapes for great protection and a sleek appearance.

/ Tool-less battery access for convenience with a highly protected, rubber shielded charging port.

/ External access to battery on/off button and battery status.



### ADVANCED DYNAMICS



/ Orbea's design process that optimizes suspension characteristics and kinematics for the widest range of riding conditions.

/ 140mm front and rear travel.

/ High quality sealed cartridge pivot bearings for durability and sensitivity.



### DISPLAY

/ Compact display fits easily with other controls on the handlebar.

/ Color display is bluetooth/ant+ compatible.

### MOTOR SHIMANO E8000 AVAILABLE IN WILD HT Y FS

/ The lightest and most compact motor on the market.

/ Uses a standard chainring.

/ Speed sensor integrated with rear dropout.

/ The form of the E8000 motor allows for more desirable geometry and kinematics.

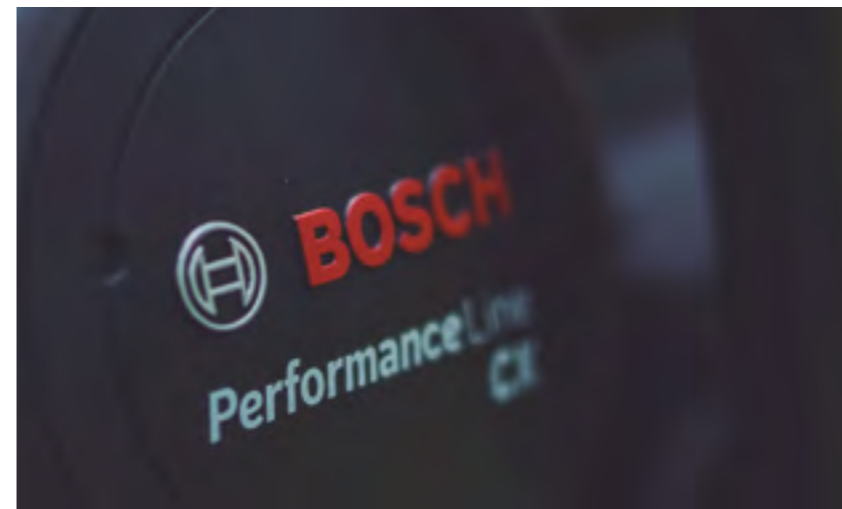

### MOTOR BOSCH PERFORMANCE CX + POWERTUBE 500 WH AVAILABLE IN WILD HT

/ New eMTB mode.

/ Internal 500 Wh battery.

/ Minimalist design with the most compact and light battery on the market.

/ Charges both with the battery in and out of the bike.

/ Double density cover for an optimal battery protection.

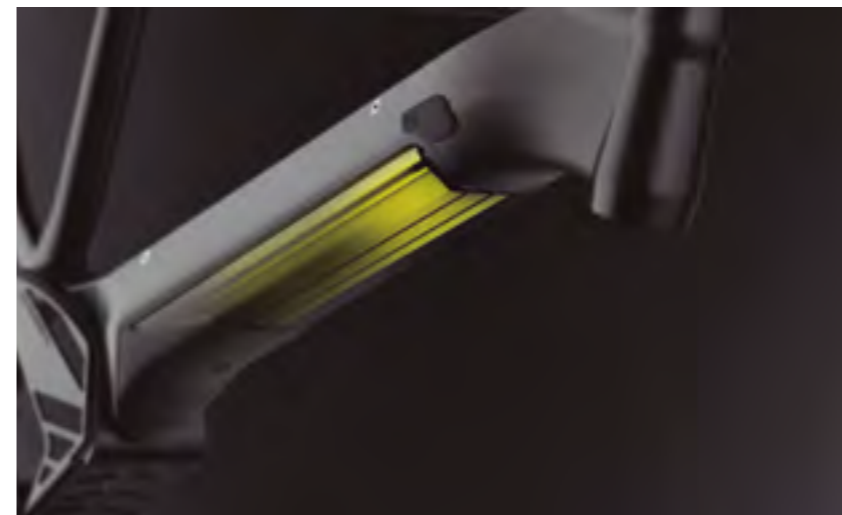



## FRAME FEATURES

- / Hydroformed AL7000 frame is light and strong with sophisticated shaping that places material where it's needed.
- / 27+ and 29 compatible.
- / BOOST 148 Spacing.
- / Metal armor skid plate protects the motor for long life.

## EMTB COMPONENTS

- / 35mm stems and wide handlebars.
- / Suspension is optimized for eMTB use.
- / Stronger wheels and larger brake rotors.
- / Tires with reinforced eMTB casing.
- / More comfortable saddles.
- / eMTB geometry with short chainstays and an upright trail bike position.



# WILD FS

SIZES	S	M	L	XL
1 - Seat Tube (C-T)	390	430	470	510
2 - Top Tube (EFF)	565	581	610	639
3 - Head Tube	115	128	143	159
4 - Chainstay	450	450	450	450
5 - BB Height	337,5	337,5	337,5	337,5
6 - BB Drop	30	30	30	30
7 - Wheelbase	1132	1152	1183	1215
8 - Head Angle	67	67	67	67
9 - Seat Angle	74°	74°	74°	74°
10 - Standover	715	745	765	790
11 - Reach	385	400	425	450
12 - Stack	620	632	646	661
13 - Fork Length	545 [FORK 140MM]	545 [FORK 140MM]	545 [FORK 140MM]	545 [FORK 140MM]

HEIGHT (cm)	HEIGHT (in)	SIZE
<165	<65.0"	S
165-175	65.0"-68.9"	M
175-185	68.9"-72.8"	L
>185	>72.8"	XL

 Bright Red-Black (Matt-Gloss) W8
  Purple-Black (Matt) W9

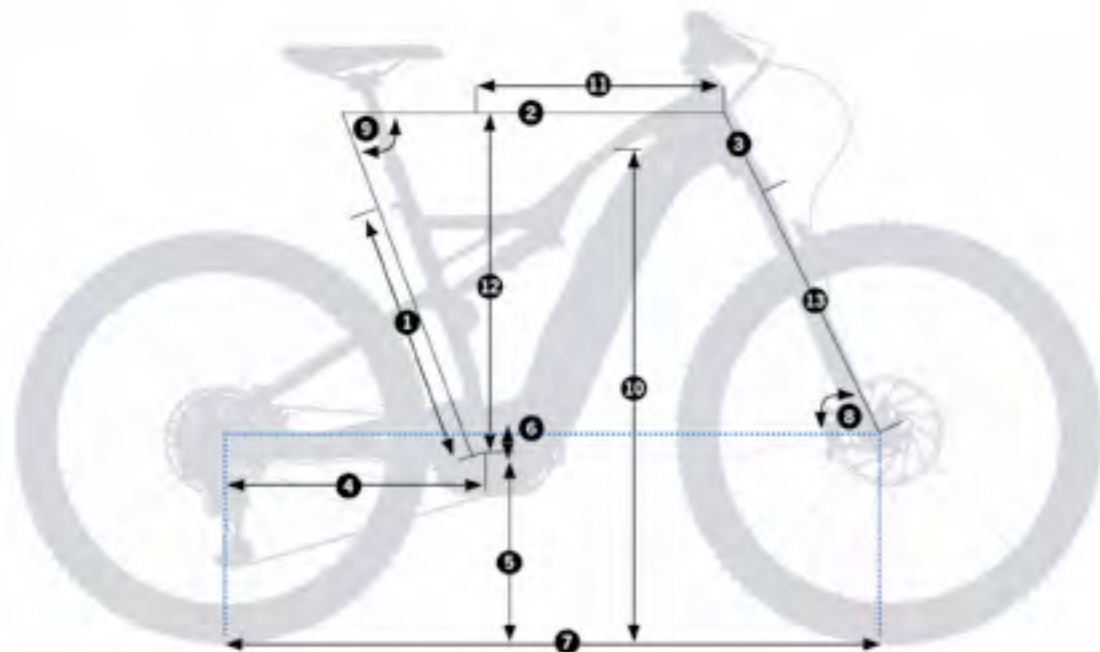

# WILD FS 150 10 29S *MyO.com*

Code	J339		
Size	Crank	Stem	Handlebar
S	152	50	780
M	152	50	780
L	152	50	780
XL	152	50	780



<b>Frame</b>	ORBEA WILD Full Suspension 2019 Hydro-formed Alloy 140mm Travel Boost 12X148 for Shimano E8000/7000
<b>Shock</b>	Fox Float DPS Factory 3-Position Adjust Evol Kashima custom tune 200x51mm
<b>Fork</b>	Fox 36 Float Factory 150 Grip2 RC2 QR15x110 Kashima
<b>Crankset</b>	SRAM X-SYNC Eagle 34T
<b>Crank</b>	Miranda Delta 152mm
<b>Headset</b>	ACROS 1-1/8 - 1-1/2" Integrated
<b>Handlebar</b>	Race Face Aeffect 35 20mm Rise 780mm
<b>Stem</b>	Race Face Aeffect 35mm interface
<b>Shifters</b>	SRAM XX1 Eagle Single click
<b>Brakes</b>	Avid Code RSC Hydraulic Disc
<b>Rear Derailleur</b>	SRAM XX1 Eagle Gold



<b>Chain</b>	SRAM XX1 Eagle 12-Speed
<b>Wheels</b>	DT HX-1501 Spline 30c TLR 15/110mm IS (6-bolt)
<b>Cassette</b>	SRAM NX PG-1230 Eagle 11-50t 12-Speed
<b>Tyres</b>	Kenda 1211E Nevegal 29x2,6" 60TPI TLR (E-MTB specific)
<b>Pedals</b>	VPE-537 Black
<b>Seatpost</b>	Race Face Aeffect Dropper 31.6x385/125mm Crank brothers Highline 31,6x425/150mm
<b>Saddle</b>	Selle Royal 2077 DRN
<b>Lock</b>	Abus battery down tube lock
<b>Chainguide</b>	Etherteen E8000
<b>Motor</b>	Shimano DU-E8000 25kmh
<b>Battery</b>	Shimano Steps E8010 500Wh

<b>Display</b>	Shimano Steps SC-E8000
<b>Remote 1</b>	Shimano E8000 switch unit for assist

# WILD FS 10 29S *MyO.com*

Code	J336		
Size	Crank	Stem	Handlebar
S	152	50	780
M	152	50	780
L	152	50	780
XL	152	50	780



<b>Frame</b>	ORBEA WILD Full Suspension 2019 Hydro-formed Alloy 140mm Travel Boost 12X148 for Shimano E8000/7000
<b>Shock</b>	Fox Float DPS Factory 3-Position Adjust Evol Kashima custom tune 200x51mm
<b>Fork</b>	Fox 34 Float Factory 140 FIT4 3-Pos-Adj QR15x110 Kashima E-Bike Optimized Fox 36 Float Factory 150 Grip2 RC2 QR15x110 Kashima
<b>Crankset</b>	SRAM X-SYNC Eagle 34T
<b>Crank</b>	Miranda Delta 152mm
<b>Headset</b>	ACROS 1-1/8 - 1-1/2" Integrated
<b>Handlebar</b>	Race Face Aeffect 35 20mm Rise 780mm
<b>Stem</b>	Race Face Aeffect 35mm interface
<b>Shifters</b>	SRAM XX1 Eagle Single click
<b>Brakes</b>	Sram Code RSC Hydraulic Disc



<b>Rear Derailleur</b>	SRAM XX1 Eagle Gold
<b>Chain</b>	SRAM XX1 Eagle 12-Speed
<b>Wheels</b>	DT H-1700 Spline 30c TLR 15/110mm IS (6-bolt)
<b>Cassette</b>	SRAM NX PG-1230 Eagle 11-50t 12-Speed
<b>Tyres</b>	Kenda 1184A Havok 29x2,4" 60TPI TLR (E-MTB specific) Kenda 1201E Hellkat/1211E Nevegal 29X2,6 60 TPI TLR (E-MTB)
<b>Pedals</b>	VPE-537 Black
<b>Seatpost</b>	Race Face Aeffect Dropper 31.6x385/125mm Crank brothers Highline 31,6x425/150mm
<b>Saddle</b>	Selle Royal 2077 DRN
<b>Lock</b>	Abus battery down tube lock

<b>Chainguide</b>	Etherteen E8000
<b>Motor</b>	Shimano DU-E8000 25kmh
<b>Battery</b>	Shimano Steps E8010 500Wh
<b>Display</b>	Shimano Steps SC-E8000
<b>Remote 1</b>	Shimano E8000 switch unit for assist



## WILD FS 150 20 29S *MyO.LSD*

Code	J338		
Size	Crank	Stem	Handlebar
S	152	50	760
M	152	50	760
L	152	50	760
XL	152	50	760



<b>Frame</b>	ORBEA WILD Full Suspension 2019 Hydroformed Alloy 140mm Travel Boost 12X148 for Shimano E8000/7000
<b>Shock</b>	Fox Float DPS Performance 3-Position Evol custom tune 200x51mm
<b>Fork</b>	Fox 36 Float Performance 150 Grip2 RC2 QR15x110
<b>Crankset</b>	Shimano E80 34t
<b>Crank</b>	Miranda Delta 152mm
<b>Headset</b>	ACROS 1-1/8 - 1-1/2" Integrated
<b>Handlebar</b>	Race Face Ride 35 20mm Rise 760mm
<b>Stem</b>	Race Face Ride 35mm interface
<b>Shifters</b>	Shimano XT M8000 I-Spec
<b>Brakes</b>	Shimano XT M8020 Hydraulic disc
<b>Rear Derailleur</b>	Shimano XT M8000 GS Shadow Plus Direct Mount

<b>Chain</b>	KMC e11 Turbo Silver
<b>Wheels</b>	DT H-1700 Spline 30c TLR 15/110mm IS (6-bolt)
<b>Cassette</b>	Sun Race 11-46t 11-Speed
<b>Tyres</b>	Kenda 1211E Nevegal 29x2,6" 60TPI TLR (E-MTB specific)
<b>Pedals</b>	VPE-537 Black
<b>Seatpost</b>	Race Face Aeffect Dropper 31.6x385/125mm
	Crank brothers Highline 31,6x425/150mm
<b>Saddle</b>	Selle Royal 2077 DRN
<b>Lock</b>	Abus battery down tube lock
<b>Chainguide</b>	Etherteen E8000
<b>Motor</b>	Shimano DU-E8000 25kmh
<b>Battery</b>	Shimano Steps E8010 500Wh

<b>Display</b>	Shimano Steps SC-E8000
<b>Remote 1</b>	Shimano E8000 switch unit for assist

## WILD FS 20 29S *MyO.LSD*

Code	J334		
Size	Crank	Stem	Handlebar
S	152	50	760
M	152	50	760
L	152	50	760
XL	152	50	760



<b>Frame</b>	ORBEA WILD Full Suspension 2019 Hydroformed Alloy 140mm Travel Boost 12X148 for Shimano E8000/7000
<b>Shock</b>	Fox Float DPS Performance 3-Position Evol custom tune 200x51mm
<b>Fork</b>	Fox 34 Float Performance 140 3-Position QR15x110 E-Bike Optimized Fox 36 Float Performance 150 Grip2 RC2 QR15x110
<b>Crankset</b>	Shimano E80 34t
<b>Crank</b>	Miranda Delta 152mm
<b>Headset</b>	ACROS 1-1/8 - 1-1/2" Integrated
<b>Handlebar</b>	Race Face Ride 35 20mm Rise 760mm
<b>Stem</b>	Race Face Ride 35mm interface
<b>Shifters</b>	Shimano XT M8000 I-Spec
<b>Brakes</b>	Shimano XT M8020 Hydraulic disc

<b>Rear Derailleur</b>	Shimano XT M8000 GS Shadow Plus Direct Mount
<b>Chain</b>	KMC e11 Turbo Silver
<b>Wheels</b>	DT H-1900 Spline 30c TLR 15/110mm IS (6-bolt) DT H-1700 Spline 30c TLR 15/110mm IS (6-bolt)
<b>Cassette</b>	Sun Race 11-46t 11-Speed
<b>Tyres</b>	Kenda 1184A Havok 29x2,4" 60TPI TLR (E-MTB specific) Kenda 1201E Hellkat/1211E Nevegal 29X2,6 60 TPI TLR (E-MTB)
<b>Pedals</b>	VPE-537 Black
<b>Seatpost</b>	Race Face Aeffect Dropper 31.6x385/125mm Crank brothers Highline 31,6x425/150mm

<b>Saddle</b>	Selle Royal 2077 DRN
<b>Lock</b>	Abus battery down tube lock
<b>Chainguide</b>	Etherteen E8000
<b>Motor</b>	Shimano DU-E8000 25kmh
<b>Battery</b>	Shimano Steps E8010 500Wh
<b>Display</b>	Shimano Steps SC-E8000
<b>Remote 1</b>	Shimano E8000 switch unit for assist

## WILD FS 30 29S *MyO.LSD*

Code	J332		
Size	Crank	Stem	Handlebar
S	152	55	780
M	152	55	780
L	152	55	780
XL	152	55	780



<b>Frame</b>	ORBEA WILD Full Suspension 2019 Hydroformed Alloy 140mm Travel Boost 12X148 for Shimano E8000/7000
<b>Shock</b>	Fox Float DPS Performance 3-Position Evol custom tune 200x51mm
<b>Fork</b>	Fox 34 Float Performance 140 3-Position QR15x110 E-Bike Optimized Fox 36 Float Performance 150 Grip2 RC2 QR15x110
<b>Crankset</b>	SRAM X-SYNC Eagle 34T
<b>Crank</b>	Miranda Delta 152mm
<b>Headset</b>	ACROS 1-1/8 - 1-1/2" Integrated
<b>Handlebar</b>	Orbea 35mm Riser 780mm
<b>Stem</b>	Orbea 35mm interface
<b>Shifters</b>	SRAM NX Eagle Single click
<b>Brakes</b>	SRAM Guide Hydraulic disc

	Sram Code RSC Hydraulic Disc
<b>Rear Derailleur</b>	SRAM NX Eagle
<b>Chain</b>	SRAM NX Eagle 12-Speed
<b>Wheels</b>	DT H-1900 Spline 30c TLR 15/110mm IS (6-bolt) DT H-1700 Spline 30c TLR 15/110mm IS (6-bolt)
<b>Cassette</b>	SRAM NX PG-1230 Eagle 11-50t 12-Speed
<b>Tyres</b>	Kenda 1184A Havok 29x2,4" 60TPI TLR (E-MTB specific) Kenda 1201E Hellkat/1211E Nevegal 29X2,6 60 TPI TLR (E-MTB)
<b>Pedals</b>	VPE-537 Black
<b>Seatpost</b>	Race Face Aeffect Dropper 31.6x385/125mm Crank brothers Highline 31,6x425/150mm

<b>Saddle</b>	Selle Royal 2077 DRN
<b>Lock</b>	Abus battery down tube lock
<b>Chainguide</b>	Orbea OC chainguide
<b>Motor</b>	Shimano DU-E8000 25kmh
<b>Battery</b>	Shimano Steps E8010 500Wh
<b>Display</b>	Shimano Steps SC-E7000
<b>Remote 1</b>	Shimano E8000 switch unit for assist

## WILD FS 40 29S *MyO.LSD*

Code	J330		
Size	Crank	Stem	Handlebar
S	152	55	780
M	152	55	780
L	152	55	780
XL	152	55	780



<b>Frame</b>	ORBEA WILD Full Suspension 2019 Hydroformed Alloy 140mm Travel Boost 12X148 for Shimano E8000/7000
<b>Shock</b>	Fox Float DPS Performance 3-Position Evol custom tune 200x51mm
<b>Fork</b>	Rock Shox Sektor RL 140 Air QR15x110 Boost e-MTB Fox 34 Float Performance 140 3-Position QR15x110 E-Bike
<b>Crankset</b>	Shimano E80 34t
<b>Crank</b>	Miranda Delta 152mm
<b>Headset</b>	ACROS 1-1/8 - 1-1/2" Integrated
<b>Handlebar</b>	Orbea 35mm Riser 780mm
<b>Stem</b>	Orbea 35mm interface
<b>Shifters</b>	Shimano Deore M6000
<b>Brakes</b>	Shimano MT201 Hydraulic Disc

	Shimano XT M8020 Hydraulic disc
<b>Rear Derailleur</b>	Shimano Deore M6000 GS Shadow Plus Direct Mount Shimano SLX M7000 11-46t
<b>Chain</b>	KMC e10 Turbo Silver
<b>Wheels</b>	Duroc 35 TL 6-Bolt DT H-1700 Spline 30c TLR 15/110mm IS (6-bolt)
<b>Cassette</b>	Sun Race 11-42t 10-Speed
<b>Tyres</b>	Kenda 1184A Havok 29x2,4" 60TPI TLR (E-MTB specific) Kenda 1201E Hellkat/1211E Nevegal 29X2,6 60 TPI TLR (E-MTB)
<b>Pedals</b>	VPE-537 Black
<b>Seatpost</b>	Race Face Aeffect Dropper 31.6x385/125mm

	Crank brothers Highline 31,6x425/150mm
<b>Saddle</b>	Selle Royal 2077 DRN
<b>Lock</b>	Abus battery down tube lock
<b>Chainguide</b>	Orbea OC chainguide
<b>Motor</b>	Shimano DU-E7000 25kmh Shimano Steps E8000 System
<b>Battery</b>	Shimano Steps E8010 500Wh
<b>Display</b>	Shimano Steps SC-E7000
<b>Remote1</b>	Shimano E7000 switch unit for assist

## WILD FS 10 27S

MyO<sub>2.0</sub>

Code	J337		
Size	Crank	Stem	Handlebar
S	152	50	780
M	152	50	780
L	152	50	780
XL	152	50	780



<b>Frame</b>	ORBEA WILD Full Suspension 2019 Hydro-formed Alloy 140mm Travel Boost 12X148 for Shimano E8000/7000
<b>Shock</b>	Fox Float DPS Factory 3-Position Adjust Evol Kashima custom tune 200x51mm
<b>Fork</b>	Fox 34 Float Factory 140 FIT4 3-Pos-Adj QR15x110 Kashima E-Bike Optimized Fox 36 Float Factory 150 Grip2 RC2 QR15x110 Kashima
<b>Crankset</b>	SRAM X-SYNC Eagle 34T
<b>Crank</b>	Miranda Delta 152mm
<b>Headset</b>	ACROS 1-1/8 - 1-1/2" Integrated
<b>Handlebar</b>	Race Face Aeffect 35 20mm Rise 780mm
<b>Stem</b>	Race Face Aeffect 35mm interface
<b>Shifters</b>	SRAM XX1 Eagle Single click
<b>Brakes</b>	Sram Code RSC Hydraulic Disc

<b>Rear Derailleur</b>	SRAM XX1 Eagle Gold
<b>Chain</b>	SRAM XX1 Eagle 12-Speed
<b>Wheels</b>	DT H-1700 Spline 35c TLR 15/110mm IS (6-bolt)
<b>Cassette</b>	SRAM NX PG-1230 Eagle 11-50t 12-Speed
<b>Tyres</b>	Kenda 1184A Havok 27,5x2,8" 120TPI TLR (E-MTB specific)
<b>Pedals</b>	VPE-537 Black
<b>Seatpost</b>	Race Face Aeffect Dropper 31.6x385/125mm Crank brothers Highline 31,6x425/150mm
<b>Saddle</b>	Selle Royal 2077 DRN
<b>Lock</b>	Abus battery down tube lock
<b>Chainguide</b>	Etherteen E8000
<b>Motor</b>	Shimano DU-E8000 25kmh

<b>Battery</b>	Shimano Steps E8010 500Wh
<b>Display</b>	Shimano Steps SC-E8000
<b>Remote 1</b>	Shimano E8000 switch unit for assist

## WILD FS 20 27S

MyO<sub>2.0</sub>

Code	J335		
Size	Crank	Stem	Handlebar
S	152	50	760
M	152	50	760
L	152	50	760
XL	152	50	760



<b>Frame</b>	ORBEA WILD Full Suspension 2019 Hydro-formed Alloy 140mm Travel Boost 12X148 for Shimano E8000/7000
<b>Shock</b>	Fox Float DPS Performance 3-Position Evol custom tune 200x51mm
<b>Fork</b>	Fox 34 Float Performance 140 3-Position QR15x110 E-Bike Optimized Fox 36 Float Performance 150 Grip2 RC2 QR15x110
<b>Crankset</b>	Shimano E80 34t
<b>Crank</b>	Miranda Delta 152mm
<b>Headset</b>	ACROS 1-1/8 - 1-1/2" Integrated
<b>Handlebar</b>	Race Face Ride 35 20mm Rise 760mm
<b>Stem</b>	Race Face Ride 35mm interface
<b>Shifters</b>	Shimano XT M8000 I-Spec
<b>Brakes</b>	Shimano XT M8020 Hydraulic disc

<b>Rear Derailleur</b>	Shimano XT M8000 GS Shadow Plus Direct Mount
<b>Chain</b>	KMC e11 Turbo Silver
<b>Wheels</b>	DT H-1900 Spline 35c TLR 15/110mm IS (6-bolt) DT H-1700 Spline 30c TLR 15/110mm IS (6-bolt)
<b>Cassette</b>	Sun Race 11-46t 11-Speed
<b>Tyres</b>	Kenda 1184A Havok 27,5x2,8" 120TPI TLR (E-MTB specific)
<b>Pedals</b>	VPE-537 Black
<b>Seatpost</b>	Race Face Aeffect Dropper 31.6x385/125mm Crank brothers Highline 31,6x425/150mm
<b>Saddle</b>	Selle Royal 2077 DRN
<b>Lock</b>	Abus battery down tube lock

<b>Chainguide</b>	Etherteen E8000
<b>Motor</b>	Shimano DU-E8000 25kmh
<b>Battery</b>	Shimano Steps E8010 500Wh
<b>Display</b>	Shimano Steps SC-E8000
<b>Remote 1</b>	Shimano E8000 switch unit for assist

## WILD FS 30 27S

MyO<sub>2.0</sub>

Code	J333		
Size	Crank	Stem	Handlebar
S	152	55	780
M	152	55	780
L	152	55	780
XL	152	55	780



<b>Frame</b>	ORBEA WILD Full Suspension 2019 Hydro-formed Alloy 140mm Travel Boost 12X148 for Shimano E8000/7000
<b>Shock</b>	Fox Float DPS Performance 3-Position Evol custom tune 200x51mm
<b>Fork</b>	Fox 34 Float Performance 140 3-Position QR15x110 E-Bike Optimized Fox 36 Float Performance 150 Grip2 RC2 QR15x110
<b>Crankset</b>	SRAM X-SYNC Eagle 34T
<b>Crank</b>	Miranda Delta 152mm
<b>Headset</b>	ACROS 1-1/8 - 1-1/2" Integrated
<b>Handlebar</b>	Orbea 35mm Riser 780mm
<b>Stem</b>	Orbea 35mm interface
<b>Shifters</b>	SRAM NX Eagle Single click
<b>Brakes</b>	SRAM Guide Hydraulic disc

	Sram Code RSC Hydraulic Disc
<b>Rear Derailleur</b>	SRAM NX Eagle
<b>Chain</b>	SRAM NX Eagle 12-Speed
<b>Wheels</b>	DT H-1900 Spline 35c TLR 15/110mm IS (6-bolt) DT H-1700 Spline 30c TLR 15/110mm IS (6-bolt)
<b>Cassette</b>	SRAM NX PG-1230 Eagle 11-50t 12-Speed
<b>Tyres</b>	Kenda 1184A Havok 27,5x2,8" 120TPI TLR (E-MTB specific)
<b>Pedals</b>	VPE-537 Black
<b>Seatpost</b>	Race Face Aeffect Dropper 31.6x385/125mm Crank brothers Highline 31,6x425/150mm
<b>Saddle</b>	Selle Royal 2077 DRN

<b>Lock</b>	Abus battery down tube lock
<b>Chainguide</b>	Orbea OC chainguide
<b>Motor</b>	Shimano DU-E8000 25kmh
<b>Battery</b>	Shimano Steps E8010 500Wh
<b>Display</b>	Shimano Steps SC-E7000
<b>Remote 1</b>	Shimano E8000 switch unit for assist

## WILD FS 40 27S

MyO<sub>2.0</sub>

Code	J331		
Size	Crank	Stem	Handlebar
S	152	55	780
M	152	55	780
L	152	55	780
XL	152	55	780



<b>Frame</b>	ORBEA WILD Full Suspension 2019 Hydro-formed Alloy 140mm Travel Boost 12X148 for Shimano E8000/7000
<b>Shock</b>	Fox Float DPS Performance 3-Position Evol custom tune 200x51mm
<b>Fork</b>	Rock Shox Sektor RL 140 Air QR15x110 Boost e-MTB Fox 34 Float Performance 140 3-Position QR15x110 E-Bike
<b>Crankset</b>	Shimano E80 34t
<b>Crank</b>	Miranda Delta 152mm
<b>Headset</b>	ACROS 1-1/8 - 1-1/2" Integrated
<b>Handlebar</b>	Orbea 35mm Riser 780mm
<b>Stem</b>	Orbea 35mm interface
<b>Shifters</b>	Shimano Deore M6000
<b>Brakes</b>	Shimano MT201 Hydraulic Disc

	Shimano XT M8020 Hydraulic disc
<b>Rear Derailleur</b>	Shimano Deore M6000 GS Shadow Plus Direct Mount Shimano SLX M7000 11-46t
<b>Chain</b>	KMC e10 Turbo Silver
<b>Wheels</b>	Duroc 40 TL 6-Bolt DT H-1700 Spline 30c TLR 15/110mm IS (6-bolt)
<b>Cassette</b>	Sun Race 11-42t 10-Speed
<b>Tyres</b>	Kenda 1184A Havok 27,5x2,8" 120TPI TLR (E-MTB specific)
<b>Pedals</b>	VPE-537 Black
<b>Seatpost</b>	Race Face Aeffect Dropper 31.6x385/125mm Crank brothers Highline 31,6x425/150mm

<b>Saddle</b>	Selle Royal 2077 DRN
<b>Lock</b>	Abus battery down tube lock
<b>Chainguide</b>	Orbea OC chainguide
<b>Motor</b>	Shimano DU-E7000 25kmh Shimano Steps E8000 System
<b>Battery</b>	Shimano Steps E8010 500Wh
<b>Display</b>	Shimano Steps SC-E7000
<b>Remote 1</b>	Shimano E7000 switch unit for assist



## WILD HT-SHIMANO

SIZES	S	M	L	XL
1 - Seat Tube (C-T)	390	390	415	440
2 - Top Tube (EFF)	575	595	624	653
3 - Head Tube	115	130	145	160
4 - Chainstay	445	445	445	445
6 - BB Drop	63	63	63	63
7 - Wheelbase	1113	1134	1165	1195
8 - Head Angle	67°	67°	67°	67°
9 - Seat Angle	72.5°	72.5°	72.5°	72.5°
10 - Standover	798	805	816	826
11 - Reach	375	390	415	440
12 - Stack	364	647	661	675
13 - Fork Length	527 [FORK 120MM]	527 [FORK 120MM]	527 [FORK 120MM]	527 [FORK 120MM]

HEIGHT (cm)	HEIGHT (in)	SIZE
<165	<65.0"	S
165-175	65.0"-68.9"	M
175-185	68.9"-72.8"	L
>185	>72.8"	XL

 Bright Red-Black (Gloss) WR

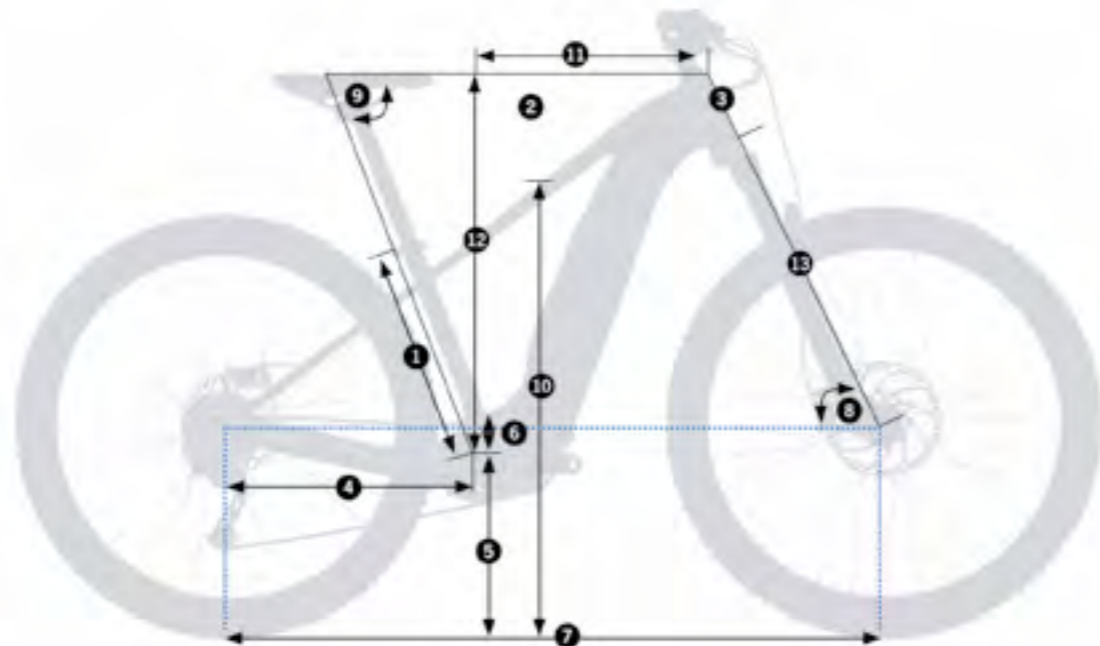

## WILD HT 20 29S

Code	J328		
Size	Crank	Stem	Handlebar
S	152	50	760
M	152	50	760
L	152	50	760
XL	152	50	760



<b>Frame</b>	ORBEA Wild 2019 Alloy 12X148 Hydroformed Alloy 140mm Travel Boost 12X148 for Shimano E8000/7000
<b>Fork</b>	Fox 34 Float Performance 120 3-Position QR15x110 E-Bike Optimized Fox 34 Float Factory 120 FIT4 3-Pos-Adj QR15x110 Kashima
<b>Crankset</b>	SRAM X-SYNC Eagle 34T
<b>Crank</b>	Miranda Delta 152mm
<b>Headset</b>	ACROS 1-1/8 - 1-1/2" Integrated
<b>Handlebar</b>	Race Face Ride 35 20mm Rise 760mm
<b>Stem</b>	Race Face Ride 35mm interface
<b>Shifters</b>	SRAM NX Eagle Single click
<b>Brakes</b>	SRAM Guide Hydraulic disc Sram Code RSC Hydraulic Disc



<b>Rear Derailleur</b>	SRAM NX Eagle
<b>Chain</b>	SRAM NX Eagle 12-Speed
<b>Wheels</b>	DT H-1900 Spline 30c TLR 15/110mm IS (6-bolt) DT H-1700 Spline 30c TLR 15/110mm IS (6-bolt)
<b>Cassette</b>	SRAM NX PG-1230 Eagle 11-50t 12-Speed
<b>Tyres</b>	Kenda 1184A Havok 29x2,4" 60TPI TLR (E-MTB specific) Kenda 1201E Hellkat/1211E Nevegal 29X2,6 60 TPI TLR (E-MTB)
<b>Pedals</b>	VPE-537 Black
<b>Seatpost</b>	Race Face Affect Dropper 31.6x385/125mm Crank brothers Highline 31,6x425/150mm
<b>Saddle</b>	Selle Royal 2077 DRN

<b>Lock</b>	Abus battery down tube lock
<b>Chainguide</b>	Orbea OC chainguide
<b>Motor</b>	Shimano DU-E8000 25kmh
<b>Battery</b>	Shimano Steps E8010 500Wh
<b>Display</b>	Shimano Steps SC-E8000
<b>Remote 1</b>	Shimano E8000 switch unit for assist

## WILD HT 40 29S

Code	J326		
Size	Crank	Stem	Handlebar
S	152	55	780
M	152	55	780
L	152	55	780
XL	152	55	780



<b>Frame</b>	ORBEA Wild 2019 Alloy 12X148 Hydroformed Alloy 140mm Travel Boost 12X148 for Shimano E8000/7000
<b>Fork</b>	RockShox Recon RL 120 Air Remote Q15x110 e-MTB Fox 34 Float Performance 120 3-Pos QR15x110 E-Bike Optimized
<b>Crankset</b>	Shimano E80 34t
<b>Crank</b>	Miranda Delta 152mm
<b>Headset</b>	ACROS 1-1/8 - 1-1/2" Integrated
<b>Handlebar</b>	Orbea 35mm Riser 780mm
<b>Stem</b>	Orbea 35mm interface
<b>Shifters</b>	Shimano Deore M6000
<b>Brakes</b>	Shimano MT201 Hydraulic Disc Shimano XT M8020 Hydraulic disc

<b>Rear Derailleur</b>	Shimano Deore M6000 GS Shadow Plus Direct Mount Shimano SLX M7000 11-46t
<b>Chain</b>	KMC e10 Turbo Silver
<b>Wheels</b>	Orbea Tryp 30c Disc Tubeless ready DT H-1700 Spline 30c TLR 15/110mm IS (6-bolt)
<b>Cassette</b>	Sun Race 11-42t 10-Speed
<b>Tyres</b>	Kenda 1184A Havok 29x2,4" 60TPI TLR (E-MTB specific) Kenda 1201E Hellkat/1211E Nevegal 29X2,6 60 TPI TLR (E-MTB)
<b>Pedals</b>	VPE-537 Black
<b>Seatpost</b>	Orbea OC-I 31.6x400mm Crank brothers Highline 31,6x425/150mm

<b>Saddle</b>	Selle Royal 2077 DRN
<b>Lock</b>	Abus battery down tube lock
<b>Chainguide</b>	Orbea OC chainguide
<b>Motor</b>	Shimano DU-E7000 25kmh Shimano Steps E8000 System
<b>Battery</b>	Shimano Steps E8010 500Wh
<b>Display</b>	Shimano Steps SC-E7000
<b>Remote 1</b>	Shimano E7000 switch unit for assist



## WILD HT 20 27S

MyO<sub>2</sub>

Code	J329		
Size	Crank	Stem	Handlebar
S	152	50	760
M	152	50	760
L	152	50	760
XL	152	50	760



<b>Frame</b>	ORBEA Wild 2019 Alloy 12X148 Hydroformed Alloy 140mm Travel Boost 12X148 for Shimano E8000/7000
<b>Fork</b>	Fox 34 Float Performance 120 3-Position QR15x110 E-Bike Optimized Fox 34 Float Factory 120 FIT4 3-Pos-Adj QR15x110 Kashima
<b>Crankset</b>	SRAM X-SYNC Eagle 34T
<b>Crank</b>	Miranda Delta 152mm
<b>Headset</b>	ACROS 1-1/8 - 1-1/2" Integrated
<b>Handlebar</b>	Race Face Ride 35 20mm Rise 760mm
<b>Stem</b>	Race Face Ride 35mm interface
<b>Shifters</b>	SRAM NX Eagle Single click
<b>Brakes</b>	SRAM Guide Hydraulic disc Sram Code RSC Hydraulic Disc

<b>Rear Derailleur</b>	SRAM NX Eagle
<b>Chain</b>	SRAM NX Eagle 12-Speed
<b>Wheels</b>	DT H-1900 Spline 35c TLR 15/110mm IS (6-bolt) DT H-1700 Spline 30c TLR 15/110mm IS (6-bolt)
<b>Cassette</b>	SRAM NX PG-1230 Eagle 11-50t 12-Speed
<b>Tyres</b>	Kenda 1184A Havok 27,5x2,8" 120TPI TLR (E-MTB specific)
<b>Pedals</b>	VPE-537 Black
<b>Seatpost</b>	Race Face Affect Dropper 31.6x385/125mm
	Crank brothers Highline 31,6x425/150mm
<b>Saddle</b>	Selle Royal 2077 DRN
<b>Lock</b>	Abus battery down tube lock

<b>Chainguide</b>	Orbea OC chainguide
<b>Motor</b>	Shimano DU-E8000 25kmh
<b>Battery</b>	Shimano Steps E8010 500Wh
<b>Display</b>	Shimano Steps SC-E8000
<b>Remote 1</b>	Shimano E8000 switch unit for assist

## WILD HT 40 27S

MyO<sub>2</sub>

Code	J327		
Size	Crank	Stem	Handlebar
S	152	55	780
M	152	55	780
L	152	55	780
XL	152	55	780



<b>Frame</b>	ORBEA Wild 2019 Alloy 12X148 Hydroformed Alloy 140mm Travel Boost 12X148 for Shimano E8000/7000
<b>Fork</b>	RockShox Recon RL 120 Air Remote Q15x110 e-MTB Fox 34 Float Performance 120 3-Pos QR15x110 E-Bike Optimized
<b>Crankset</b>	Shimano E80 34t
<b>Crank</b>	Miranda Delta 152mm
<b>Headset</b>	ACROS 1-1/8 - 1-1/2" Integrated
<b>Handlebar</b>	Orbea 35mm Riser 780mm
<b>Stem</b>	Orbea 35mm interface
<b>Shifters</b>	Shimano Deore M6000
<b>Brakes</b>	Shimano MT201 Hydraulic Disc Shimano XT M8020 Hydraulic disc

<b>Rear Derailleur</b>	Shimano Deore M6000 GS Shadow Plus Direct Mount Shimano SLX M7000 11-46t
<b>Chain</b>	KMC e10 Turbo Silver
<b>Wheels</b>	Orbea Tryp 35c Disc Tubeless ready DT H-1700 Spline 30c TLR 15/110mm IS (6-bolt)
<b>Cassette</b>	Sun Race 11-42t 10-Speed
<b>Tyres</b>	Kenda 1184A Havok 27,5x2,8" 120TPI TLR (E-MTB specific)
<b>Pedals</b>	VPE-537 Black
<b>Seatpost</b>	Orbea OC-I 31.6x400mm Crank brothers Highline 31,6x425/150mm
<b>Saddle</b>	Selle Royal 2077 DRN
<b>Lock</b>	Abus battery down tube lock

<b>Chainguide</b>	Orbea OC chainguide
<b>Motor</b>	Shimano DU-E7000 25kmh Shimano Steps E8000 System
<b>Battery</b>	Shimano Steps E8010 500Wh
<b>Display</b>	Shimano Steps SC-E7000
<b>Remote 1</b>	Shimano E7000 switch unit for assist

## WILD HT-BOSCH

SIZES	S	M	L	XL
1 - Seat Tube (C-T)	390	390	415	440
2 - Top Tube (EFF)	575	595	624	653
3 - Head Tube	115	130	145	160
4 - Chainstay	470	470	470	470
6 - BB Drop	63	63	63	63
7 - Wheelbase	1139	1160	1190	1221
8 - Head Angle	67°	67°	67°	67°
9 - Seat Angle	72.5°	72.5°	72.5°	72.5°
10 - Standover	798	805	816	826
11 - Reach	375	390	415	440
12 - Stack	364	647	661	675
13 - Fork Length	527 [FORK 120MM]	527 [FORK 120MM]	527 [FORK 120MM]	527 [FORK 120MM]

HEIGHT (cm)	HEIGHT (in)	SIZE
<165	<65.0"	S
165-175	65.0"-68.9"	M
175-185	68.9"-72.8"	L
>185	>72.8"	XL

- Black (Matt-Gloss) WK
- Purple-Black (Matt) WM
- Blue-Grey (Gloss) WN
- Red-Black (Gloss-Matt) WO

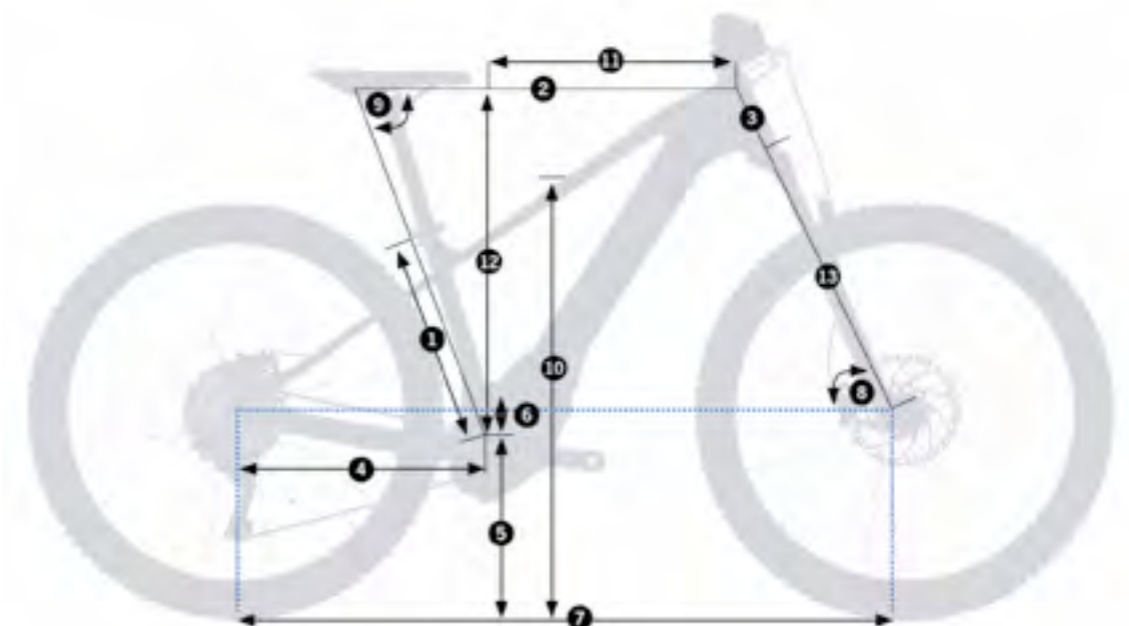

## WILD HT 10 29

MyO<sub>2</sub>

Code	J324		
Size	Crank	Stem	Handlebar
S	152	50	780
M	152	50	780
L	152	50	780
XL	152	50	780



<b>Frame</b>	ORBEA WILD 2018 Alloy 12X148 for Bosch
<b>Fork</b>	Fox 34 Float Factory 120 FIT4 3-Pos-Adj QR15x110 Kashima E-Bike Optimized
<b>Crankset</b>	FSA Bosch E-bike 14t Boost
<b>Crank</b>	Miranda Delta 152mm
<b>Headset</b>	ACROS 1-1/8 - 1-1/2" Integrated
<b>Handlebar</b>	Race Face Aeffect 35 20mm Rise 780mm
<b>Stem</b>	Race Face Aeffect 35mm interface
<b>Shifters</b>	SRAM XX1 Eagle Single click
<b>Brakes</b>	Avid Guide RE Hydraulic Disc
	Sram Code RSC Hydraulic Disc
<b>Rear Derailleur</b>	SRAM XX1 Eagle Gold
<b>Chain</b>	SRAM XX1 Eagle 12-Speed
<b>Wheels</b>	DT H-1700 Spline 30c TLR 15/110mm IS (6-bolt)

<b>Cassette</b>	SRAM NX PG-1230 Eagle 11-50t 12-Speed
<b>Tyres</b>	Kenda 1184A Havok 29x2,4" 60TPI TLR (E-MTB specific)
	Kenda 1201E Hellkat/1211E Nevegal 29X2,6 60 TPI TLR (E-MTB)
<b>Pedals</b>	VPE-537 Black
<b>Seatpost</b>	Race Face Aeffect Dropper 31.6x385/125mm
	Crank brothers Highline 31,6x425/150mm
<b>Saddle</b>	Selle Royal 2077 DRN
<b>Lock</b>	Abus battery power tube lock
<b>Motor</b>	BOSCH Performance CX 25 kmh
<b>Battery</b>	BOSCH Performance 500Wh
<b>Display</b>	BOSCH Performance Purion

## WILD HT 20 29

MyO<sub>2</sub>

Code	J322		
Size	Crank	Stem	Handlebar
S	152	50	760
M	152	50	760
L	152	50	760
XL	152	50	760



<b>Frame</b>	ORBEA WILD 2018 Alloy 12X148 for Bosch
<b>Fork</b>	Fox 34 Float Performance 120 3-Position QR15x110 E-Bike Optimized
	Fox 34 Float Factory 120 FIT4 3-Pos-Adj QR15x110 Kashima
<b>Crankset</b>	FSA Bosch E-bike 14t Boost
<b>Crank</b>	Miranda Delta 152mm
<b>Headset</b>	ACROS 1-1/8 - 1-1/2" Integrated
<b>Handlebar</b>	Race Face Ride 35 20mm Rise 760mm
<b>Stem</b>	Race Face Ride 35mm interface
<b>Shifters</b>	SRAM NX Eagle Single click
<b>Brakes</b>	SRAM Guide Hydraulic disc
	Sram Code RSC Hydraulic Disc
<b>Rear Derailleur</b>	SRAM NX Eagle
<b>Chain</b>	SRAM NX Eagle 12-Speed

<b>Wheels</b>	DT H-1900 Spline 30c TLR 15/110mm IS (6-bolt)
	DT H-1700 Spline 30c TLR 15/110mm IS (6-bolt)
<b>Cassette</b>	SRAM NX PG-1230 Eagle 11-50t 12-Speed
<b>Tyres</b>	Kenda 1184A Havok 29x2,4" 60TPI TLR (E-MTB specific)
	Kenda 1201E Hellkat/1211E Nevegal 29X2,6 60 TPI TLR (E-MTB)
<b>Pedals</b>	VPE-537 Black
<b>Seatpost</b>	Race Face Aeffect Dropper 31.6x385/125mm
	Crank brothers Highline 31,6x425/150mm
<b>Saddle</b>	Selle Royal 2077 DRN
<b>Lock</b>	Abus battery power tube lock
<b>Motor</b>	BOSCH Performance CX 25 kmh

<b>Battery</b>	BOSCH Performance 500Wh
<b>Display</b>	BOSCH Performance Purion

## WILD HT 30 29

MyO<sub>2</sub>

Code	J320		
Size	Crank	Stem	Handlebar
S	152	55	780
M	152	55	780
L	152	55	780
XL	152	55	780



<b>Frame</b>	ORBEA WILD 2018 Alloy 12X148 for Bosch
<b>Fork</b>	RockShox Recon RL 120 Air Remote Q15x110 e-MTB
	Fox 34 Float Performance 120 3-Pos QR15x110 E-Bike Optimized
<b>Crankset</b>	FSA Bosch E-bike 14t Boost
<b>Crank</b>	Miranda Delta 152mm
<b>Headset</b>	ACROS 1-1/8 - 1-1/2" Integrated
<b>Handlebar</b>	Orbea 35mm Riser 780mm
<b>Stem</b>	Orbea 35mm interface
<b>Shifters</b>	Shimano Deore M6000
<b>Brakes</b>	Shimano MT201 Hydraulic Disc
	Shimano XT M8020 Hydraulic disc
<b>Rear Derailleur</b>	Shimano Deore M6000 GS Shadow Plus Direct Mount

	Shimano SLX M7000 11-46t
<b>Chain</b>	KMC e10 Turbo Silver
<b>Wheels</b>	Orbea Tryp 30c Disc Tubeless ready
	DT H-1700 Spline 30c TLR 15/110mm IS (6-bolt)
<b>Cassette</b>	Sun Race 11-42t 10-Speed
<b>Tyres</b>	Kenda 1184A Havok 29x2,4" 60TPI TLR (E-MTB specific)
	Kenda 1201E Hellkat/1211E Nevegal 29X2,6 60 TPI TLR (E-MTB)
<b>Pedals</b>	VPE-537 Black
<b>Seatpost</b>	Race Face Aeffect Dropper 31.6x385/125mm
	Crank brothers Highline 31,6x425/150mm
<b>Saddle</b>	Selle Royal 2077 DRN

<b>Lock</b>	Abus battery power tube lock
<b>Motor</b>	BOSCH Performance CX 25 kmh
<b>Battery</b>	BOSCH Performance 500Wh
<b>Display</b>	BOSCH Performance Purion

## WILD HT 10 27

MyO<sub>2</sub>

Code	J325		
Size	Crank	Stem	Handlebar
S	152	50	780
M	152	50	780
L	152	50	780
XL	152	50	780



<b>Frame</b>	ORBEA WILD 2018 Alloy 12X148 for Bosch
<b>Fork</b>	Fox 34 Float Factory 120 FIT4 3-Pos-Adj QR15x110 Kashima E-Bike Optimized
<b>Crankset</b>	FSA Bosch E-bike 14t Boost
<b>Crank</b>	Miranda Delta 152mm
<b>Headset</b>	ACROS 1-1/8 - 1-1/2" Integrated
<b>Handlebar</b>	Race Face Aeffect 35 20mm Rise 780mm
<b>Stem</b>	Race Face Aeffect 35mm interface
<b>Shifters</b>	SRAM XX1 Eagle Single click
<b>Brakes</b>	Avid Guide RE Hydraulic Disc
	Sram Code RSC Hydraulic Disc
<b>Rear Derailleur</b>	SRAM XX1 Eagle Gold
<b>Chain</b>	SRAM XX1 Eagle 12-Speed
<b>Wheels</b>	DT H-1700 Spline 35c TLR 15/110mm IS (6-bolt)

<b>Cassette</b>	SRAM NX PG-1230 Eagle 11-50t 12-Speed
<b>Tyres</b>	Kenda 1184A Havok 27,5x2,8" 120TPI TLR (E-MTB specific)
<b>Pedals</b>	VPE-537 Black
<b>Seatpost</b>	Race Face Aeffect Dropper 31.6x385/125mm
	Crank brothers Highline 31,6x425/150mm
<b>Saddle</b>	Selle Royal 2077 DRN
<b>Lock</b>	Abus battery power tube lock
<b>Motor</b>	BOSCH Performance CX 25 kmh
<b>Battery</b>	BOSCH Performance 500Wh
<b>Display</b>	BOSCH Performance Purion

## WILD HT 20 27

Code	J323		
Size	Crank	Stem	Handlebar
S	152	50	760
M	152	50	760
L	152	50	760
XL	152	50	760



<b>Frame</b>	ORBEA WILD 2018 Alloy 12X148 for Bosch
<b>Fork</b>	Fox 34 Float Performance 120 3-Position QR15x110 E-Bike Optimized Fox 34 Float Factory 120 FIT4 3-Pos-Adj QR15x110 Kashima
<b>Crankset</b>	FSA Bosch E-bike 14t Boost
<b>Crank</b>	Miranda Delta 152mm
<b>Headset</b>	ACROS 1-1/8 - 1-1/2" Integrated
<b>Handlebar</b>	Race Face Ride 35 20mm Rise 760mm
<b>Stem</b>	Race Face Ride 35mm interface
<b>Shifters</b>	SRAM NX Eagle Single click
<b>Brakes</b>	SRAM Guide Hydraulic disc Sram Code RSC Hydraulic Disc
<b>Rear Derailleur</b>	SRAM NX Eagle
<b>Chain</b>	SRAM NX Eagle 12-Speed

<b>Wheels</b>	DT H-1900 Spline 35c TLR 15/110mm IS (6-bolt) DT H-1700 Spline 30c TLR 15/110mm IS (6-bolt)
<b>Cassette</b>	SRAM NX PG-1230 Eagle 11-50t 12-Speed
<b>Tyres</b>	Kenda 1184A Havok 27,5x2,8" 120TPI TLR (E-MTB specific)
<b>Pedals</b>	VPE-537 Black
<b>Seatpost</b>	Race Face Aeffect Dropper 31.6x385/125mm Crank brothers Highline 31,6x425/150mm
<b>Saddle</b>	Selle Royal 2077 DRN
<b>Lock</b>	Abus battery power tube lock
<b>Motor</b>	BOSCH Performance CX 25 kmh
<b>Battery</b>	BOSCH Performance 500Wh

<b>Display</b>	BOSCH Performance Purion
----------------	--------------------------

## WILD HT 30 27

Code	J321		
Size	Crank	Stem	Handlebar
S	152	55	780
M	152	55	780
L	152	55	780
XL	152	55	780



<b>Frame</b>	ORBEA WILD 2018 Alloy 12X148 for Bosch
<b>Fork</b>	RockShox Recon RL 120 Air Remote Q15x110 e-MTB Fox 34 Float Performance 120 3-Pos QR15x110 E-Bike Optimized
<b>Crankset</b>	FSA Bosch E-bike 14t Boost
<b>Crank</b>	Miranda Delta 152mm
<b>Headset</b>	ACROS 1-1/8 - 1-1/2" Integrated
<b>Handlebar</b>	Orbea 35mm Riser 780mm
<b>Stem</b>	Orbea 35mm interface
<b>Shifters</b>	Shimano Deore M6000
<b>Brakes</b>	Shimano MT201 Hydraulic Disc Shimano XT M8020 Hydraulic disc
<b>Rear Derailleur</b>	Shimano Deore M6000 GS Shadow Plus Direct Mount

<b>Chain</b>	Shimano SLX M7000 11-46t
<b>Wheels</b>	KMC e10 Turbo Silver Orbea Tryp 35c Disc Tubeless ready DT H-1700 Spline 30c TLR 15/110mm IS (6-bolt)
<b>Cassette</b>	Sun Race 11-42t 10-Speed
<b>Tyres</b>	Kenda 1184A Havok 27,5x2,8" 120TPI TLR (E-MTB specific)
<b>Pedals</b>	VPE-537 Black
<b>Seatpost</b>	Race Face Aeffect Dropper 31.6x385/125mm Crank brothers Highline 31,6x425/150mm
<b>Saddle</b>	Selle Royal 2077 DRN
<b>Lock</b>	Abus battery power tube lock
<b>Motor</b>	BOSCH Performance CX 25 kmh

<b>Battery</b>	BOSCH Performance 500Wh
----------------	-------------------------

<b>Display</b>	BOSCH Performance Purion
----------------	--------------------------



## ADVENTURE GUARANTEED

Among KERAM's features is a geometry designed for pedaling in a more comfortable and safer position than on traditional-style bikes. This is possible thanks primarily to the motor that will do part of the work of pedaling. To design an e-bike well, it is important to start with its features. KERAM is also an extremely easy product to ride, thanks to the agility of its steeply sloping frame and steering angle (among other factors) that make riding especially stable and safe.

**KERAM** MTB

# KERAM TECH



- 01 HYDEOUT TECHNOLOGY
- 02 DOUBLE DUTY
- 03 INTEGRATION
- 04 SPORT GEOMETRY
- 05 INTEGRATED KICKSTAND
- 06 VERSATILITY



Water bottle cage compatible.



## DOUBLE DUTY

The Keram will not only double your riding capacity with an optional Dual Battery System, but will also allow you to “on the go” install a water bottle cage or a lock thanks to our new Double Duty solution.



**\*OPTIONAL  
\*BATTERY NOT INCLUDED**







## HIDE-OUT TECH

Integrated battery fits smoothly with the frame shapes for great protection and a sleek appearance.

/ Tool-less battery access for convenience with a highly protected, rubber shielded charging port and Abus Plus lock.



## INTEGRATION

Having an sleek aesthetic and a well protected electric system plays a fundamental role in the new Keram.

All the way from the hidden battery to the chains-tays cable routing, our design offers a unique integration of the motor and related parts thanks to the specifically designed custom covers.



## SPORT GEOMETRY

Regardless of size, the keram will be easy to jump on and safe when riding thanks to his sharp sloping feature, all this without compromising the performance of the bike.

The variety of the users on Keram is big, and this concept tackles this issue.



## INTEGRATED KICKSTAND

The keram will optionally integrate a solid kickstand sleekly screwed within the forged frame drop-out.



## VERSATILE



The new Keram will adapt to a big variety of users with very different needs, reason why the bike will surely be compatible with the majority of the accessories you may think of:

- / Carrier Compatible
- / Lights
- / Fenders
- / Locks
- / Orbea Lifetime Warranty

## NEW KERAM

SIZES	S - 27.5"	M - 29"	L - 29"	XL - 29"
1 - Seat Tube (C-T)	400	405	457	515
2 - Top Tube (EFF)	538	569	603	547
3 - Head Tube	105	114	133	144
4 - Chainstay	475	475	475	475
5 - BB Height	307	313	313	313
6 - BB Drop	43	63	63	63
7 - Wheelbase	1112	1149	1173	980
8 - Head Angle	67	67	68	68
9 - Seat Angle	73	73	73	73
10 - Standover	798	825	861	893
11 - Reach	355	375	402	430
12 - Stack	600	636	659	752
13 - Fork Length	518	530	530	530

HEIGHT (cm)	HEIGHT (in)	SIZE
150-165	59.1"-65.0"	S
165-175	65.0"-68.9"	M
175-185	68.9"-72.8"	L
185-195	72.8"-76.8"	XL

-  Silver-Red (Matt)  
**XC**
-  Black (Matt-Gloss)  
**XB**
-  Steel Blue (Gloss-Matt)  
**XE**
-  Red (Gloss-Matt)  
**XD**

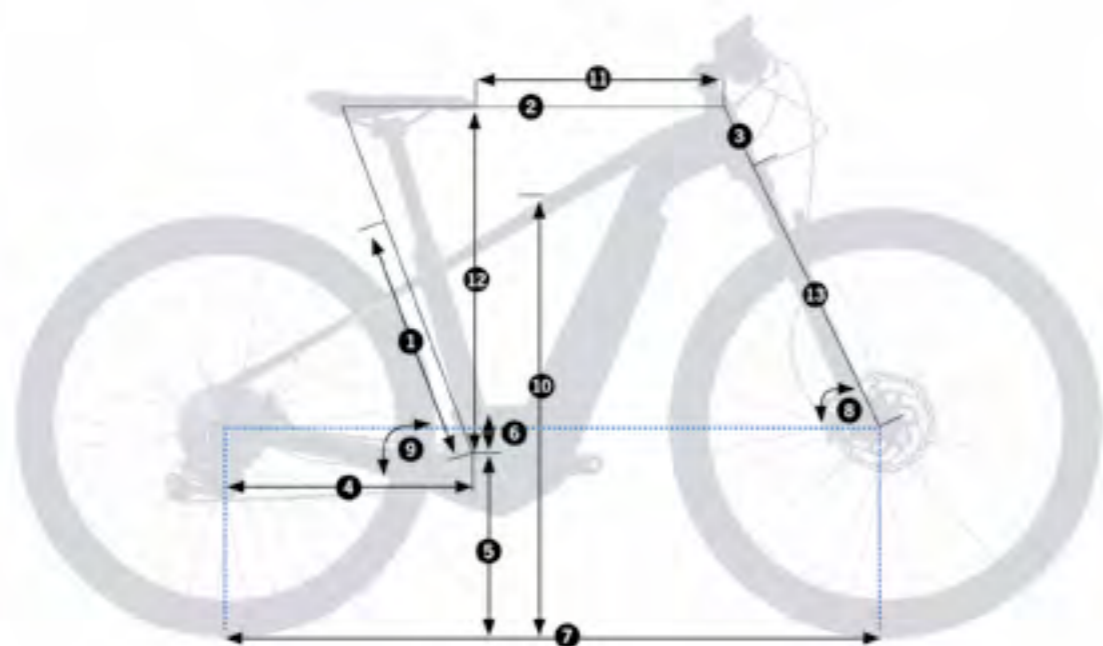

## KERAM

SIZES	S	M	L
1 - Seat Tube (C-T)	418	450	530
2 - Top Tube (EFF)	550	570	605
3 - Head Tube	130	130	150
4 - Chainstay	481	481	481
5 - BB Height	298	305	305
6 - BB Drop	52,5	63	63
7 - Wheelbase	1102	1133	1170
8 - Head Angle	69°	68°	68°
9 - Seat Angle	73°	73°	73°
10 - Standover	792	822	855
11 - Reach	360	374	403
12 - Stack	616	637	656
13 - Fork Length	490	508	658

HEIGHT (cm)	HEIGHT (in)	SIZE
150-165	59.1"-65.0"	S-27
165-175	65.0"-68.9"	M-29
175-185	68.9"-72.8"	L-29

-  Black-White (Matt)  
**Z1**
-  Electric Blue-Fluor Yellow (Matt)  
**Z3**

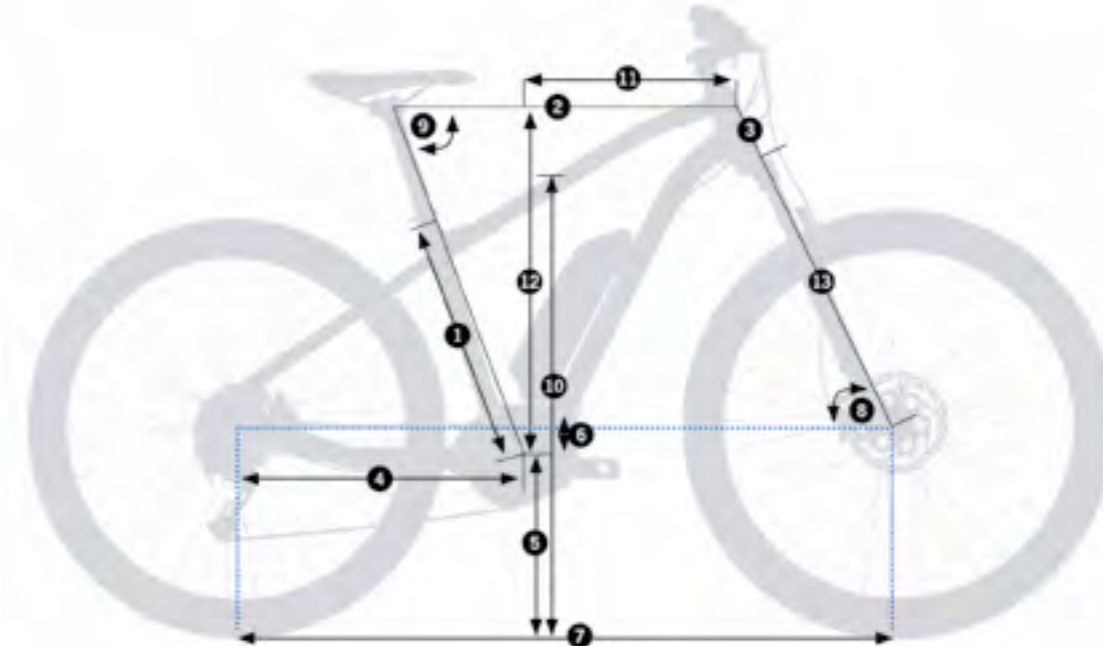

## KERAM MAX

MyO<sub>2</sub>™

Code	J319,J318		
Size	Crank	Stem	Handlebar
S-27	170	70	740
M-29	170	70	740
L-29	170	70	740
XL-29	170	70	740



<b>Frame</b>	Orbea Keram
<b>Fork</b>	RockShox Recon RL 120 Air Remote Q15x110 e-MTB
<b>Crankset</b>	Prowheel EB04 36t Prowheel EB04 38t w/chainguard
<b>Headset</b>	ACROS 1-1/8 - 1-1/2" Integrated
<b>Handlebar</b>	Orbea OC-I Riser 740mm
<b>Stem</b>	Orbea OC-II
<b>Shifters</b>	Shimano XT M8000
<b>Brakes</b>	Shimano MT400 Hydraulic Disc
<b>Rear Derailleur</b>	Shimano XT M8000 GS Shadow Plus Direct Mount
<b>Chain</b>	KMC e11 Turbo Silver
<b>Wheels</b>	Mach1 Klíxx 23c Tubeless Ready
<b>Cassette</b>	Sun Race 11-46t 11-Speed

<b>Tyres</b>	Maxxis Ikon 2.20" FB 60 TPI Dual
<b>Pedals</b>	VPE-537 Black
<b>Seatpost</b>	Orbea OC-I 31.6x400mm
<b>Saddle</b>	Selle Royal 2077 DRN
<b>Lock</b>	Abus battery down tube lock
<b>Quick stand</b>	Ursus Mooi 40mm rear adjustable
<b>Motor</b>	BOSCH Active Plus 25 kmh
<b>Battery</b>	BOSCH Performance 500Wh Dual Battery connection (no battery)
<b>Display</b>	BOSCH Performance Purion

## KERAM 10

MyO<sub>2</sub>™

Code	J317,J316		
Size	Crank	Stem	Handlebar
S-27	170	70	740
M-29	170	70	740
L-29	170	70	740



<b>Frame</b>	Orbea Keram, compatible 2,8mm tires
<b>Fork</b>	RockShox 30 Silver TK 100 Air Remote QR
<b>Crankset</b>	FSA Bosch E-bike 14t Boost
<b>Crank</b>	Miranda Delta 170mm
<b>Headset</b>	ACROS 1-1/8 - 1-1/2" Integrated
<b>Handlebar</b>	Orbea OC-I Riser 740mm
<b>Stem</b>	Orbea OC-II
<b>Shifters</b>	Shimano Deore M6000
<b>Brakes</b>	Shimano MT200 Hydraulic Disc
<b>Rear Derailleur</b>	Shimano Deore M6000 GS Shadow Plus
<b>Chain</b>	KMC e10 Turbo Silver
<b>Wheels</b>	Orbea Tryp 25c Disc Tubeless ready
<b>Cassette</b>	Sun Race 11-42t 10-Speed
<b>Tyres</b>	Kenda K1153 2,35" 30TPI

<b>Pedals</b>	VPE-537 Black
<b>Seatpost</b>	Orbea OC-I 31.6x400mm
<b>Saddle</b>	Selle Royal 2077 DRN
<b>Lock</b>	Abus battery down tube lock
<b>Motor</b>	BOSCH Performance CX 25 kmh
<b>Battery</b>	BOSCH Performance 500Wh Dual Battery connection (no battery)
<b>Display</b>	BOSCH Performance Purion

## KERAM 15

MyO<sub>2</sub>™

Code	J315,J314		
Size	Crank	Stem	Handlebar
S-27	170	70	740
M-29	170	70	740
L-29	170	70	740
XL-29	170	70	740



<b>Frame</b>	Orbea Keram
<b>Fork</b>	RockShox 30 Silver TK 100 Air Remote QR
<b>Crankset</b>	Prowheel EB04 36t Prowheel EB04 38t w/chainguard
<b>Headset</b>	ACROS 1-1/8 - 1-1/2" Integrated
<b>Handlebar</b>	Orbea OC-I Riser 740mm
<b>Stem</b>	Orbea OC-II
<b>Shifters</b>	Shimano Deore M6000
<b>Brakes</b>	Shimano MT200 Hydraulic Disc
<b>Rear Derailleur</b>	Shimano Deore M6000 GS Shadow Plus Direct Mount
<b>Chain</b>	KMC e10 Turbo Silver
<b>Wheels</b>	Orbea Tryp 25c Disc Tubeless ready
<b>Cassette</b>	Sun Race 11-42t 10-Speed

<b>Tyres</b>	Kenda K1153 2,35" 30TPI
<b>Pedals</b>	VPE-537 Black
<b>Seatpost</b>	Orbea OC-I 31.6x400mm
<b>Saddle</b>	Selle Royal 2077 DRN
<b>Lock</b>	Abus battery down tube lock
<b>Quick stand</b>	Ursus Mooi 40mm rear adjustable
<b>Motor</b>	BOSCH Active Plus 25 kmh
<b>Battery</b>	BOSCH Performance 500Wh Dual Battery connection (no battery)
<b>Display</b>	BOSCH Performance Purion

## KERAM 20

MyO<sub>2</sub>™

Code	J313,J312		
Size	Crank	Stem	Handlebar
S-27	170	70	740
M-29	170	70	740
L-29	170	70	740
XL-29	170	70	740



<b>Frame</b>	Orbea Keram
<b>Fork</b>	RockShox 30 Silver TK 100 Air Remote QR
<b>Crankset</b>	Prowheel EB04 36t Prowheel EB04 38t w/chainguard
<b>Headset</b>	ACROS 1-1/8 - 1-1/2" Integrated
<b>Handlebar</b>	Orbea OC-I Riser 740mm
<b>Stem</b>	Orbea OC-II
<b>Shifters</b>	Shimano Deore M6000
<b>Brakes</b>	Shimano MT200 Hydraulic Disc
<b>Rear Derailleur</b>	Shimano Deore M6000 GS Shadow Plus Direct Mount
<b>Chain</b>	KMC e10 Turbo Silver
<b>Wheels</b>	Orbea Black Rock 23c Disc
<b>Cassette</b>	Sun Race 11-42t 10-Speed

<b>Tyres</b>	Kenda K1153 2,35" 30TPI
<b>Pedals</b>	VPE-537 Black
<b>Seatpost</b>	Orbea OC-I 31.6x400mm
<b>Saddle</b>	Selle Royal 2077 DRN
<b>Lock</b>	Abus battery down tube lock
<b>Quick stand</b>	Ursus Mooi 40mm rear adjustable
<b>Motor</b>	BOSCH Active 25 kmh
<b>Battery</b>	BOSCH Performance 400Wh Dual Battery connection (no battery)
<b>Display</b>	BOSCH Performance Purion

# KERAM 30

<b>Code</b>	J311, J310
-------------	------------

Size	Crank	Stem	Handlebar
S-27	170	70	720
M-29	170	70	720
L-29	170	70	720



<b>Frame</b>	Orbea Keram, compatible 2,8mm tires
<b>Fork</b>	SR Suntour XCM LO Coil 100mm QR
<b>Crankset</b>	Prowheel EB04 36t Prowheel EB04 38t w/chainguard
<b>Headset</b>	ACROS 1-1/8 - 1-1/2" Integrated
<b>Handlebar</b>	Orbea OC Riser 720mm
<b>Stem</b>	Orbea OC
<b>Shifters</b>	Shimano Altus M2000
<b>Brakes</b>	Shimano MT200 Hydraulic Disc
<b>Rear Derailleur</b>	Shimano Altus M2000 SGS Shadow
<b>Chain</b>	KMC e9 Turbo Silver
<b>Wheels</b>	Orbea Black Rock 23c Disc
<b>Cassette</b>	Shimano HG200 11-36 9-Speed
<b>Tyres</b>	Kenda K1153 2,35" 22TPI

<b>Pedals</b>	VPE-537 Black
<b>Seatpost</b>	Orbea OC 31.6x400mm
<b>Saddle</b>	Selle Royal 2077 DRN
<b>Lock</b>	Abus battery down tube lock
<b>Motor</b>	BOSCH Active 25 kmh
<b>Battery</b>	BOSCH Performance 400Wh
<b>Display</b>	BOSCH Performance Purion



# URBAN

GAIN URBAN

KATU-E

KERAM ASPHALT / KERAM COMFORT

OPTIMA X35/

OPTIMA BOSCH COMFORT/ OPTIMA BOSCH ASPHALT



## ENHANCE YOUR RIDE

Gain was designed to enhance your ride, not dominate it. The Enough Power and Enough Energy concepts result in an exceptionally lightweight, sportive and rideable bike – a machine that heeds the call of the open road. Gain embraces your sweat and hard work and works in unison with your efforts to tick off the kilometers. System interfaces are modern, integrated and sleek. There are no bulky components to reduce the riding experience, distractions have been minimized so it's just you, Gain and the hours ahead.

**GAIN** URBAN



“WHERE IS THE BATTERY?”

“A DESIGN THAT PUTS THE GAIN AWAY FROM THE CONVENTIONAL EBIKES”.

“PERFECT FOR THOSE WHO WANTED A STYLISH EBIKE”.

GIZMODO

## MODE BUTTON

Save space on your handlebar for a GPS if you wish, or ride without clutter. Gain's control center is an attractive and discreet button on the top tube. With the simple iWoc ONE interface you can power the system on or off, check motor assist level and view the remaining battery charge. Colored LED lighting puts all the information you need right at your fingertips.

<<



## INTERNAL BATTERY

The battery is one of the most noticeable components of an eBike system, so every step has been taken to find the lightest, smallest and most discreet unit. Gain's Enough Energy concept provides you enough battery power, not more. It eliminates the need for a bulky, high-output battery that needs to be removed from the bike.



## DRIVE SYSTEM

The heart of Gain, the rear hub motor is the key to Gain's Enough Power concept. The sophisticated drive system provides enough smooth and reliable assistance at levels designed to enhance your ride, not dominate it. And since the motor is at the hub, you'll experience drag-free pedaling when Gain is not providing a push.





### C.A.N. INTEGRATION

Gain doesn't require a multitude of wires, ports or accessories. The CAN (Controller Area Network) bus port provides a single interface for charging, system diagnosis or attaching the external backup battery.



### P.A.S. SENSOR

Gain's smooth and balanced assist requires an advanced sensor. Blending perfectly with our effort to create a sleek and discrete system, the cassette lock ring holds 20 magnets that are detected by the integrated dropout sensor. The system monitors your pedaling input and adjusts power accordingly.

### APP

A smartphone and smartwatch compatible app enables deeper control of the iWoc system used by Gain. Ride tracking, activity and GPS route uploading and other functions are available from your mobile device, making Gain an even more valuable tool.



### VERSATILITY. MULTIPLE BIKES IN ONE

Gain is ready for many roles - Gravel, Road or Commuting. Tire clearance, the ability to mount accessories like mud guards combined with a functional All-Road Geometry means that Gain can change. Mount and secure aftermarket

fenders in a sleek and simple installation that is sturdy and attractive. Attach a rack for extra carrying capacity. Gain won't mind, it's what we intended when we created one of our our most versatile bikes.

**TIRE CLEARANCE.** The move to wider tires is happening everywhere, with even road racers opting for the comfort and lower rolling resistance of 25C or 28C tyres. To make Gain even more versatile it is possible to mount most 40C tyres, either with clincher or tubeless.

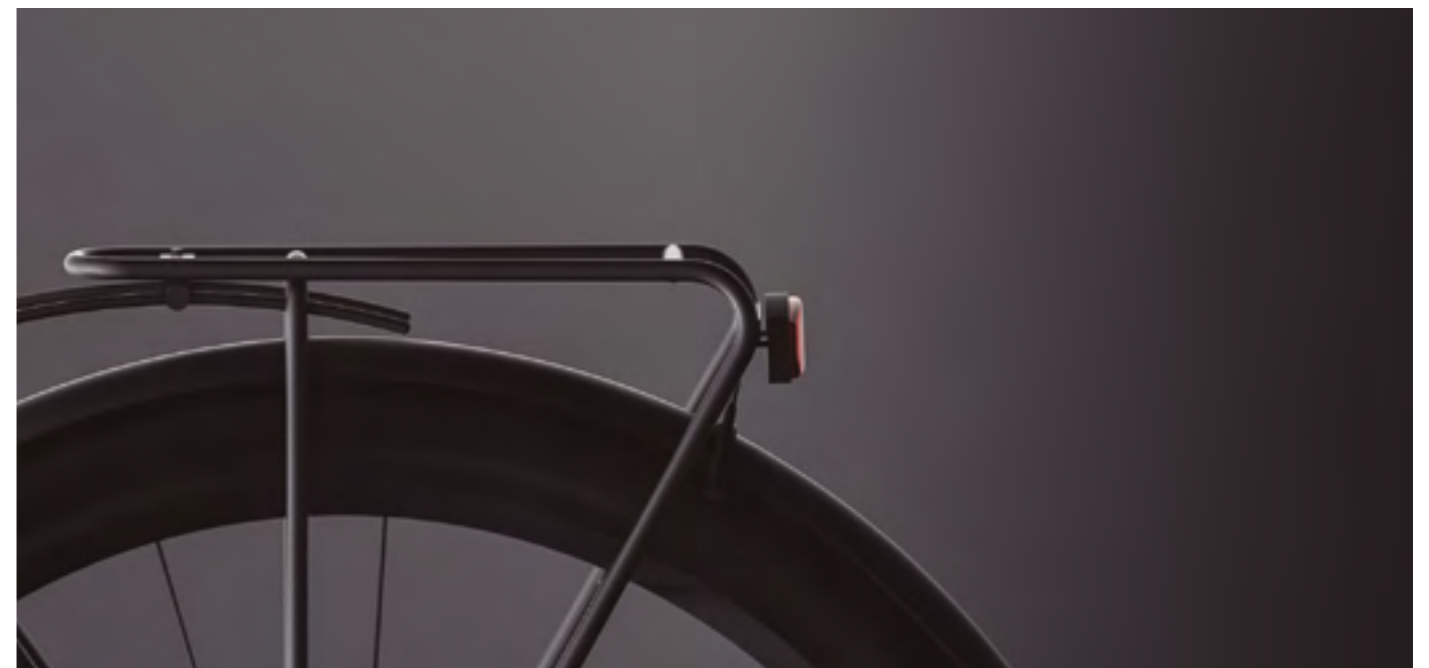

# GAIN H URBAN

SIZES	XS	S	M	L	XL
1 - Seat Tube (C-T)	460	510	555	585	610
2 - Top Tube (EFF)	526	544	560	572	595
3 - Head Tube	109	126	150	176	203
4 - Chainstay	430	430	430	430	430
5 - BB Height	70	70	68	68	66
6 - BB Drop	281	281	283	283	285
7 - Wheelbase	1016	1022	1037	1051	1067
8 - Head Angle	71	72	72	72	72,3
9 - Seat Angle	74,5	74	74	74	73,5
11 - Reach	378	387	395	402	410
12 - Stack	535	555	575	600	625
13 - Fork Length	400	400	400	400	400

HEIGHT (cm)	HEIGHT (in)	SIZE
<160	<63.0"	XS
160-170	63.0"-66.9"	S
170-180	66.9"-70.9"	M
180-190	70.9"-74.8"	L
>190	>74.8"	XL

- Green (Matt-Gloss) X5
- Black (Matt-Gloss) X4
- Blue (Matt-Gloss) X6
- Bright Red-Black (Matt-Gloss) X7

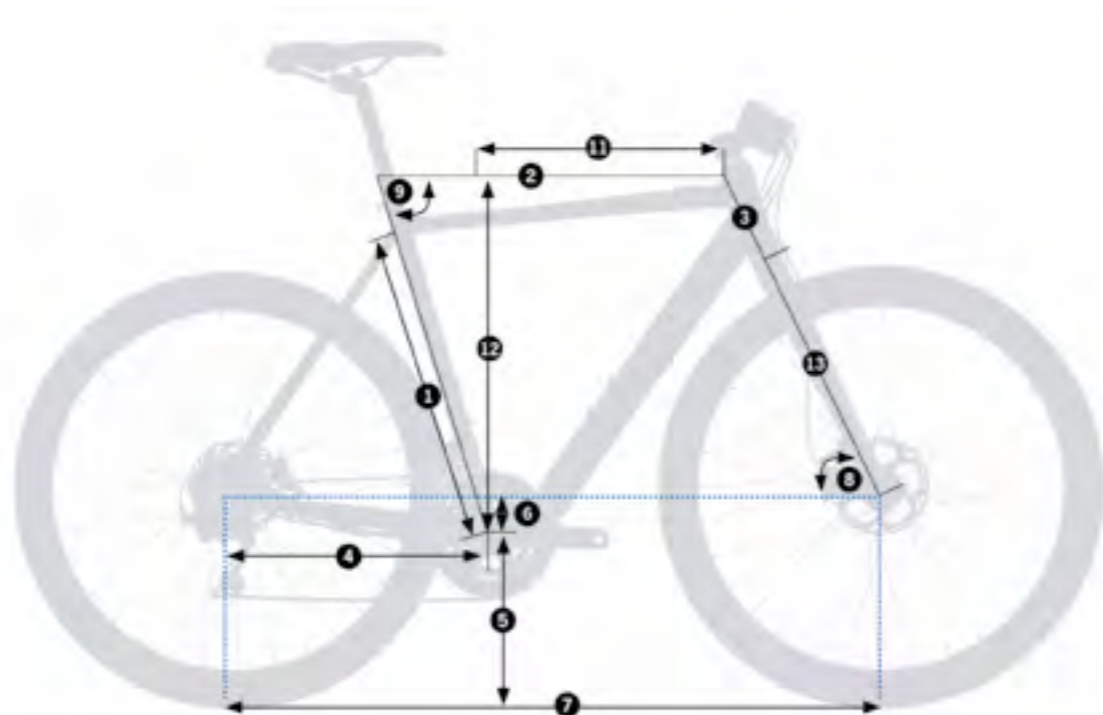

# GAIN F10

MyO<sub>2.0</sub>

Code	J355		
Size	Crank	Stem	Handlebar
XS	170	75	680
S	170	75	680
M	170	75	680
L	170	75	680
XL	170	75	680



<b>Frame</b>	Orbea Gain
<b>Fork</b>	Speed 400mm Carbon Flat mount
<b>Crankset</b>	Prowheel 42 Steel Custom logo
<b>Headset</b>	1-1/8" Semi-Integrated
<b>Handlebar</b>	Orbea AL320 Riser 680mm
<b>Grips</b>	Brooks Cambium 130mm
<b>Stem</b>	Orbea TDS-C301
<b>Shifters</b>	Shimano Deore M6000
<b>Brakes</b>	Shimano MT201 Hydraulic Disc
<b>Rear Derailleur</b>	Shimano Deore M6000 GS Shadow Plus
<b>Chain</b>	KMC e10 Turbo Silver
<b>Wheels</b>	Airline Corsa
<b>Cassette</b>	Sun Race 11-42t 10-Speed



<b>Hub</b>	Safety Lock
<b>Tyres</b>	Kenda K1067 700x38C Reflective type+puncture protection
<b>Pedals</b>	VPE-537 Black
<b>Seatpost</b>	Orbea C255 27.2x300mm
<b>Saddle</b>	Brooks Cambium C17 165mm wide
<b>Rear carrier</b>	Tubus Fly
<b>Mudguard</b>	Orbea SKS 46S 700x45C Black
<b>Front light</b>	Joss Spanninga Kendo Steps
<b>Rear light</b>	Spanninga Pixeo
<b>Quick stand</b>	Ursus Mooi 40mm rear adjustable
<b>Motor</b>	Ebikemotion X35
<b>Battery</b>	Ebikemotion 36V/6.9A

<b>Remote 2</b>	Ebikemotion iWoc TRIO
<b>Remote 1</b>	Ebikemotion iWoc ONE

# GAIN F20

MyO<sub>2.0</sub>

Code	J354		
Size	Crank	Stem	Handlebar
XS	170	70	640
S	170	70	640
M	170	70	640
L	170	70	640
XL	170	70	640



<b>Frame</b>	Orbea Gain
<b>Fork</b>	Speed 400mm Carbon Flat mount
<b>Crankset</b>	Shimano 105 R7000 34x50t
<b>Headset</b>	1-1/8" Semi-Integrated
<b>Handlebar</b>	Orbea OC-I Riser 640mm
<b>Stem</b>	Orbea OC-II
<b>Shifters</b>	Shimano SL-SR700
<b>Brakes</b>	Shimano MT201 Hydraulic Disc
<b>Rear Derailleur</b>	Shimano 105 R7000 GS
<b>Front Derailleur</b>	Shimano 105 R7000
<b>Chain</b>	KMC e11 Turbo Silver
<b>Wheels</b>	Airline Corsa
<b>Cassette</b>	Shimano 105 R7000 11-32t 11-Speed
<b>Hub</b>	Safety Lock



<b>Tyres</b>	Kenda K1067 700x38C Reflective type+puncture protection
<b>Pedals</b>	VPE-537 Black
<b>Seatpost</b>	Orbea OC-I 27.2x350mm
<b>Saddle</b>	Selle Royal Scientia A2
<b>Rear carrier</b>	Tubus Fly
<b>Mudguard</b>	Orbea SKS 46S 700x45C + Spanninga Kendo(F)/Pixeo(R) Lights Orbea SKS 46S 700x45C Black
<b>Front light</b>	
<b>Rear light</b>	
<b>Quick stand</b>	Ursus Mooi 40mm rear adjustable

<b>Motor</b>	Ebikemotion X35
<b>Battery</b>	Ebikemotion 36V/6.9A
<b>Remote 2</b>	Ebikemotion iWoc TRIO
<b>Remote 1</b>	Ebikemotion iWoc ONE

## GAIN F30

MyO<sub>2</sub>

Code	J353		
<b>Size</b>	<b>Crank</b>	<b>Stem</b>	<b>Handlebar</b>
XS	170	70	640
S	170	70	640
M	170	70	640
L	170	70	640
XL	170	70	640



<b>Frame</b>	Orbea Gain
<b>Fork</b>	Speed 400mm Carbon Flat mount
<b>Crankset</b>	Shimano Claris R2000 34x50t
<b>Headset</b>	1-1/8" Semi-Integrated
<b>Handlebar</b>	Orbea OC-I Riser 640mm
<b>Stem</b>	Orbea OC-II
<b>Shifters</b>	Shimano Claris SL-R2000-R
<b>Brakes</b>	Shimano MT200 Hydraulic Disc
<b>Rear Derailleur</b>	Shimano Claris RD-R2000-GS
<b>Front Derailleur</b>	Shimano Claris FD-R2000-F
<b>Chain</b>	KMC X8
<b>Wheels</b>	Airline Corsa
<b>Cassette</b>	Shimano HG50 11-34t 8-Speed
<b>Hub</b>	Safety Lock



<b>Tyres</b>	Kenda K1067 700x38C Reflective type+puncture protection
<b>Pedals</b>	VPE-537 Black
<b>Seatpost</b>	Orbea OC-I 27.2x350mm
<b>Saddle</b>	Selle Royal Scientia A2
<b>Rear carrier</b>	Tubus Fly
<b>Mudguard</b>	Orbea SKS 46S 700x45C + Spanninga Kendo(F)/Pixeo(R) Lights Orbea SKS 46S 700x45C Black
<b>Front light</b>	
<b>Rear light</b>	
<b>Quick stand</b>	Ursus Mooi 40mm rear adjustable

<b>Motor</b>	Ebikemotion X35
<b>Battery</b>	Ebikemotion 36V/6.9A
<b>Remote 2</b>	Ebikemotion iWoc TRIO
<b>Remote 1</b>	Ebikemotion iWoc ONE

## GAIN F40

MyO<sub>2</sub>

Code	J352		
<b>Size</b>	<b>Crank</b>	<b>Stem</b>	<b>Handlebar</b>
XS	170	70	640
S	170	70	640
M	170	70	640
L	170	70	640
XL	170	70	640



<b>Frame</b>	Orbea Gain
<b>Fork</b>	Speed 400mm Carbon Flat mount
<b>Crankset</b>	Prowheel 42 Steel Custom logo
<b>Headset</b>	1-1/8" Semi-Integrated
<b>Handlebar</b>	Orbea OC-I Riser 640mm
<b>Stem</b>	Orbea OC-II
<b>Shifters</b>	Shimano Altus M2000
<b>Brakes</b>	Shimano MT200 Hydraulic Disc
<b>Rear Derailleur</b>	Shimano Altus M2000 SGS Shadow
<b>Chain</b>	KMC e9 Turbo Silver
<b>Wheels</b>	Airline Corsa
<b>Cassette</b>	Shimano HG200 11-36 9-Speed
<b>Hub</b>	Safety Lock



<b>Tyres</b>	Kenda K1067 700x38C Reflective type+puncture protection
<b>Pedals</b>	VPE-537 Black
<b>Seatpost</b>	Orbea OC-I 27.2x350mm
<b>Saddle</b>	Selle Royal Scientia A2
<b>Rear carrier</b>	Tubus Fly
<b>Mudguard</b>	Orbea SKS 46S 700x45C + Spanninga Kendo(F)/Pixeo(R) Lights Orbea SKS 46S 700x45C Black
<b>Front light</b>	
<b>Rear light</b>	
<b>Quick stand</b>	Ursus Mooi 40mm rear adjustable

<b>Motor</b>	Ebikemotion X35
<b>Battery</b>	Ebikemotion 36V/6.9A
<b>Remote 2</b>	Ebikemotion iWoc TRIO
<b>Remote 1</b>	Ebikemotion iWoc ONE



## UNIQUELY UNIVERSAL

The world is continually evolving. Our customs, spaces and needs have reached a turning point. Katu is a platform that is especially sensitive to the new way in which we move about the city, designed for both those who want to get started in urban cycling and those who are already very experienced or even professionals. Practicality, style, environmental friendliness and urban coexistence are the main pillars of this new product that we introduce to you in different electric and non-electric versions. Enjoy discovering everything about the Katu, from the general concept to how we've taken care of every last detail

**KATU - E**



### KATU IS SOLID AND DURABLE

- / Full Sized Bike Ride Quality
- / Aluminium Frame
- / 20" Wheels
- / Orbea Lifetime Warranty



### URBAN ESSENCE

- / Front and Rear Lights
- / Reflective Tires
- / Comfortable Saddle
- / Frame Lock\*
- / Kickstand

### KATU IS FOR EVERYONE

- / One Size Fits All
- / Universal Product Range
- / Adjustable System
- / Eight Colors

### KATU IS CAPABLE

- / Front Basket Included
- / Rear Basket Optional
- / Child Seat Compatible



# KATU-E

SIZES	U
1 - Seat Tube (C-T)	468 (BAFAN 458)
2 - Top Tube (EFF)	575
3 - Head Tube	250
4 - Chainstay	440
5 - BB Height	268
6 - BB Drop	18
7 - Wheelbase	1096
8 - Head Angle	67.7°
9 - Seat Angle	70.3°
10 - Standover	655
11 - Reach	401
12 - Stack	531
13 - Fork Length	355

- Magnetic Black (Matt) S1
- Supergreen (Matt) S2
- Bone White (Matt) S3
- Fresh Green (Matt) S4
- Nordic Blue (Matt) S5
- Etheric Silver (Matt) S6
- Bordeaux (Matt) S7
- Almost Red (Matt) S8

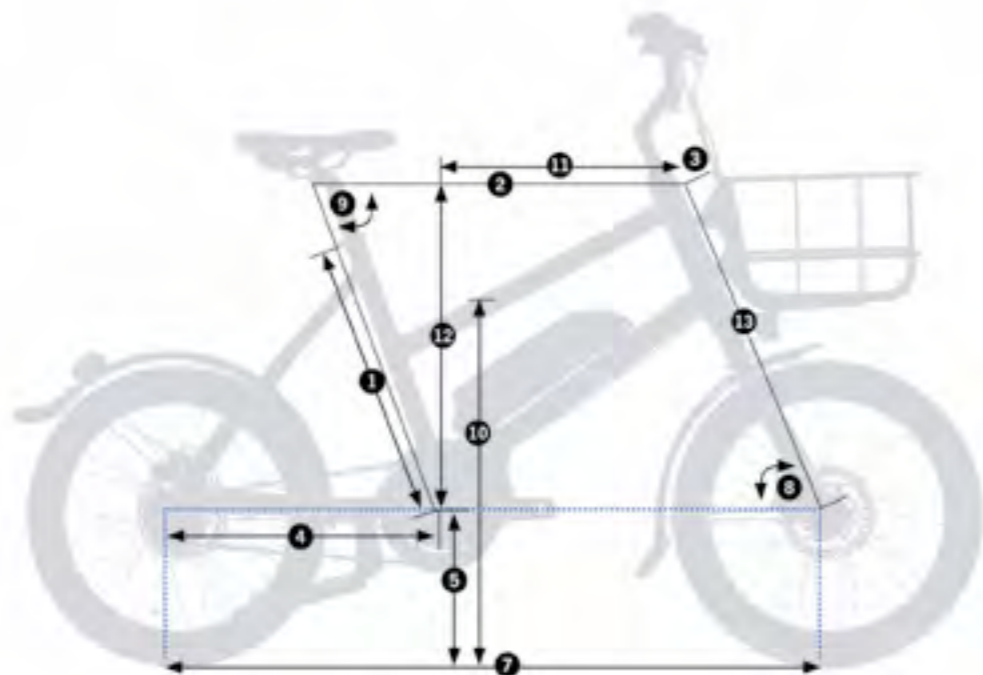

# KATU-E 10

MyO<sub>2.0</sub>

Code	J303		
Size	Crank	Stem	Handlebar
20	152	150	660



<b>Fork</b>	Orbea Katu
<b>Crankset</b>	Alloy 22t
<b>Crank</b>	Miranda Delta 152mm
<b>Headset</b>	1-1/8" Semi-Integrated
<b>Handlebar</b>	Orbea City Riser Alu 660mm
<b>Grips</b>	Ergonomic w/lock
<b>Stem</b>	Orbea Alu
<b>Shifters</b>	Shimano XT M8000
<b>Brakes</b>	Shimano MT200 Hydraulic Disc
<b>Rear Derailleur</b>	Shimano XT M8000 GS Shadow Plus
<b>Chain</b>	KMC e11 Turbo Silver
<b>Wheels</b>	Orbea Web Disc
<b>Cassette</b>	Sun Race 11-40t 11-Speed
<b>Hub</b>	Safety Lock



<b>Tyres</b>	Kenda 841 20x2.25 Reflex
<b>Pedals</b>	VP-615 Black
<b>Seatpost</b>	Orbea OC-I 31.6x400mm
<b>Saddle</b>	Selle Royal Milo Plus DR
<b>Front basket</b>	Aluminium Front Basket
<b>Mudguard</b>	SKS 20" 60mm
<b>Front light</b>	Spanninga Kendo 15 lux
<b>Rear light</b>	Spanninga Pixeo
<b>Chainguard</b>	Horn Catena ES
<b>Lock</b>	Abus Pro Shield Plus+battery downtube lock
<b>Quick stand</b>	Ursus Mooi adjust
<b>Motor</b>	BOSCH Performance CX 25 kmh
<b>Battery</b>	BOSCH Performance 500Wh

<b>Display</b>	BOSCH Performance Purion
----------------	--------------------------

# KATU-E 20

MyO<sub>2.0</sub>

Code	J302		
Size	Crank	Stem	Handlebar
20	170	150	660



<b>Frame</b>	Orbea Katu 20"
<b>Fork</b>	Orbea Katu
<b>Crankset</b>	FSA Bosch-IG3 E-bike 44t
<b>Crank</b>	FSA CK-602 Bosch IG3 170mm
<b>Headset</b>	1-1/8" Semi-Integrated
<b>Handlebar</b>	Orbea City Riser Alu 660mm
<b>Stem</b>	Orbea Alu
<b>Shifters</b>	Shimano SL-C6000 Nexus 8-Speed
<b>Brakes</b>	Shimano MT200 Hydraulic Disc
<b>Chain</b>	KMC Z510HX
<b>Wheels</b>	Orbea Web Disc
<b>Cassette</b>	Shimano Nexus 18t
<b>Hub</b>	Safety Lock
<b>Tyres</b>	Kenda 841 20x2.25 Reflex



<b>Pedals</b>	VP-615 Black
<b>Seatpost</b>	Orbea OC-I 31.6x400mm
<b>Saddle</b>	Selle Royal Milo Plus DR
<b>Front basket</b>	Aluminium Front Basket
<b>Mudguard</b>	SKS 20" 60mm
<b>Front light</b>	Spanninga Kendo 15 lux
<b>Rear light</b>	Spanninga Pixeo
<b>Chainguard</b>	FSA Bosch IG3 44-46t
<b>Lock</b>	Abus battery down tube lock Abus Pro Shield Plus frame lock+battery downtube lock
<b>Quick stand</b>	Ursus Big Foot double central alloy
<b>Motor</b>	BOSCH Active Plus 25 kmh
<b>Battery</b>	BOSCH Performance 500Wh

<b>Display</b>	BOSCH Performance Purion
----------------	--------------------------

# KATU-E 30

Code	J301		
Size	Crank	Stem	Handlebar
20	170	150	660



<b>Frame</b>	Orbea Katu 20"
<b>Fork</b>	Orbea Katu
<b>Crankset</b>	FSA Bosch-IG3 E-bike 44t
<b>Crank</b>	FSA CD-200 Bosch IG3 170mm
<b>Headset</b>	1-1/8" Semi-Integrated
<b>Handlebar</b>	Orbea City Riser Alu 660mm
<b>Stem</b>	Orbea Alu
<b>Shifters</b>	Sturmey Archer TSC50 5-Speed Twist
<b>Brakes</b>	Shimano MT200 Hydraulic Disc
<b>Chain</b>	KMC Z510HX
<b>Wheels</b>	Orbea Web Disc
<b>Cassette</b>	Sturmey Archer CSIRW 18t
<b>Hub</b>	Safety Lock
<b>Tyres</b>	Kenda 841 20x2.25 Reflex

<b>Pedals</b>	VPE-537 Black
<b>Seatpost</b>	Orbea OC 31.6x400mm
<b>Saddle</b>	Selle Royal One 6007 DR Selle Royal Milo Plus DR
<b>Front basket</b>	Aluminium Front Basket
<b>Mudguard</b>	SKS 20" 60mm
<b>Front light</b>	Spanninga Kendo 15 lux
<b>Rear light</b>	Spanninga Pixeo
<b>Chainguard</b>	FSA Bosch IG3 44-46t
<b>Lock</b>	Abus battery down tube lock Abus Pro Shield Plus frame lock+battery downtube lock
<b>Quick stand</b>	Ursus Big Foot double central alloy
<b>Motor</b>	BOSCH Active 25 kmh

<b>Battery</b>	BOSCH Performance 400Wh
<b>Display</b>	BOSCH Performance Purion





## ADVENTURE GUARANTEED

Among KERAM's features is a geometry designed for pedaling in a more comfortable and safer position than on traditional-style bikes. This is possible thanks primarily to the motor that will do part of the work of pedaling. To design an e-bike well, it is important to start with its features. KERAM is also an extremely easy product to ride, thanks to the agility of its steeply sloping frame and steering angle (among other factors) that make riding especially stable and safe.

**KERAM ASPHALT**  
**KERAM COMFORT**





Water bottle cage compatible.



## DOUBLE DUTY

The Keram will not only double your riding capacity with an optional Dual Battery System, but will also allow you to “on the go” install a water bottle cage or a lock thanks to our new Double Duty solution.



**\*OPTIONAL  
\*BATTERY NOT INCLUDED**





## HIDE-OUT TECH

Integrated battery fits smoothly with the frame shapes for great protection and a sleek appearance.

/ Tool-less battery access for convenience with a highly protected, rubber shielded charging port and Abus Plus lock.



## INTEGRATION

Having an sleek aesthetic and a well protected electric system plays a fundamental role in the new Keram.

All the way from the hidden battery to the chains-tays cable routing, our design offers a unique integration of the motor and related parts thanks to the specifically designed custom covers.



## SPORT GEOMETRY

Regardless of size, the keram will be easy to jump on and safe when riding thanks to his sharp sloping feature, all this without compromising the performance of the bike.

The variety of the users on Keram is big, and this concept tackles this issue.



## INTEGRATED KICKSTAND

The keram will optionally integrate a solid kickstand sleekly screwed within the forged frame drop-out.



## VERSATILE

The new Keram will adapt to a big variety of users with very different needs, reason why the bike will surely be compatible with the majority of the accessories you may think of:

- / Carrier Compatible
- / Lights
- / Fenders
- / Locks
- / Orbea Lifetime Warranty



## NEW KERAM URBAN

SIZES	S - 27.5"	M - 29"	L - 29"	XL - 29"
1 - Seat Tube (C-T)	400	405	457	515
2 - Top Tube (EFF)	538	569	603	547
3 - Head Tube	105	114	133	144
4 - Chainstay	475	475	475	475
5 - BB Height	307	313	313	313
6 - BB Drop	43	63	63	63
7 - Wheelbase	1112	1149	1173	980
8 - Head Angle	67	67	68	68
9 - Seat Angle	73	73	73	73
10 - Standover	798	825	861	893
11 - Reach	355	375	402	430
12 - Stack	600	636	659	752
13 - Fork Length	518	530	530	530

HEIGHT (cm)	HEIGHT (in)	SIZE
150-165	59.1"-65.0"	S
165-175	65.0"-68.9"	M
175-185	68.9"-72.8"	L
185-195	72.8"-76.8"	XL

- Blue Indigo (Gloss) X8
- Green (Matt) X9
- Titanium (Gloss) XA

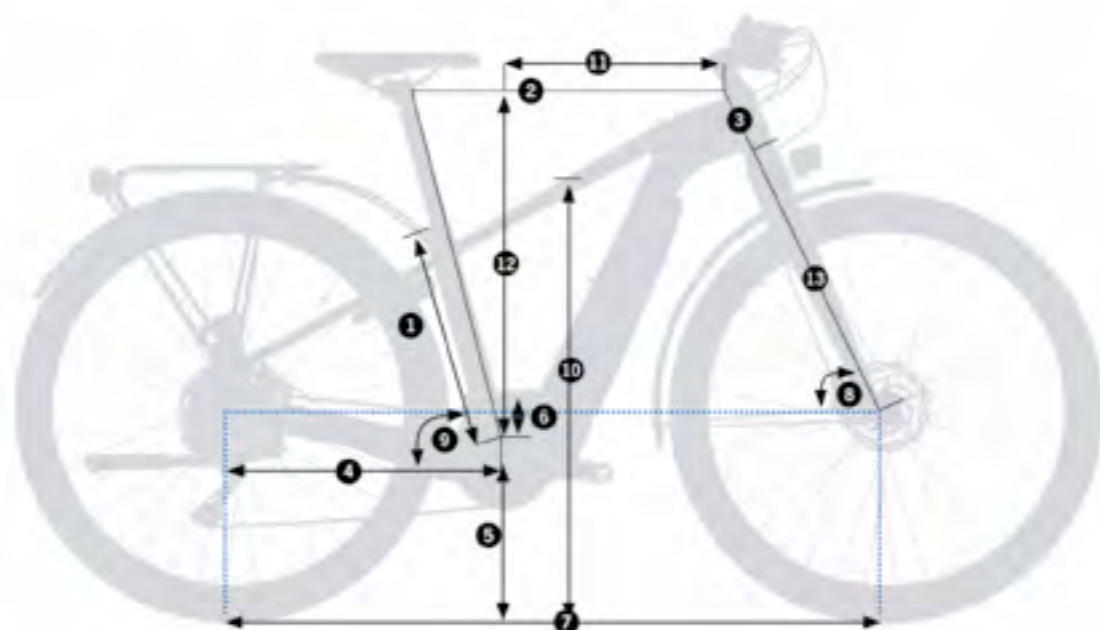

## KERAM ASPHALT 20 *MyO<sub>2.0</sub>*

Code	J341		
Size	Crank	Stem	Handlebar
S	170	90	660
M	170	90	660
L	170	90	660
XL	170	90	660



<b>Frame</b>	Orbea Keram
<b>Fork</b>	Orbea Keram Urban Alu Tapered
<b>Crankset</b>	Prowheel EB04 38t w/chainguard
<b>Headset</b>	ACROS 1-1/8 - 1-1/2" Integrated
<b>Handlebar</b>	Orbea Comfort Riser Alu 660mm
<b>Stem</b>	Orbea OC-II
<b>Shifters</b>	Shimano Deore M6000
<b>Brakes</b>	Shimano MT200 Hydraulic Disc
<b>Rear Derailleur</b>	Shimano Deore M6000 GS Shadow Plus Direct Mount
<b>Chain</b>	KMC e10 Turbo Silver
<b>Wheels</b>	Orbea Black Rock 23c Disc
<b>Cassette</b>	Sun Race 11-42t 10-Speed
<b>Hub</b>	Safety Lock



<b>Tyres</b>	Kenda 1052 29x2.0
<b>Pedals</b>	VP-615 Black
<b>Seatpost</b>	Orbea OC-I 31.6x400mm
<b>Saddle</b>	Selle Royal 2077 DRN Selle Royal Looking Moderate DRO 3D Gel
<b>Rear carrier</b>	Alloy Rear Carrier
<b>Mudguard</b>	Orbea SKS EDGE Alu C56R
<b>Front light</b>	Joss Spanninga Axendo XE
<b>Rear light</b>	Spanninga Lineo
<b>Lock</b>	Abus Pro Shield Plus+battery downtube lock
<b>Quick stand</b>	Ursus Mooi 40mm rear adjustable
<b>Motor</b>	BOSCH Active Plus 25 kmh
<b>Battery</b>	BOSCH Performance 500Wh

<b>Display</b>	Dual Battery connection (no battery) BOSCH Performance Purion
----------------	--

## KERAM ASPHALT 30 *MyO<sub>2.0</sub>*

Code	J340		
Size	Crank	Stem	Handlebar
S	170	90	660
M	170	90	660
L	170	90	660
XL	170	90	660



<b>Frame</b>	Orbea Keram
<b>Fork</b>	Orbea Keram Urban Alu Tapered
<b>Crankset</b>	Prowheel EB04 38t w/chainguard
<b>Headset</b>	ACROS 1-1/8 - 1-1/2" Integrated
<b>Handlebar</b>	Orbea Comfort Riser Alu 660mm
<b>Stem</b>	Orbea OC-II
<b>Shifters</b>	Shimano Altus M2000
<b>Brakes</b>	Shimano MT200 Hydraulic Disc
<b>Rear Derailleur</b>	Shimano Altus M2000 SGS Shadow
<b>Chain</b>	KMC e9 Turbo Silver
<b>Wheels</b>	Orbea Black Rock 23c Disc
<b>Cassette</b>	Shimano HG200 11-36 9-Speed
<b>Hub</b>	Safety Lock
<b>Tyres</b>	Kenda 1052 29x2.0



<b>Pedals</b>	VP-615 Black
<b>Seatpost</b>	Orbea OC-I 31.6x400mm
<b>Saddle</b>	Selle Royal 2077 DRN Selle Royal Looking Moderate DRO 3D Gel
<b>Rear carrier</b>	Alloy Rear Carrier
<b>Mudguard</b>	SKS 28" 65mm Orbea SKS EDGE Alu C56R
<b>Front light</b>	Spanninga Kendo 15 lux Joss Spanninga Axendo XE
<b>Rear light</b>	Spanninga Lineo
<b>Lock</b>	Abus Pro Shield Plus+battery downtube lock
<b>Quick stand</b>	Ursus Mooi 40mm rear adjustable
<b>Motor</b>	BOSCH Active 25 kmh

<b>Battery</b>	BOSCH Performance 400Wh Dual Battery connection (no battery)
<b>Display</b>	BOSCH Performance Purion

## KERAM COMFORT 20 MyO.com

Code	J343		
<b>Size</b>	<b>Crank</b>	<b>Stem</b>	<b>Handlebar</b>
S	170	90	660
M	170	90	660
L	170	90	660
XL	170	90	660



<b>Frame</b>	Orbea Keram
<b>Fork</b>	SR Suntour NEX E-25 63mm Disc
<b>Crankset</b>	Prowheel EB04 38t w/chainguard
<b>Headset</b>	ACROS 1-1/8 - 1-1/2" Integrated
<b>Handlebar</b>	Orbea Comfort Riser Alu 660mm
<b>Stem</b>	Orbea Black Adjustable
<b>Shifters</b>	Shimano Deore M6000
<b>Brakes</b>	Shimano MT200 Hydraulic Disc
<b>Rear Derailleur</b>	Shimano Deore M6000 GS Shadow Plus Direct Mount
<b>Chain</b>	KMC e10 Turbo Silver
<b>Wheels</b>	Orbea Black Rock 23c Disc
<b>Cassette</b>	Sun Race 11-42t 10-Speed
<b>Hub</b>	Safety Lock

<b>Tyres</b>	Kenda 1172 700x50c
<b>Pedals</b>	VP-615 Black
<b>Seatpost</b>	Orbea OC-I 31.6x400mm
<b>Saddle</b>	Selle Royal 2077 DRN Selle Royal Looking Moderate DRO 3D Gel
<b>Rear carrier</b>	Alloy Rear Carrier
<b>Mudguard</b>	Orbea SKS EDGE Alu C56R
<b>Front light</b>	Joss Spanninga Axendo XE
<b>Rear light</b>	Spanninga Lineo
<b>Lock</b>	Abus Pro Shield Plus+battery downtube lock
<b>Quick stand</b>	Ursus Mooi 40mm rear adjustable
<b>Motor</b>	BOSCH Active Plus 25 kmh
<b>Battery</b>	BOSCH Performance 500Wh

	Dual Battery connection (no battery)
<b>Display</b>	BOSCH Performance Purion

## KERAM COMFORT 30 MyO.com

Code	J342		
<b>Size</b>	<b>Crank</b>	<b>Stem</b>	<b>Handlebar</b>
S	170	90	660
M	170	90	660
L	170	90	660
XL	170	90	660



<b>Frame</b>	Orbea Keram
<b>Fork</b>	SR Suntour NEX E-25 63mm Disc
<b>Crankset</b>	Prowheel EB04 38t w/chainguard
<b>Headset</b>	ACROS 1-1/8 - 1-1/2" Integrated
<b>Handlebar</b>	Orbea Comfort Riser Alu 660mm
<b>Stem</b>	Orbea Black Adjustable
<b>Shifters</b>	Shimano Altus M2000
<b>Brakes</b>	Shimano MT200 Hydraulic Disc
<b>Rear Derailleur</b>	Shimano Altus M2000 SGS Shadow
<b>Chain</b>	KMC e9 Turbo Silver
<b>Wheels</b>	Orbea Black Rock 23c Disc
<b>Cassette</b>	Shimano HG200 11-36 9-Speed
<b>Hub</b>	Safety Lock
<b>Tyres</b>	Kenda 1172 700x50c

<b>Pedals</b>	VP-615 Black
<b>Seatpost</b>	Orbea OC-I 31.6x400mm
<b>Saddle</b>	Selle Royal 2077 DRN Selle Royal Looking Moderate DRO 3D Gel
<b>Rear carrier</b>	Alloy Rear Carrier
<b>Mudguard</b>	SKS 28" 65mm Orbea SKS EDGE Alu C56R
<b>Front light</b>	Spanninga Kendo 15 lux Joss Spanninga Axendo XE
<b>Rear light</b>	Spanninga Lineo
<b>Lock</b>	Abus Pro Shield Plus+battery downtube lock
<b>Quick stand</b>	Ursus Mooi 40mm rear adjustable
<b>Motor</b>	BOSCH Active 25 kmh

<b>Battery</b>	BOSCH Performance 400Wh
	Dual Battery connection (no battery)
<b>Display</b>	BOSCH Performance Purion



## IT'S ALL ABOUT **BALANCE**

Optima is an apparently “normal” bicycle, but both the architecture and the ergonomics of the new Optima are innovative. It is a bike designed to be used as an electric bicycle from the conceptual design phase. This has meant revamping the product to the point that even its architecture changed.

**OPTIMA X35**  
**OPTIMA BOSCH ASPHALT**  
**OPTIMA BOSCH COMFORT**



### REMOTE

A compact iWoc TRIO controller adds functionality and interaction to Optima, adding more control over the lighting, battery and assist level of your bike.

### C.A.N. INTEGRATION

Optima doesn't require a multitude of wires, ports or accessories. The CAN (Controller Area Network) bus port provides a single interface for charging, system diagnosis or attaching the external backup battery.





### PAS SENSOR

Optima's smooth and balanced assist requires an advanced sensor. Blending perfectly with our effort to create a sleek and discrete system, the cassette lock ring holds 20 magnets that are detected by the integrated dropout sensor. The system monitors your pedaling input and adjusts power accordingly.



### DRIVE SYSTEM

The heart of Optima, the rear hub motor is the key to Optima's Enough Power concept. The sophisticated drive system provides enough smooth and reliable assistance at levels designed to enhance your ride, not dominate it. And since the motor is at the hub, you'll experience drag-free pedaling when Optima is not providing a push.



### INTERNAL BATTERY

The battery is one of the most noticeable components of an eBike system, so every step has been taken to find the lightest, smallest and most discreet unit. Optimas's Enough Energy concept provides you enough battery power, not more. It eliminates the need for a bulky, high-output battery that needs to be removed from the bike.



### APP

A smartphone and smartwatch compatible app enables deeper control of the iWoc system used by Optima. Ride tracking, activity and GPS route uploading and other functions are available from your mobile device, making Optima an even more valuable tool.



### VERSATILITY

#### COMFORTABLE

- / Easy Access
- / Balanced City Geometry
- / Comfortable Grips and Saddles
- / Weatherproof
- / Wide Gear Ratio
- / Lightweight Alloy Frame
- / Big Tires

#### URBAN ESSENCE

- / Lights, Front and Rear
- / Frame Lock\*
- / Fenders + Chainguard
- / Kickstand
- / Orbea Lifetime Warranty
- / Colorful Frames and Details



## OPTIMA X35

SIZES	S	M	L
1 - Seat Tube (C-T)	405	450	500
2 - Top Tube (EFF)	625	648	693
3 - Head Tube	190	240	270
4 - Chainstay	510	510	510
5 - BB Height	272,5	272,5	272,5
6 - BB Drop	95	95	95
7 - Wheelbase	1163	1187	1233
8 - Head Angle	70°	70°	70°
9 - Seat Angle	72°	72°	72°
11 - Reach	397	405	440
12 - Stack	662	709	737
13 - Fork Length	433	433	433

HEIGHT (cm)	HEIGHT (in)	SIZE
150-165	59.1"-65.0"	S
165-180	65.0"-70.9"	M
180-200	70.9"-78.7"	L

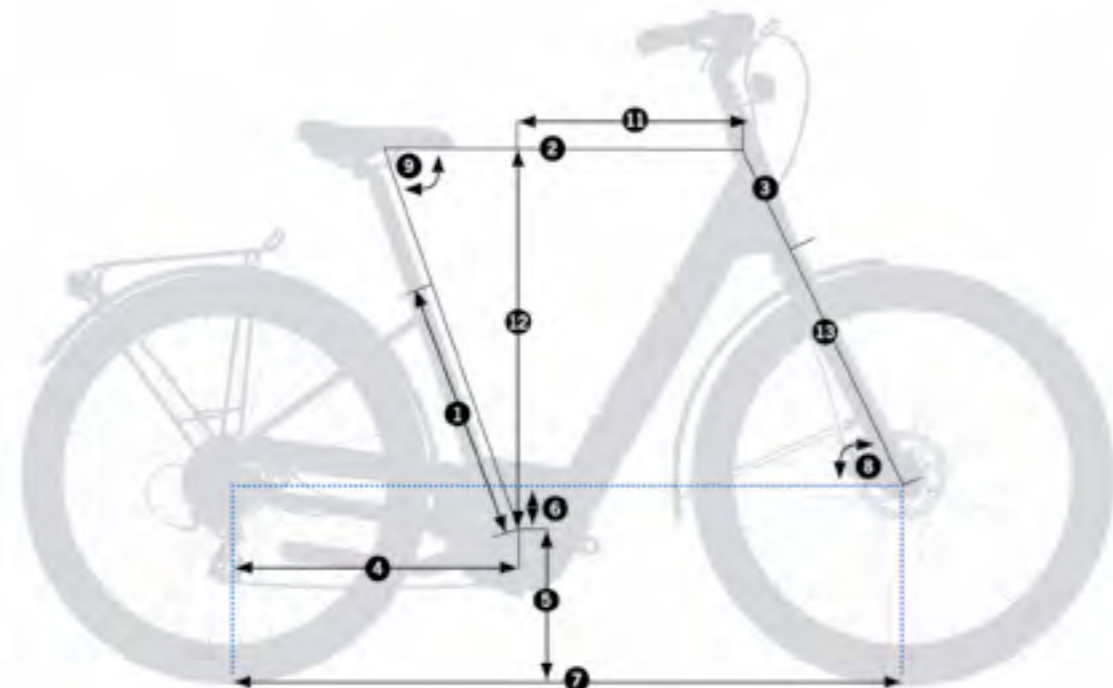
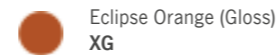

## OPTIMA E40

MyO<sub>2.0</sub>

Code	J345		
Size	Crank	Stem	Handlebar
S	152	60	640
M	152	60	640
L	152	60	640



<b>Frame</b>	Orbea Optima Hydroformed Alloy, Ebikemotion X35 internal battery
<b>Fork</b>	Optima 400mm Alloy Post mount
<b>Crankset</b>	Prowheel PRA-105 42t
<b>Headset</b>	1-1/8" Semi-Integrated
<b>Handlebar</b>	Orbea City Riser Alu 640mm
<b>Stem</b>	Orbea TDS-D617
<b>Shifters</b>	Shimano Altus M2000
<b>Brakes</b>	Shimano MT200 Hydraulic Disc
<b>Rear Derailleur</b>	Shimano Altus M2000 SGS Shadow
	Shimano XT M781 11-36t 10v
<b>Chain</b>	KMC e9 Turbo Silver
<b>Wheels</b>	Airline Corsa
<b>Cassette</b>	Shimano HG200 11-36 9-Speed



<b>Hub</b>	Safety Lock
<b>Tyres</b>	Kenda 1172 700x50c
<b>Pedals</b>	VP-856 Black
<b>Seatpost</b>	Orbea OC 31.6x400mm
<b>Saddle</b>	Selle Royal Milo Plus DR
	Selle Royal Looking Moderate DRO 3D Gel
<b>Rear carrier</b>	Orbea Optima hidden stays
<b>Mudguard</b>	Orbea SKS EDGE Alu C56R
<b>Front light</b>	Joss Spanninga Kendo Steps
<b>Rear light</b>	Joss Spanninga Lineo XDS Dinamo
<b>Chainguard</b>	Orbea Optima
<b>Lock</b>	
	Abus Pro Shield Plus frame lock
<b>Quick stand</b>	Ursus Power single central adjustable

<b>Motor</b>	Ebikemotion X35
<b>Battery</b>	Ebikemotion 36V/6.9A
	Ebikemotion Extra External Battery 208Wh
<b>Remote 2</b>	Ebikemotion iWoc TRIO

## OPTIMA E50

MyO<sub>2.0</sub>

Code	J344		
Size	Crank	Stem	Handlebar
S	152	60	640
M	152	60	640
L	152	60	640



<b>Frame</b>	Orbea Optima Hydroformed Alloy, Ebikemotion X35 internal battery
<b>Fork</b>	Optima 400mm Alloy Post mount
<b>Crankset</b>	Prowheel PRA-105 42t
<b>Headset</b>	1-1/8" Semi-Integrated
<b>Handlebar</b>	Orbea City Riser Alu 640mm
<b>Stem</b>	Orbea TDS-D617
<b>Shifters</b>	Shimano M310
<b>Brake levers</b>	Shimano Alivio BL-T4010
<b>Brakes</b>	Shimano TX805 Mechanical Disc
<b>Rear Derailleur</b>	Shimano Altus M310
<b>Chain</b>	KMC X8
<b>Wheels</b>	Airline Corsa
<b>Cassette</b>	Shimano HG200 12-32t 8-Speed



<b>Hub</b>	Safety Lock
<b>Tyres</b>	Kenda 1172 700x50c
<b>Pedals</b>	VP-856 Black
<b>Seatpost</b>	Orbea OC 31.6x400mm
<b>Saddle</b>	Selle Royal Milo Plus DR
	Selle Royal Looking Moderate DRO 3D Gel
<b>Rear carrier</b>	Orbea Optima hidden stays
<b>Mudguard</b>	Orbea SKS EDGE Alu C56R
<b>Front light</b>	Joss Spanninga Kendo Steps
<b>Rear light</b>	Joss Spanninga Lineo XDS Dinamo
<b>Chainguard</b>	Orbea Optima
<b>Lock</b>	
	Abus Pro Shield Plus frame lock
<b>Quick stand</b>	Ursus Power single central adjustable

<b>Motor</b>	Ebikemotion X35
<b>Battery</b>	Ebikemotion 36V/6.9A
	Ebikemotion Extra External Battery 208Wh
<b>Remote 2</b>	Ebikemotion iWoc TRIO

## OPTIMA BOSCH

SIZES	S-M	L-XL
1 - Seat Tube (C-T)	505	552
2 - Top Tube (EFF)	593	621
3 - Head Tube	170	210
4 - Chainstay	398	398
5 - BB Height	262	262
6 - BB Drop	93	93
7 - Wheelbase	1172	1182
8 - Head Angle	67°	69°
9 - Seat Angle	74.4°	74.4°
11 - Reach	368	384
12 - Stack	659	706
13 - Fork Length	460	460

HEIGHT (cm)	HEIGHT (in)	SIZE
160-182	63.0"-71.7"	S/M
>177	>69.7"	L/XL

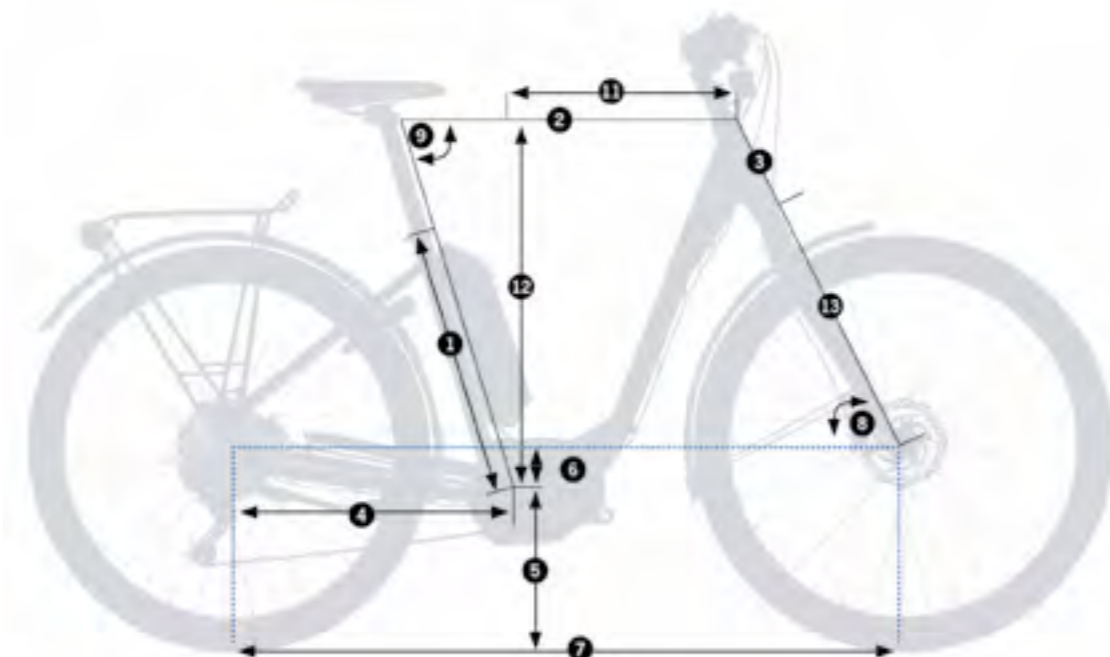
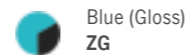
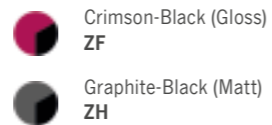
OPTIMA ASPHALT 10 *MyO.200*

Code	J348		
Size	Crank	Stem	Handlebar
S/M	152	90	660
L/XL	152	90	660



Frame	Orbea Optima Hydroformed Alloy, Bosch Gen2/Gen3 Powerpack
Fork	Orbea Optima
Crankset	Alloy 18t
Crank	Miranda Delta 152mm
Headset	1-1/8" Semi-Integrated
Handlebar	Orbea Comfort Riser Alu 660mm
Grips	Ergonomic w/lock
Stem	Orbea Black Adjustable
Shifters	Shimano XT M8000
Brakes	Shimano MT201 Hydraulic Disc
Rear Derailleur	Shimano XT M8000 GS Shadow Plus
Chain	KMC e11 Turbo Silver
Wheels	Orbea Black Rock 23c Disc



Cassette	Sun Race 11-46t 11-Speed
Hub	Safety Lock
Tyres	Kenda 1052 29x2.0
Pedals	VP-615 Black
Seatpost	Orbea OC-I 31.6x400mm
Saddle	Selle Royal Looking Moderate DRO 3D Gel
Rear carrier	Orbea Optima hidden stays
Mudguard	Orbea SKS EDGE Alu C56R
Front light	Joss Spanninga Axendo XE
Rear light	Spanninga Lineo
Chainguard	Horn Catena 14 ES Bosch Long
Lock	Abus Pro Shield Plus+battery downtube lock
Quick stand	Yuen I YRA-60B Kickstand

Motor	BOSCH Performance CX 25 kmh
Battery	BOSCH Performance 500Wh
Display	BOSCH Performance Purion

OPTIMA ASPHALT 20 *MyO.200*

Code	J347		
Size	Crank	Stem	Handlebar
S/M	152	90	660
L/XL	152	90	660



Frame	Orbea Optima Hydroformed Alloy, Bosch Gen2/Gen3 Powerpack
Fork	Orbea Optima
Crankset	FSA Bosch-IG3 E-bike 44t
Crank	Miranda Delta 152mm
Headset	1-1/8" Semi-Integrated
Handlebar	Orbea Comfort Riser Alu 660mm
Stem	Orbea Black Adjustable
Shifters	Shimano SL-C6000 Nexus 8-Speed
Brakes	Shimano MT200 Hydraulic Disc
Chain	KMC Z510HX
Wheels	Orbea Black Rock 23c Disc
Cassette	Shimano Nexus 18t
Hub	Safety Lock



Tyres	Kenda 1052 29x2.0
Pedals	VP-615 Black
Seatpost	Orbea OC-I 31.6x400mm
Saddle	Selle Royal Milo Plus DR
Rear carrier	Selle Royal Looking Moderate DRO 3D Gel PORTABULTOS DE ACERO PARA RUEDAS DE 26 Y 28 NEGRO Orbea Optima Hidden stays Carrier+SKS Edge C56R Mudguards
Mudguard	SKS 28" 65mm
Front light	Spanninga Kendo 15 lux Joss Spanninga Axendo XE
Rear light	Spanninga Lineo
Chainguard	Horn Catena A09/42-44

Lock	Abus Pro Shield Plus+battery downtube lock
Quick stand	Yuen I YRA-60B Kickstand
Motor	BOSCH Active Plus 25 kmh
Battery	BOSCH Performance 500Wh
Display	BOSCH Performance Purion

OPTIMA ASPHALT 30 *MyO.LSD*

Code	J346		
Size	Crank	Stem	Handlebar
S/M	152	90	660
L/XL	152	90	660



<b>Frame</b>	Orbea Optima Hydroformed Alloy, Bosch Gen2/Gen3 Powerpack
<b>Fork</b>	Orbea Optima
<b>Crankset</b>	FSA Bosch-IG3 E-bike 44t
<b>Crank</b>	Miranda Delta 152mm
<b>Headset</b>	1-1/8" Semi-Integrated
<b>Handlebar</b>	Orbea Comfort Riser Alu 660mm
<b>Stem</b>	Orbea Black Adjustable
<b>Shifters</b>	Sturmey Archer TSC50 5-Speed Twist
<b>Brakes</b>	Shimano MT200 Hydraulic Disc
<b>Chain</b>	KMC Z510HX
<b>Wheels</b>	Orbea Black Rock 23c Disc
<b>Cassette</b>	Sturmey Archer CSIRW 18t
<b>Hub</b>	Safety Lock

<b>Tyres</b>	Kenda 1052 29x2.0
<b>Pedals</b>	VP-615 Black
<b>Seatpost</b>	Orbea OC-I 31.6x400mm
<b>Saddle</b>	Selle Royal Milo Plus DR
<b>Rear carrier</b>	PORTABULTOS DE ACERO PARA RUEDAS DE 26 Y 28 NEGRO
	Orbea Optima Hidden stays Carrier+SKS Edge C56R Mudguards
<b>Mudguard</b>	SKS 28" 65mm
<b>Front light</b>	Spanninga Kendo 15 lux
	Joss Spanninga Axendo XE
<b>Rear light</b>	Spanninga Lineo
<b>Chainguard</b>	Horn Catena A09/42-44

<b>Lock</b>	Abus Pro Shield Plus+battery downtube lock
<b>Quick stand</b>	Yuen I YRA-60B Kickstand
<b>Motor</b>	BOSCH Active 25 kmh
<b>Battery</b>	BOSCH Performance 400Wh
<b>Display</b>	BOSCH Performance Purion

OPTIMA COMFORT 10 *MyO.LSD*

Code	J351		
Size	Crank	Stem	Handlebar
S/M	152	90	660
L/XL	152	90	660



<b>Frame</b>	Orbea Optima Hydroformed Alloy, Bosch Gen2/Gen3 Powerpack
<b>Fork</b>	Zoom monoshox CH106 Disc
<b>Crankset</b>	Alloy 18t
<b>Crank</b>	Miranda Delta 152mm
<b>Headset</b>	1-1/8" Semi-Integrated
<b>Handlebar</b>	Orbea Comfort Riser Alu 660mm
<b>Stem</b>	Orbea Black Adjustable
<b>Shifters</b>	Shimano XT M8000
<b>Brakes</b>	Shimano MT201 Hydraulic Disc
<b>Rear Derailleur</b>	Shimano XT M8000 GS Shadow Plus
<b>Chain</b>	KMC e11 Turbo Silver
<b>Wheels</b>	Orbea Black Rock 23c Disc
<b>Cassette</b>	Sun Race 11-46t 11-Speed

<b>Hub</b>	Safety Lock
<b>Tyres</b>	Kenda K935 1,65" Reflex
<b>Pedals</b>	VP-615 Black
<b>Seatpost</b>	Orbea 31.6x350mm w/Suspension
<b>Saddle</b>	Selle Royal Looking Moderate DRO 3D Gel
<b>Rear carrier</b>	Orbea Optima hidden stays
<b>Mudguard</b>	Orbea SKS EDGE Alu C56R
<b>Front light</b>	Joss Spanninga Axendo XE
<b>Rear light</b>	Spanninga Lineo
<b>Chainguard</b>	Horn Catena 14 ES Bosch Long
<b>Lock</b>	Abus Pro Shield Plus+battery downtube lock
<b>Quick stand</b>	Yuen I YRA-60B Kickstand
<b>Motor</b>	BOSCH Performance CX 25 kmh

<b>Battery</b>	BOSCH Performance 500Wh
<b>Display</b>	BOSCH Performance Purion

OPTIMA COMFORT 20 *MyO.LSD*

Code	J350		
Size	Crank	Stem	Handlebar
S/M	152	90	660
L/XL	152	90	660



<b>Frame</b>	Orbea Optima Hydroformed Alloy, Bosch Gen2/Gen3 Powerpack
<b>Fork</b>	Zoom monoshox CH106 Disc
<b>Crankset</b>	FSA Bosch-IG3 E-bike 44t
<b>Crank</b>	Miranda Delta 152mm
<b>Headset</b>	1-1/8" Semi-Integrated
<b>Handlebar</b>	Orbea Comfort Riser Alu 660mm
<b>Stem</b>	Orbea Black Adjustable
<b>Shifters</b>	Shimano Deore M6000
<b>Brakes</b>	Shimano MT200 Hydraulic Disc
<b>Rear Derailleur</b>	Shimano Deore M6000 GS Shadow Plus
<b>Chain</b>	KMC e10 Turbo Silver
<b>Wheels</b>	Orbea Black Rock 23c Disc
<b>Cassette</b>	Shimano HG50 11-36t 10-Speed

<b>Hub</b>	Safety Lock
<b>Tyres</b>	Kenda K935 1,65" Reflex
<b>Pedals</b>	VP-615 Black
<b>Seatpost</b>	Orbea 31.6x350mm w/Suspension
<b>Saddle</b>	Selle Royal Milo Plus DR
<b>Rear carrier</b>	PORTABULTOS DE ACERO PARA RUEDAS DE 26 Y 28 NEGRO
	Orbea Optima Hidden stays Carrier+SKS Edge C56R Mudguards
<b>Mudguard</b>	SKS 28" 65mm
<b>Front light</b>	Spanninga Kendo 15 lux
	Joss Spanninga Axendo XE
<b>Rear light</b>	Spanninga Lineo
<b>Chainguard</b>	Horn Catena A09/42-44

<b>Lock</b>	Abus Pro Shield Plus+battery downtube lock
<b>Quick stand</b>	Yuen I YRA-60B Kickstand
<b>Motor</b>	BOSCH Active Plus 25 kmh
<b>Battery</b>	BOSCH Performance 500Wh
<b>Display</b>	BOSCH Performance Purion

OPTIMA COMFORT 30 *MyO.LSD*

Code	J349		
Size	Crank	Stem	Handlebar
S/M	152	90	660
L/XL	152	90	660



<b>Frame</b>	Orbea Optima Hydroformed Alloy, Bosch Gen2/Gen3 Powerpack
<b>Fork</b>	Zoom monoshox CH106 Disc
<b>Crankset</b>	FSA Bosch-IG3 E-bike 44t
<b>Crank</b>	Miranda Delta 152mm
<b>Headset</b>	1-1/8" Semi-Integrated
<b>Handlebar</b>	Orbea Comfort Riser Alu 660mm
<b>Stem</b>	Orbea Black Adjustable
<b>Shifters</b>	Shimano Altus M2000
<b>Brakes</b>	Shimano MT200 Hydraulic Disc
<b>Rear Derailleur</b>	Shimano Altus M2000 SGS Shadow
<b>Chain</b>	KMC e9 Turbo Silver
<b>Wheels</b>	Orbea Black Rock 23c Disc
<b>Cassette</b>	Shimano HG200 11-36t 9-Speed

<b>Hub</b>	Safety Lock
<b>Tyres</b>	Kenda K935 1,65" Reflex
<b>Pedals</b>	VP-615 Black
<b>Seatpost</b>	Orbea 31.6x350mm w/Suspension
<b>Saddle</b>	Selle Royal Milo Plus DR
<b>Rear carrier</b>	PORTABULTOS DE ACERO PARA RUEDAS DE 26 Y 28 NEGRO
	Orbea Optima Hidden stays Carrier+SKS Edge C56R Mudguards
<b>Mudguard</b>	SKS 28" 65mm
<b>Front light</b>	Spanninga Kendo 15 lux
	Joss Spanninga Axendo XE
<b>Rear light</b>	Spanninga Lineo
<b>Chainguard</b>	Horn Catena A09/42-44

<b>Lock</b>	Abus Pro Shield Plus+battery downtube lock
<b>Quick stand</b>	Yuen I YRA-60B Kickstand
<b>Motor</b>	BOSCH Active 25 kmh
<b>Battery</b>	BOSCH Performance 400Wh
<b>Display</b>	BOSCH Performance Purion



# HELMETS

R10 AERO MIPS

R10 MIPS

R50

M50

H10

YOUTH

KIDS



## R10 AERO MIPS

Wind tunnel tests have shown that a helmet's profile and volume are more important than the number (or even the lack) of air vents when it comes to reducing drag. If the shape of the helmet is closely adjusted to the rider's head and doesn't lie too far above the skull, the helmet will produce more efficient results than a standard high-volume helmet. A screen or visor can further reduce resistance, so that a well-vented helmet can be as aerodynamic as a helmet with larger volume and no vents. There's no reason to compromise air flow for reduced wind resistance. With its reduced volume and carefully optimized shape, the R10 performs extremely well in both departments.

Code	H15ETTCC
Size	M, L



### WHAT MAKES R10 AERO MIPS UNIQUE?

- / AERODYNAMICS MIPS
- / COMFORT
- / VENTILATION
- VENTILATION - ES INDEX
- VENTILATION - ITP INDEX

- / CHARACTERISTICS
- EPS SHELL
- POLYCARBONATE INJECTION IN-MOLD
- ERGONOMIC RETENTION SYSTEM

### COLORS



Black  
HH



Red  
HQ



Blue  
HR



White  
HB



## R10 MIPS

“The professional riders rely on the new R10 for protection, aerodynamics, light weight and ventilation in high-performance competition. The R10 is our flagship helmet. We’ve exploited the latest construction technologies, made numerous visits to the wind tunnel and paid the closest attention to every single detail.

Our four-layer TC Technology (EPS foam core, molded polycarbonate shell, nylon mesh, and carbon fiber) yields

an exceptionally comfortable and low-mass helmet with amazing ventilation properties. The nylon and carbon fiber internal layers reinforce the helmet’s structure, making the R10 15% lighter than Odin and significantly more compact. Shock resistance is improved and the new R10 is 3% more aerodynamically efficient than standard road helmets.”

Code	H14ETTCC
Size	S, M, L



### WHAT MAKES R10 MIPS UNIQUE?

/ COMPACT DESIGN

/ MIPS

/ VENTILATION  
VENTILATION - ES INDEX  
VENTILATION - ITP INDEX

/ COMFORT

/ CHARACTERISTICS  
POLYCARBONATE INJECTION IN-MOLD  
EPS SHELL  
ERGONOMIC RETENTION SYSTEM

### COLORS



Black  
HH



White-Black  
HD



Navy-Blue-Orange  
H9



Jade  
HE



Turquoise  
HJ



# R50

The R50 is based on the same minimal-volume philosophy as the R10 but features simpler construction and shaping to bring high performance to a wider range of riders. In fact, its unique design is a statement in its own right, ensuring unrivaled looks and comfort on the bike. The low internal touch point (ITP) index translates into fewer points of contact inside the helmet for a great feel and improved ventilation. The 19 vents keep your head cool so you can feel the wind while being safe, wearing a durable three-layer TC Construction helmet. Breathable pads and inner mesh fabric wick moisture away, keeping you fresh for hours during summer climbs. The adjustment dial of the fastening mechanism can be manipulated quickly with one hand so you'll only have to focus on the road ahead.

Code	H10ETTCC
Size	S, M, L



## WHAT MAKES R50 UNIQUE?

- 01/ IMPROVED VENTILATION
- 02/ LIGHTER WEIGHT
- 03/ AERODYNAMICS

/ CHARACTERISTICS  
 POLYCARBONATE INJECTION IN-MOLD  
 ERGONOMIC RETENTION SYSTEM

## COLORS



Turquoise  
HK



Jade Black  
HF



White Navy Blue  
HC



White Black  
HD



Navy Blue Orange  
H9



# M50

The M50 is ready for adventure. The EPS foam core and molded polycarbonate shell were developed using our two-layer TC Technology to combine low weight and durability. The M50 has 23 vents to maximize air flow and comfort in hot weather. Like the rest of our helmets, the M1 features Coolmax pads for optimal cushioning. The removable visor and easy-to-use fit adjustment dial allow quick customization for every rider.

Code	H17ETTCC
Size	M, L



## WHAT MAKES M50 UNIQUE?

/ POLYCARBONATE INJECTION  
IN-MOLD  
/ ERGONOMIC RETENTION SYSTEM

/ SINGLE HAND MICRO-ADJUST

## COLORS



Black-White  
HI



Navy-Blue-Green  
HA



Jade-Red  
HG



Purple-Jade  
HN





# H10

The new H10 is an economical though not necessarily basic helmet. It has many of the characteristics of the more expensive helmets in our range, including stylish, smooth design and optimal ventilation. The low internal touch point (ITP) index translates to fewer points of contact inside the helmet for greater comfort and improved airflow. With a reduced volume, the H10 doesn't feel too big or heavy but rather becomes an extension of your own body. 25 vents keep your head cool and enable you to feel the wind, while the two-layer TC Construction utilizes EPS foam and polycarbonate to keep the helmet sturdy and light. Breathable pads and inner mesh fabric are easy to clean and they wick moisture away, keeping you fresh for hours. The dial of the fastening mechanism can be adjusted easily with one hand.

Code	H11ETTCC
Size	M, L



## WHAT MAKES H10 UNIQUE?

- / POLYCARBONATE INJECTION IN-MOLD
- / ERGONOMIC RETENTION SYSTEM
- / SINGLE HAND MICRO-ADJUST

## COLORS



Black  
HH



Navy Blue  
H7



Jade  
HE



Dark green  
HL



White  
BB



# YOUTH

When you need to fit in, style is important but mom and dad insist on safety. The Sport Youth helmet can help with both. Like our adult M1, M2 and H10 helmets, it was developed using our 2-Layer TC Technology that fuses EPS foam and a polycarbonate shell, it is light and resistant. The Sport City has 15 vents to maximize air flow and comfort in hot weather and, like the rest of our helmets, features Coolmax pads for optimal cushioning and an easy-to-use fit adjustment dial that allows the helmet to grow with you.

Code	H13ETTCC
Size	UNIQUE



## COLORS



Blue  
H8



Violet  
HM



Jade  
HE



Green  
HP



## KIDS

Your kid doesn't need to know the Orbea Sport Kids helmet is for safety. They'll just love the alluring colors and feel comfortable wearing this cool helmet. Developed using our 2-Layer TC Technology that fuses EPS foam and a polycarbonate shell, it is light and resistant. The Sport City has 12 vents to maximize air flow and comfort in hot weather and, like the rest of our helmets, features Coolmax pads for optimal cushioning and an easy-to-use fit adjustment dial that allows the helmet to grow with you.

Code	H08ETTCC
Size	UNIQUE



## COLORS



Fuschia  
FF



Red  
RR



Green  
VV



Blue  
AA



WWW.ORBEA.COM



**ORBEA**

www.orbea.com